

Sorbonne University

Doctoral School of Informatics, Telecommunications and
Electronics of Paris

EURECOM

Multi-Service Resource Orchestration for Vehicular Safety Communication

Mohammad Irfan Khan

Dissertation for Doctor of Philosophy in Information and
Communication Engineering

Directed by Prof. Jérôme Härri

Publicly presented and defended on 12 December 2019

A Jury committee composed of:

Prof. Dr. Antonella Molinaro, Rapporteur
Prof. Dr. Jean-Marie Bonin, Rapporteur
Prof. Dr. Marcelo Dias de Amorim, Examineur
Prof. Dr. Härri Jérôme, Examineur
Prof. Dr. Adlen Ksentini, Examineur
Dr. John Kenney, Examineur
Dr. Sesia Stefania, Examineur

Abstract

Wireless channel congestion control and decentralized resource allocation for 802.11p based V2X communication have been widely investigated for a single Cooperative Awareness service, considering mostly homogeneous communication requirement per vehicle. Future connected vehicles will be based on multiple V2X services, with heterogeneous number of services and communication needs, which existing resource allocation mechanisms have not addressed.

In this thesis, we analyze several decentralized congestion control and channel resource allocation protocols standardized in Europe for initial V2X deployment. We present issues with the existing approach, in particular the inefficient channel capacity utilization, classification of V2X services using static priority for Quality of Service, resource allocation at the Access Layer, problematic cross layer coordination, inability to balance resources among multiple V2X safety services and distributed resource allocation for asymmetric number of services per vehicle.

We propose improvements to the shortcomings, considering key requirements for future connected vehicles supporting heterogeneous V2X services. We suggest modifications to Access Layer congestion control and propose shifting the in-vehicle resource allocation intelligence from the Access to the Service Layer. In this regard we design a resource orchestrator at the Service Layer, which dynamically characterizes services using multiple QoS parameters and allocates channel resources among V2X services in close coordination with the Access Layer. Similarly, we present a distributed mechanism to orchestrate channel resources among a mixed distribution of vehicles with diverse channel usage requirements under channel congestion.

Our proposed algorithms and design improvements increase the channel capacity usage, improve V2X safety information freshness, reduce starvation of lower priority services and decentrally allocate additional channel resources to nodes having more and higher priority V2X services. Analytical and simulation-based results show the V2X application performance improvement rendered by our approach, compared to existing standardized protocols.

Acknowledgements

I am thankful to my family, friends, colleagues, officemates and everybody who has been part of my PhD journey during the last 3 plus years. Firstly I would like to thank my advisor Prof. Jérôme Haerri for his guidance and supervision, despite his overcharged work schedule. In particular, the freedom and liberty allowed by him enabled me to learn to think and work autonomously.

I would like to thank Prof. Javier Gonzalez and Miguel Sepulcre for hosting me as a visiting student for several months at University of Miguel Hernandez in Spain. Besides, I would thank John Kenney and Hongsheng Lu of Toyota ITC, for their comments and research ideas from time to time. Similarly, I want to thank the jury members and the reviewers, Prof. Jean-Marie Bonin and Prof. Antonella Molinaro for taking the time to review the manuscript.

Moreover, I am grateful for the different projects and research contracts which partly funded my PhD work, notably HIGHTS H2020 project, the French-German research project AFA-SCHIEF, and a research grant from Renault SAS. Special thanks go to Stefania Sesia for the funding and research collaboration with Renault SAS.

Lastly, thanks to the Almighty for the luck and blessings all the way.

Contents

1	Introduction	1
1.1	Introduction	1
1.2	V2X communication: History and Overview	2
1.2.1	Research History in Europe	3
1.2.2	Research History in the USA	4
1.3	Applications & Use Cases of V2X communication	4
1.3.1	Safety Applications for Day 1 Scenario	5
1.3.2	Safety Applications for Day 2 Scenario	5
1.4	Transmission Technology & Spectrum	6
1.4.1	IEEE 802.11p based ITS-G5/DSRC	6
1.4.2	Channels & Frequency spectrum	6
1.5	Distributed Resource Allocation & Congestion Control	7
1.6	Research Problem	8
1.7	Research Methodology and Design Choices	9
1.8	Contribution	10
1.9	List of Publications	11
1.10	Organization of the thesis	12
2	State of the Art	14
2.1	Standardization Organizations	14
2.2	Standardized Protocol Stack in Europe and USA	16
2.2.1	Architecture - ETSI TC ITS	16
2.2.2	Architecture - IEEE 1609.4 WAVE	16
2.2.3	ETSI Facilities Layer & V2X Safety Messages	17
2.2.4	SAE Message Sub Layer & Standardized messages in the USA	22
2.2.5	ETSI Network & Transport Layer	23
2.2.6	IEEE Wave Network & Transport Layer	24
2.2.7	ETSI Access layer	25
2.2.8	IEEE Wave Access layer	27
2.2.9	3GPP LTE V2X	27
2.2.10	Cross Layer Entities	28
2.3	Channel Coexistence	28
2.4	Channel Congestion Control	31
2.4.1	ETSI Decentralized Congestion Control Standards	33
2.4.2	SAE Congestion Control Standard	35
2.5	Differences between standards in Europe and USA	36
2.6	Literature Review: Channel Congestion Control	37
2.6.1	Transmit Rate Control	38

2.6.2	Transmit Power Control	38
2.6.3	Combined Transmit Rate and Power Control	39
2.6.4	Controlling other parameters	39
2.6.5	Awareness Control	40
2.6.6	Channel Congestion Control for Multiple Packet Types	40
2.6.7	Beyond State of the Art	41
2.6.8	5.9 GHz Spectrum Sharing between ITS-G5/DSRC and other technologies	41
2.7	Existing Design Philosophy	43
2.7.1	Bottom Up Approach	43
2.7.2	Our Proposition: Top Down Approach	44
3	Problem Statement	45
3.1	Introduction	45
3.2	General Characteristics & Challenges of Vehicular Networks	45
3.2.1	Decentralization	45
3.2.2	Dynamicity	46
3.2.3	Heterogeneous Network Traffic Pattern	46
3.2.4	Heterogeneity in Communication Resource Requirement	47
3.2.5	Losing the dedicated spectrum for ITS communication	47
3.3	System Description & Key functions of Congestion Control	49
3.3.1	Inter-Vehicle Resource Allocation	50
3.4	In-Vehicle Transmit Rate Control	51
3.4.1	Classifying Services for limited channel resource Attribution	51
3.4.2	Access Layer Rate Control	53
3.4.3	Service/Facilities Layer Rate Control	57
3.5	Challenges of Inter Vehicle Transmit Rate Control	58
3.5.1	Asymmetric Resource demand by heterogeneous Nodes	58
3.5.2	Distributed Asymmetric Resource Allocation	59
3.6	Challenges of In Vehicle Transmit Rate Control	59
3.6.1	Limitations of Priority Queuing:	59
3.6.2	Limitations of Traffic Class and Access Category	59
3.6.3	Limitations of Access DCC Queuing Policy & Queue Size	60
3.6.4	Limitations of Channel Load Measurement	60
3.6.5	Limitations of Reactive Transmit Rate Control	61
3.6.6	Challenges of Cross-Layer Dependency	62
3.7	Paradigm Shift: Innovation and Methodology	66
3.7.1	Need for an In-Vehicle Resource Orchestrator	67
4	Results and Analysis	68
4.1	Introduction	68
4.2	Simulator & Simulation Scenario	68
4.2.1	iTetris-NS3 Network Simulator	68
4.2.2	Simulation Parameters	70
4.3	Access Layer Transmit Rate Control	71
4.3.1	Performance Benchmark: No Congestion Control	71
4.3.2	Reactive DCC - Earlier Version	72
4.3.3	Reactive DCC - Latest Version	74
4.3.4	Improving Reactive DCC	74

4.3.5	Adaptive DCC	79
4.4	DCC Access Queuing	81
4.4.1	Effect of Traffic Class & Packet Generation rate per Service	81
4.4.2	DCC Queuing: Same Traffic Class & Equal Packet Generation per Service	82
4.4.3	Effect of Queue Size	83
4.4.4	DCC Queuing Delay	84
4.5	DCC Cross Layer Coordination	85
4.5.1	Packet Generation Control via Transmit Rate Limit on top of Reactive Access DCC	87
4.5.2	Packet Generation Control via Transmit Rate Limit on top of Adaptive Access DCC	87
4.5.3	Packet Generation Control via Channel Resource Limit on top of Adaptive DCC	88
4.5.4	Facilities DCC on top of Improved Reactive DCC	89
4.6	Facilities Layer Resource Orchestration	91
4.6.1	Application characterization function	92
4.6.2	Application Resource Calculation	93
4.6.3	Packet Scheduling by the Resource Orchestrator	95
4.6.4	Resource Orchestration Performance Evaluation	97
4.7	Inter-Vehicle Resource Allocation (Asymmetric resource demand by vehicles)	99
4.7.1	Example of Distributed Resource Re-allocation	100
4.7.2	Resource Re-allocation Mechanism	100
4.7.3	Evaluation with Static Scenario	103
4.7.4	Evaluation with Dynamic Scenario	105
4.8	ITS-G5 & WiFi Spectrum Sharing	107
4.8.1	Performance Evaluation	107
4.8.2	Artificial Scenario: 3 Zones of Awareness	107
4.8.3	Scenario: Outdoor WiFi	109
4.8.4	Scenario: Indoor WiFi	110
5	Conclusions and Discussion	113
5.1	Summary of Problems Addressed and Contributions	113
5.1.1	DCC Access	113
5.1.2	DCC Queuing and Traffic Shaping	114
5.1.3	Design and Cross Layer Issues	115
5.1.4	Resource Orchestrator	116
5.1.5	Inter-Vehicle Asymmetric Resource Allocation	116
5.1.6	Spectrum Sharing	117
5.2	Future Work	118
5.2.1	In-vehicle resource allocation	118
5.2.2	Dynamic prioritization for Inter-vehicle resource allocation	119
5.2.3	Network Slicing for DSRC/ITS-G5	120
5.2.4	Machine learning for resource allocation	120
	Appendices	122

A	Machine Learning for V2X message prediction	123
A.1	Introduction	123
A.2	Resource Management in IEEE 802.11p based Vehicular Network	124
A.2.1	Issues with existing Approaches	125
A.3	Intelligent Scheduling via Machine Learning	125
A.3.1	Machine Learning for Predicting Neighbors' Transmissions	127
A.3.2	Design of the Predictor	127
A.3.3	Features selection and preparation	128
A.4	Evaluation	128
A.5	Conclusion	133

List of Figures

1.1	VRU detection via Cooperation Perception, image source C2C-CC [1]	5
1.2	ITS Spectrum in 5 GHz band in Europe	7
1.3	(a) DCC Architecture (b) Zoomed in view of DCC Queuing	8
2.1	ETSI Station Architecture	16
2.2	WAVE Protocol Stack	17
2.3	Facilities Layer Architecture, Image source [2]	17
2.4	V2V Services for Day 1	18
2.5	Structure of a CAM, image source ETSI EN 302 637-2 [3]	19
2.6	Electronic Emergency Brake Light Warning	20
2.7	Heterogeneous V2V Services for Day 2	21
2.8	Maneuver Coordination, image source [4]	22
2.9	Wave Short Message Format (Image via Creative Commons)	24
2.10	WiFi & ITS Spectrum Sharing in 5.7 - 5.9GHz band	29
2.11	Detect and Mitigate State Machine	30
2.12	Detect and Vacate State Machine	30
2.13	Detect and Vacate phases of CCA and transmission	31
2.14	DCC as Cyber-Physical System	32
2.15	Channel Busy Ratio	32
2.16	SAE Congest Control Algorithm	36
3.1	Block Diagram for dynamicity in vehicular communication	47
3.2	Three Zones of visibility between ITS-G5 and WiFi	49
3.3	Transmit Rate Control Block Diagram	50
3.4	Conceptual representation of In Vehicle and Inter Vehicle Resource Allocation	51
3.5	Congestion Control Stack Diagram	53
3.6	Reactive Transmit Rate Control State Machine, Image Source [5]	55
3.7	Theoretical Maximum Transmit Rate allowed by Reactive Access DCC for different combination of node density and packet size	61
3.8	Theoretical Maximum Transmit Rate allowed by CRL control for different combination of node density and packet size for a Channel Load Limit of 60%	62
3.9	Coordination between Service and Access Layer Rate Control for single message	64
3.10	Coordination delay between Service and Access Layer Rate Control for multiple messages with same DCC Profile	64
3.11	Coordination delay between Service and Access Layer Rate Control for multiple messages with different DCC Profile	65

LIST OF FIGURES

4.1	iTetris Network Simulator Architecture, Image source [6]	69
4.2	Number of Nodes sharing the channel for each simulation density	70
4.3	Application performance without DCC	72
4.4	Application performance with old Reactive DCC (TS 102 687 V 1.1.1)	73
4.5	Application performance with Reactive DCC (TS 102 687 V 1.2.1)	75
4.6	Application performance with Reactive DCC, One and Two Applications per Node	76
4.7	Continuous Channel Resource Limit vs Channel Load for Reactive DCC	76
4.8	Performance of Improved Reactive DCC, with rate control starting at 30% CL	77
4.9	Continuous CRL vs CL for Reactive DCC	78
4.10	Performance of Improved Reactive DCC, with rate control starting at 40% CL	79
4.11	Application performance with Adaptive DCC (TC 2 for CAM and TC 3 for CPM)	80
4.12	DCC Queue	81
4.13	Application performance with Adaptive DCC, same TC for CAM and CPM	82
4.14	ITT with Adaptive DCC, same TC for CAM and CPM, same packet generation rate	83
4.15	Application performance with Adaptive DCC, with queue size = 10	83
4.16	Time spent by all packets (transmitted and non-transmitted) in DCC queue	84
4.17	PGC via TRL on top of Reactive Access DCC	86
4.18	PGC via TRL on top of Adaptive Access DCC	88
4.19	PGC via CRL on top of Adaptive Access DCC	89
4.20	PGC via CRL on top of Improved Reactive Access DCC	90
4.21	Resource Orchestrator Block Diagram	91
4.22	Orchestrator in the ETSI ITS Stack	91
4.23	DCC Access Queue delay, using PGC vs Resource Orchestrator	98
4.24	Performance using Channel Resource Limit Control and Resource Orchestrator	98
4.25	Hidden Nodes and Non-homogeneous spatial distribution of messages	102
4.26	Performance of Adaptive DCC with equal resource allocation to Nodes	103
4.27	Asymmetric resource allocation, more resource to nodes with 2 services	105
4.28	Asymmetric resource allocation, highway scenario	106
4.29	CAM PRR for 3 Zones of Awareness	108
4.30	Three Zones of visibility between ITS-G5 and WiFi	108
4.31	CAM PRR for Outdoor WiFi	110
4.32	Scenario Outdoor WiFi, ITS-G5 in LOS with WiFi	110
4.33	CAM PRR for Indoor WiFi	111
4.34	Scenario Indoor WiFi, ITS-G5 in NLOS with WiFi	111
4.35	CAM PRR for Indoor WiFi Reduced Power	112
A.1	Transmission deferred to period of low channel activity	126
A.2	Learning Distance of Intelligent Node	126
A.3	Predictor Architecture	127
A.4	Packet Reception Ratio of 10 Hz Periodic CAMs	130

A.5	Packet Reception Ratio of Triggered CAMs for vehicle speed of 35-45 m/s	131
A.6	Packet Reception Ratio of Triggered CAMs for vehicle speed of 20-30 m/s	131
A.7	Packet Reception Ratio of Two Applications CAM and CPM	131
A.8	Packet Reception Ratio of Three Applications CAM, CPM, LDM .	132

List of Tables

2.1	V2X Messages in the USA, standardized by SAE	23
2.2	Data Rates supported by IEEE 802.11p	26
2.3	Detect and Mitigate EDCA parameters	30
2.4	DCC Standards in Europe	33
2.5	Rate Control Parameters for Reactive Access DCC in C2C-CC specification[7]	34
2.6	A comparison of related work w.r.t problems addressed in this thesis	42
3.1	Traffic classes for ITS-G5, source[8]	52
3.2	ITS-G5 Access Categories	53
3.3	Rate Control Parameters suggested by Reactive Access DCC of ETSI [5]. The EU commission's Delegated Act[9], specifies the Toff values for 500 μ s packet air time, regardless of the packet size.	55
3.4	Rate Limits for different ETSI DCC Profiles, as specified in [104] .	57
4.1	Simulation Parameters	71
4.2	Rate Control Parameters for Reactive DCC V1.1.1 [10]	73
4.3	Transmit Rate Control Parameters of ETSI Reactive DCC [5]	75
4.4	Our proposed Channel Resource Limit Control Parameters	75
4.5	CRL Control Parameters starting at 40% CL	78
4.6	Rate Limits for different ETSI DCC Profiles	85
4.7	DCC Cross Layer Issues solved by the proposed Resource Orchestrator	91
4.8	Scheduling Example by the Resource Orchestrator (The color is to highlight which packet is being transmitted each time)	95
4.9	Simulation Parameters	108
4.10	Detect and Mitigate EDCA parameters	109
5.1	DCC Cross Layer Issues solved by the proposed Resource Orchestrator	116
A.1	Simulation Parameters	129
A.2	Average Channel Load for different transmit Patterns	130

Acronyms

BSM	Basic Safety Message
C2C-CC	Car2Car Communication Consortium
CACC	Cooperative Adaptive Cruise Control
CAM	Cooperative Awareness Message
CL	Channel Load
C-ITS	Cooperative Intelligent Transportation Systems
CPM	Cooperative Perception Message
CRL	Channel Resource Limit
C-V2X	Cellular-V2X
DCC	Decentralized Congestion Control
DCF	Distributed Coordination Function
DENM	Decentralized Environmental Notification Message
DSRC	Dedicated short-range communications
FCC	Federal Communications Commission
EDCA	Enhanced Distributed Channel Access
ETSI	European Telecommunications Standards Institute
EU	European Union
GNSS	Global Navigation Satellite System
GPS	Global Positioning System
HAD	Highly Automated Driving
ITS	Intelligent Transportation System
MAC	Medium Access Control
NHSTA	National Highway Traffic Safety Administration

LIST OF TABLES

OBU	Onboard Unit
PHY	Physical layer
RSSI	Received Signal Strength Indicator
RSU	Road Side Unit
SAE	Society of Automotive Engineers
TRC	Transmit Rate Control
TRL	Transmit Rate Limit
VANET	Vehicular Ad hoc Network
VLC	Visible Light Communications
V2I	Vehicle to Infrastructure
V2V	Vehicle to Vehicle
V2X	Vehicle to Everything
WAVE	Wireless Access in Vehicular Environments

Chapter 1

Introduction

1.1 Introduction

Vehicular Networks are distributed, self-organized, highly mobile networks of vehicles, in which moving cars are nodes that communicate with each other and any existing infrastructure using wireless Vehicle-to-everything (V2X)¹ communication. Over the last several decades, it has been an active topic of research and standardization activities all over the world, and within the next couple of years V2X communication will be ubiquitous in our roads. It forms the potential core of Cooperative Intelligent Transport Systems (C-ITS), whose aim is to increase traffic safety, improve transport efficiency, reduce travel time, decrease carbon emission etc. through cooperation among vehicles and road users.

According to the World Health Organization, traffic accidents were the eighth leading cause of human deaths worldwide in 2018 [11], much higher than HIV, AIDS, tuberculosis etc. Therefore, one of the major aims of V2X has been to increase road safety by increasing a vehicle's awareness by communicating information beyond the driver's visual range and the vehicle's on-board sensors. This can be done by periodically exchanging awareness information via safety V2X messages such as Cooperative Awareness Messages (CAM) in EU or Basic Safety Messages (BSM) in the USA, and emergency event triggered messages such as Decentralized Environmental Notification Message (DENM). Awareness messages share vehicles' status information such as position, speed, heading etc, with neighboring vehicles, road users and road infrastructure.

Over the years, V2X networking protocols and communication technologies have been consolidated and is currently available for initial a.k.a Day 1 deployment. Among several potential wireless communication technologies, two leading technologies have been developed for V2X communication. The first technology, which is commercially available is called ITS-G5 in Europe and Dedicated short-range communications (DSRC) in the USA, with standardized PHY and MAC layers based on IEEE 802.11p. The other technology, called 3GPP Long-Term-Evolution (LTE) V2X, which albeit having a late entry into the ecosystem is becoming a major challenger to ITS-G5/DSRC.

The V2X connectivity in each vehicle, is used by a variety of applications and

¹The term V2X encompasses any type of communication involving vehicles and other entities, such as: V2V (vehicle-to-vehicle), V2I (vehicle-to-infrastructure), V2P (vehicle-to-pedestrian), V2D (vehicle-to-device) and so on.

services, in turn connected to the Human-Machine Interface (HMI) and other Electronic Control Units (ECU) inside the vehicle. Different applications have been analyzed over the years, and in 2016 the automotive industry completed the specification of vehicular communications standard for the first generation or Day 1 V2X applications. Similarly, research and standardization work for Day 1 use cases have been consolidated, where V2X communication will mostly involve a single type of broadcast/beaconing message, using a single 10 MHz channel and using one technology i.e. ITS-G5/DSRC.

In the future or Day 2 scenario, revolutionary V2X applications, such as highly automated driving (HAD) and safety of Vulnerable Road Users (VRU) will be based on a multitude of V2X services, such as Collective Perception (CP), Cooperative Adaptive Cruise Control (CACC), exchange of HD-maps etc. To reach that goal, vehicles will need to increase their awareness horizon, by acquiring the knowledge of the road environmental using their own embedded sensors i.e. Camera, Radar, Lidar, and the knowledge obtained by neighboring vehicles, shared via V2X communication.

To this aim, currently the industry and academia are investigating Day 2 applications and use cases, which will require more robust communication mechanisms to support such V2X applications and services, demanding much higher data rate and stringent latency guarantees. Several types of messages will be generated by Day 2 applications, which will strain the communication resources. In this regard, ITS-G5 has been criticized for having insufficient capacity, but in chapters 3 and 4 of this thesis we will show that it is also the inefficient channel usage for managing multiple types of services, which is equally problematic than the capacity limit.

Therefore one of the objectives of this thesis is to find more efficient ways of distributed resource allocation to accommodate multiple services and vehicles with heterogeneous communication requirements for Day 2 use cases. Similarly, due to the spectrum scarcity there will be concurrent technologies sharing the same spectrum, adding additional challenge for DSRC/ITS-G5 based V2X communication, which has also been analyzed in this thesis.

The rest of this chapter presents a brief history of research on V2X communication, followed by a high level description of the applications, communication technologies, frequency spectrum and channel congestion control. Then this chapter outlines the research problem of this thesis, along with the research methodology, contributions, list of publications and organization of the rest of this thesis.

1.2 V2X communication: History and Overview

The idea of Cooperative Vehicular Networks, initially called Vehicular Ad-hoc Network (VANET), has been forked from the idea of Mobile Ad hoc Networks (MANETs), and with MANETs researchers had an ultimate vision to allow mobile nodes to cooperatively form a network without infrastructure. This has been really challenging without coordination or configuration prior to setup of a MANET in addition to the frequent changing of network topology over a hostile communication medium with nodes having limited power and memory. Thus, out of the many potential application scenarios of MANETs, only VANET has been developed to be deployed in large scale.

In VANETs nodes tend to move in an organized fashion and the direction of

movement of nodes is predictable i.e. vehicles follow the direction of the road and can take better advantage of any network infrastructure. Similarly, nodes have better processing power, memory and batteries than MANETs. Moreover, the applications possible through V2X communication can lead to improved road safety, providing value added services and traffic management, thus motivating the industry, researchers and organizations to invest substantially in this domain.

1.2.1 Research History in Europe

In Europe, research work started in the late 1980s, and the first European project was called PROMETHEUS [12] (1987-1995), which worked on cooperative driving system using vehicular communication at the 57 GHz frequency band. This, was followed by other projects such as, CHAUFFEUR [13] (1996-2000), worked on platooning of trucks. The platoon leader was human driven, and the followers were driven via an electronic tow bar, using V2V communication to transmit deceleration information from the platoon leader to ensure string stability.

Since the beginning of this century, with the advent of GNSS navigation, Internet, hardware miniaturization and allocation of a dedicated frequency spectrum for ITS, a lot of Research and Development work, both in the academia and industry were initiated in the domain of V2X communication for increasing road safety, driver assistance, traffic management and alike. The German project FleetNet [14] (2000-2003), studied the feasibility of V2X communication based on IEEE 802.11 and UMTS terrestrial radio access (UTRA) to support several types of application with diverse networking requirements, i.e. cooperative driver assistance (safety), floating car data (traffic efficiency), and Internet access (infotainment). Its successor, another German project called Network on Wheels [15] (2004-2008), continued the work of FleetNet. It developed a dual protocol stack for ad-hoc communication between OBUs and OBU and RSU using 802.11p protocol for safety and traffic efficiency and 802.11a/b/g for communication with the infrastructure for infotainment. These projects contributed to early standardization work at European Telecommunications Standards Institute (ETSI) and Car2Car Communication Consortium (C2C-CC).

Similar projects followed, such as a project called SAFESPOT [16] between 2006-2010, which worked on V2X communication, safety application, precise relative localization and dynamic traffic map. Another project called GeoNet [17] was conducted between 2008-2010, which worked on combining IPv6 and geonetworking. A project called SEVECOM [18] looked into V2X security and privacy between the years 2006-2009. Another project called COMeSafety [19] was carried out between 2006-2010, which focused on harmonizing and consolidating research results, support standardization and frequency allocation. Most of these projects have contributed to the present V2X standards in Europe.

After the standardization phase, there have been several projects on prototyping and field operation tests. PRE-DRIVE C2X [20] (2008-2010) performed prototyping and feasibility study of a common European communication system. Its successor DRIVE C2X [21] (2011-2014) tested those on a large scale in seven test sites across Europe.

Finally, another project called Scoop@f [22] (2016-2018), was funded by the European Commission and French government with a goal to deploy 3000 connected

vehicles on 2000 km roads across 5 sites in Europe. It performed field tests of safety applications such as on-board signaling of dangerous events and road hazard warning.

1.2.2 Research History in the USA

Concurrently, in the USA, the academia and the industry have been actively engaged in Research and Development on ITS. In 1986, University of California Berkeley started a research program called California Partners for Advanced Transportation Technology (PATH)² to address challenges in California's surface transportation systems. Currently, it performs research in three domains, i.e. Transportation Safety, Traffic Operations and Modal Applications. Similarly in 1997, United States Department of Transportation (USDOT) started the Intelligent Vehicle Initiative [23], to develop integrated in-vehicle systems with a driver-centric viewpoint.

In 1999 after the availability of a dedicated spectrum of 75 MHz for ITS in the USA, a plethora of research activity took place in the domain of V2X communication. A project called Vehicular Safety Communication (VSC) [24] was carried out between 2002-2004 by 3 organizations i.e. USDOT, Crash Avoidance Metrics Partnership (CAMP) and Vehicle Safety Communications Consortium (VSCC). It defined the communication needs of safety applications and estimated the feasibility of Dedicated Short Range Communications (DSRC) to satisfy those needs.

Similarly a project called Vehicle Infrastructure Integration (VII) later known as IntelliDrive [25] (2004-2009) looked into V2V and V2I communication for crash avoidance applications and communications. The SafeTrip21 [26] project was carried out by the USDOT Research and Innovative Technology Administration (RITA) between 2008 and 2011 for testing and evaluating ITS applications for improving safety, reducing traffic congestion, improving traffic efficiency and transportation convenience. The IntelliDrive project was renamed as Connected Vehicle Research in 2011, and continued research on V2X communication for improving safety, mobility and reducing environmental effects.

The Connected Vehicle Safety Pilot project [27] (2011-2013) was carried out by University of Michigan Transportation Research Institute (UMTRI), CAMP and USDOT ITS program, which performed field tests to prove the benefit of V2X communication in urban scenarios on real drivers.

1.3 Applications & Use Cases of V2X communication

The objectives of V2X communication is to increase road safety, improve transportation efficiency, improve ride experience and provide additional services. To this aim, a basic set of applications have been envisioned for Day 1 scenario, which can be categorized as: active road safety, cooperative traffic efficiency and infotainment. Traffic efficiency applications provide information for navigation and better route selection, which has not been focused in this thesis. Safety applications intend to improve road safety and have been addressed in this thesis.

²www.path.berkeley.edu

1.3.1 Safety Applications for Day 1 Scenario

Safety applications aim to ensure general traffic safety on the road and inform drivers urgently in case of a road hazard or traffic emergency. They function by monitoring the vehicle’s own condition as well as the condition of other vehicles and the road itself, by receiving information via periodic or event triggered messages which complements and extends the range of its on-board sensors.

Safety applications such as Lane Change Warning (LCW) application, help a driver to maneuver carefully, or applications such as Road Hazard Signaling (RHS) increase a driver’s awareness and help the driver to take preventive action and avoid a danger. Similarly, they warn the driver of immediate emergency events, such as hard braking by a vehicle ahead, requiring immediate action to avoid collision. Examples of such applications are: Longitudinal Collision Risk Warning (LCRW), Co-operative Collision Avoidance (CCA), Electronic Emergency Brake Light (EEBL) etc.

1.3.2 Safety Applications for Day 2 Scenario

In future V2X deployment scenarios, the capability of sensors, the computational capacity and the level of autonomy of vehicles will increase, which will enable more advanced V2X applications for more challenging use cases. Highly Automated Driving (HAD) and Platooning are paramount use cases of future cooperative intelligent vehicles. In this regard, vehicles will need to establish a concept called ‘extended horizon’, where vehicles gather information outside the range of their built-in sensors, for example a hidden Vulnerable Road User (VRU) around the next building, through cooperative V2X communications and Day 2 safety applications such as Collective Perception. As shown in the example of Figure 1.1, the red vehicle detects pedestrians and emits a CP Message (CPM) [28], which alerts the white vehicle before making the right turn.

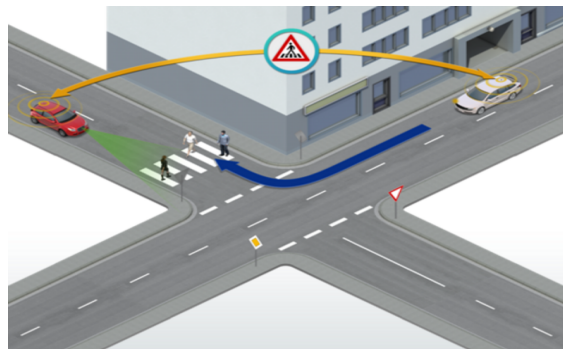

Figure 1.1: VRU detection via Cooperation Perception, image source C2C-CC [1]

Similarly, V2X communication capabilities will be used for cooperative driving and navigation, and it is expected that further applications will be developed to exchange a vehicle’s ‘trajectory intent’, i.e. for vehicles to negotiate and coordinate their maneuver, using Maneuver Coordination Message (MCM) [29]. Other use cases for future deployment include: vehicle sensor information and state map exchange, cooperative collision avoidance, remote driving, tactile internet, V2X connectivity for drones, bird’s eye view via drones etc.

These Day 2 applications will transmit a variety of messages in the channel, which will lead to channel congestion. In this thesis, we analyze that existing channel congestion control protocol standardized for Day 1, a.k.a Decentralized Congestion Control (DCC) in European standards, use the channel inefficiently. The main contribution of this thesis is to improve those congestion control protocols and propose better ones for managing multiple V2X safety messages in a congested channel.

1.4 Transmission Technology & Spectrum

As mentioned earlier, two leading wireless communication technologies have been developed for V2X communication: IEEE 802.11p based ITS-G5/DSRC and 3GPP LTE V2X.

1.4.1 IEEE 802.11p based ITS-G5/DSRC

ITS-G5/DSRC operates at the 5.9 GHz band, using IEEE 802.11p PHY and MAC layer protocol, which has been derived from IEEE 802.11a with modifications to adapt it to the dynamic context of V2X communication. At the PHY layer it uses Orthogonal Frequency Division Modulation (OFDM), with 52 subcarriers (48 data and 4 pilot subcarriers) which are placed within 10 MHz wide channels. Compared to 802.11a, the subcarrier spacing is halved (156.25 kHz instead of 312.5 kHz), which doubles the time domain parameters, to cope with Inter-Symbol Interference due to Multi-path fading in challenging propagation scenario.

The Medium Access of IEEE 802.11p uses the legacy IEEE 802.11 Carrier Sense Multiple Access with Collision Avoidance (CSMA/CA), listen before talk approach, having a different MAC functionality per channel. Similarly, for Quality of Service (QoS) 802.11 uses Enhanced Distributed Channel Access (EDCA) which originates from IEEE 802.11e-2005, offering 4 channel access priorities, i.e. Voice, Video, Best Effort and Background. Lastly, one key difference of 802.11p compared to infrastructure Wi-Fi is that it operates in an ad-hoc mode called Outside the context of a BSS (OCB). In this mode, nodes do not form a basic service set (BSS), and communicate on the fly to avoid the delay caused by network setup steps like channel scanning, authentication, and association. ITS-G5 will be detailed further in Chapter 2 of this thesis, along with the other Access technology, i.e. 3GPP LTE V2X.

1.4.2 Channels & Frequency spectrum

Since 2008, three 10 MHz channels have been allocated in Europe, for safety related applications at the 5.9 GHz band (called ITS-G5A at ETSI), with one CCH between 5895 and 5905 MHz and two SCHs between 5875 and 5895 MHz, as shown in Figure 1.2. Similarly, four additional channels have been reserved for ITS communication, called ITS-G5B (5855-5875 MHz) and ITS-G5D (5905-5925 MHz). Altogether, this makes a 70 MHz bandwidth between 5855 MHz and 5925 MHz reserved for ITS applications in Europe. Another ITS band called ITS-G5C actually corresponds

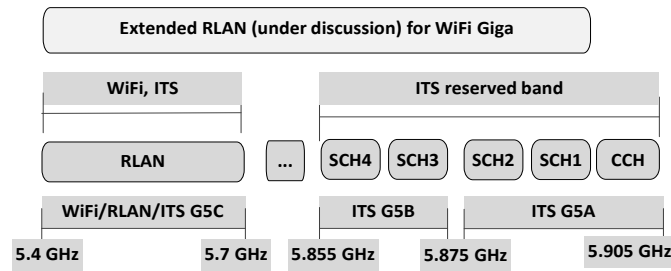

Figure 1.2: ITS Spectrum in 5 GHz band in Europe

to eleven 20 MHz channels of the lower RLAN band currently allocated for WiFi communication between 5.5 GHz to 5.72 GHz.

Although reserved since 1999 in the USA and 2008 in Europe, Day 1 connected and cooperative vehicle applications merely use one of these seven channels, the six others being planned for Day 2.

1.5 Distributed Resource Allocation & Congestion Control

In IEEE 802.11 based vehicular networks, there is no centralized channel resource allocator and the nodes need to prevent channel saturation by periodically monitoring the channel load, measured via Channel Busy Ratio (CBR), and limiting the spatial channel usage via Transmit Power Control (TPC) and/or temporal channel usage via Transmit Rate Control (TRC). In ETSI congestion control a.k.a DCC standards, TRC has been specified as the principle mechanism for congestion control at the Access layer [5].

DCC Access limits the transmit rate using traffic shaping at the Access Layer, via queuing and flow control above the EDCA queues, as a function of the CBR, as shown in Figure 1.3a. Packets from applications are enqueued in one of the four queues and are prioritized using Traffic Class (TC). Flow control is managed via a single leaky bucket for all the queues, which allocates transmit opportunity to a lower priority queue only if a higher priority queue has no packet. Figure 1.3b shows a zoomed in view of the queues with different V2X safety messages. CPM and MCM have been marked in grey as their exact priorities have not been specified in the standards.

The rate of the leaky bucket depends on the CBR, i.e. for higher CBR it allows a lower transmit rate and vice-versa. Similarly, the mapping of CBR to leaky bucket transmit rate can be of two variants, i.e. Reactive and Adaptive DCC. Reactive DCC maps the transmit rate to CBR using a state machine, while Adaptive DCC iteratively adapts the transmit rate to reach a target CBR. However, for the highest priority TC, the leaky bucket can be bypassed via a token bucket. DCC is being extended to be a cross-layer mechanism, with functionalities at the Facilities [30] and Network [31] layers and a cross-layer Management entity [32], which have been detailed in Chapters 2 and 3 of this thesis.

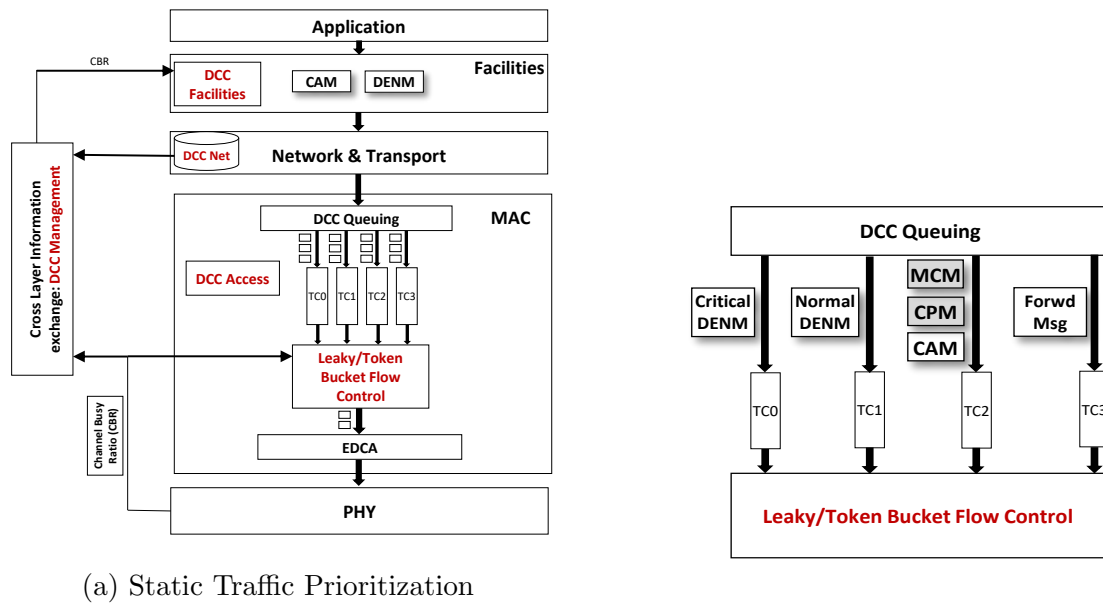

Figure 1.3: (a) DCC Architecture (b) Zoomed in view of DCC Queuing

By controlling the transmit rate of each node and of the services of a node, DCC can be seen as to allocate transmit opportunity or communication resources for each node and its services. Therefore, channel resource is allocated not only via CSMA/CA, but DCC additionally controls the resource allocation to each node on top of CSMA.

1.6 Research Problem

V2X channel congestion control has been investigated and standardized for initial V2X communication scenario, considering mostly a single type of safety message on the control channel. However, as discussed in Section 1.3, in future scenarios vehicles will broadcast a variety of messages, which will easily lead to channel congestion. This raises the following research problems which have been addressed in this thesis.

1. ETSI DCC uses the channel capacity inefficiently as found in several previous studies for a single message [33, 34], and multiple messages [35, 36]. The TRC has been found to be over aggressive, with an unstable control process. Although DCC has been revised recently [5], but some of the original problems with rate control with Reactive DCC still remain. **The first research problem is how to improve the performance and stability of Reactive DCC transmit rate control for multiple applications.**
2. There are 4 DCC queues for traffic shaping and flow control, as shown in Figure 1.3a. In future, a vehicle will transmit more than 4 types of messages. Therefore, messages from different applications will have to share the same queue, as shown in Figure 1.3b. However, at the Access layer there is no notion of application but only TC, so QoS cannot be enforced per application. Similarly, packets from one application may erase packets of other applications

waiting in the queue. **The second question is, how to provide QoS per application, instead of per TC and how to orchestrate channel resources among applications with homogeneous and heterogeneous priority.**

3. Prioritizing applications using static priority will indefinitely starve low priority applications during channel congestion. **The third problem is, how to dynamically characterize the priority of safety V2X applications, providing a node more control and flexibility for resource orchestration among multiple applications, instead of using static TC.**
4. In Day 2 scenario vehicles will have non-homogeneous capabilities and communication requirements. However, DCC allocates similar channel access opportunity to neighboring nodes facing similar channel load. **The fourth research problem is, how to decentrally distribute channel resources asymmetrically among vehicles with different needs and number of applications.**

1.7 Research Methodology and Design Choices

In this section we describe our approach to address and solve the aforementioned problems, along with the reasoning behind the design choices.

Step 1: Performance Improvement of DCC Rate Control

Firstly, we analyzed the performance of Access DCC for controlling transmit rate of multiple applications, and Reactive DCC uses inefficient rate control parameters along with non-optimal adaptation to channel load, resulting in an unstable control process. We propose less severe rate control parameters, with continuous and smooth rate adaptation using a memory, instead of abrupt rate oscillation of standardized DCC. This largely improves the transmit rate of multiple applications, controlled by Reactive DCC while limiting the channel load.

Step 2: Evaluation of DCC Traffic Shaping

Afterwards, we evaluated the impact of DCC queuing and traffic shaping. Several queuing methods were tested, and performance issues were found with those. Instead of queuing at the upper MAC layer, we concluded that the intelligence of traffic shaping should be shifted from the Access to the Service/Facilities Layer, which has higher intelligence and more flexibility to orchestrate channel access among the applications.

Step 3: Connecting Access DCC with the Service Layer

Reactive DCC limits transmit rate w.r.t CBR, without considering the packet duration, causing inefficiency as channel resource is a product of the transmit rate and duration. Although, the recently revised DCC standard [5] proposes rate limits for two packet duration ranges, but a lack of continuous relation of the packet duration, makes the Reactive Access DCC incompatible for managing multiple applications. Therefore, we included a third dimension, i.e. continuous function of the packet size to Reactive Access DCC, to make it compatible for handling multiple applications.

Similarly, spreading the DCC functionality at different layers, requires well coordination among those entities. ETSI has proposed cross-layer DCC mechanisms [32], but we observed issues in those protocols, resulting in missed transmit opportunities. We propose a resource orchestrator (discussed in Step 5) at the Facilities layer to mitigate the problem.

Step 4: Flexible & Dynamic Characterization of Applications

Using static QoS classes indefinitely starves low priority applications during channel capacity shortage. Therefore, we propose flexible characterization of V2X safety applications, to give each node more control for allocating channel resource among the applications. Similarly, the characterization depends on contextual factors, such as rank, usefulness and urgency, where no application can indefinitely be starved of transmit opportunity.

Step 5: Implementing a Service Layer Application Resource Orchestrator

Building on the previous steps, we propose a design to shift the traffic shaping intelligence, from the Access to the Service layer using a centralized in-vehicle resource orchestrator in the protocol stack, while leaving only the task of flow control at the Access layer.

The orchestrator characterizes applications according to Step 4, and allocates transmit opportunity among multiple applications using a budgetary scheduler based on resource earning/spending supporting a smooth resource allocation over time. It allows flexible adjustments in time of the priority between V2X services as a function of their dynamic budget.

Step 6: Resource Allocation for vehicles with Heterogeneous Needs

After dealing with in-vehicle resource allocation, we move to inter-vehicle resource allocation addressing the heterogeneous needs of each vehicle. We propose a cooperative and distributed mechanism for vehicles to identify the communication needs and importance of other vehicles sharing the channel, and sacrifice a proportional amount of resources from their own lower priority messages, which get used by vehicles with higher priority demands, while maintaining the overall channel load below the saturation level.

Step 7: Machine Learning for Predicting Resource Availability

Lastly, we also investigated using machine learning for predicting resource availability and application transmission patterns, in order to better allocate and reserve transmit opportunities for applications. Nevertheless, as the work is not mature enough to be integrated with the rest of this thesis, it has been put in the Appendix.

1.8 Contribution

The key contributions of this thesis can be summarized as follows:

1. We design an application resource orchestrator at the service layer.
-

2. We highlight the inadequacy of static traffic class for classifying safety V2X applications and propose dynamic prioritization using contextual parameters.
3. We demonstrate inefficiency of Reactive Access DCC, and improve its performance
4. We demonstrate issues of the ETSI DCC architecture, mainly Access layer queuing and flow control and highlight the necessity of a DCC entity at the Facilities Layer.
5. We demonstrate the challenges of cross-layer coordination of ETSI DCC, and propose a more compatible design.
6. We propose decentralized resource allocation and congestion control for vehicles with diverse capabilities and applications having heterogeneous channel resource requirement.
7. We demonstrate the challenges of ITS-G5 spectrum sharing with Wi-Fi at the 5.9 GHz band and evaluate the effects on the performance of V2X safety communication.

The applicability of this work is not limited to DSRC/ITS-G5, and the implications are also valid for channel congestion control for LTE V2X Mode 4. Considering that applications and traffic pattern remain the same, congestion control in LTE V2X may also face similar cross-layer coordination issues which have been analyzed with ITS-G5 in this thesis. Consequently, with further work, the contributions of this thesis can be extended to LTE V2X, as discussed in Chapter 5.

1.9 List of Publications

Conference

1. In vehicle resource orchestration for multi-V2X services Khan, Mohammad Irfan; Sesia, Stefania; Härrri, Jérôme VTC 2019 Fall, 90th IEEE Vehicular Technology Conference, 22-25 September 2019, Honolulu, Hawaii, USA
2. Deep learning-aided resource orchestration for vehicular safety communication Irfan Khan, Mohammad; Aubet, François-Xavier; Pahl, Marc-Oliver; Härrri, Jérôme Wireless Days 2019, IEEE/IFIP Days 2019, 11th edition, 24-26 April 2019, Manchester, UK
3. Flexible packet generation control for multi-application V2V communication Khan, Irfan; Härrri, Jérôme VTC 2018-Fall, IEEE 88th Vehicular Technology Conference, 27-30 August 2018, Chicago, USA
4. Integration challenges of facilities-layer DCC for heterogeneous V2X services Khan, Mohammad Irfan; Härrri, Jérôme IV 2018, 29th IEEE Intelligent Vehicles Symposium, 26-29 June 2018, Changshu, Suzhou, China
5. IoT and microservices based testbed for connected car services Datta, Soumya Kanti; Khan, Mohammad Irfan; Codeca, Lara; Denisy, B.; Härrri, Jérôme; Bonnet, Christian SMARTVEHICLES 2018, 5th WOWMOM Workshop on Smart Vehicles: Connectivity Technologies and ITS Applications, colocated with WOWMOM 2018, June 12-15, Chania, Greece
6. Rethinking cooperative awareness for future V2X safety-critical applications Khan, Mohammad Irfan; Hoang, Gia-Minh; Härrri, Jérôme VNC 2017, IEEE Vehicular Networking Conference, November 27-29, 2017, Torino, Italy

7. Can IEEE 802.11p and WI-FI coexist in the 5.9GHz ITS band? Mohammad-Irfan, Khan; Härrri, Jérôme WOWMOM 2017, IEEE WoWMoM SmartVehicle Workshop, 12-15 June 2017, Macau, PR China

Journal/Magazine

1. A taxonomy of Decentralized Congestion Control Protocols and Standards in Europe
Magazine Article Under Preparation
2. Resource Allocation for Muti-V2X services under Channel Congestion
Journal Article Under Preparation

Patent

1. Multi Application Factor based Facility Layer Congestion Control Khan, Mohammad Irfan; Sesia, Stefania; Härrri, Jérôme Patent Holder: Renault SAS
Status: Under Review

Presentations/Posters

1. Facilities DCC for heterogeneous V2X services - Initial evaluation and perspectives Khan, Irfan; Härrri, Jérôme ITS 2018, 9th ETSI ITS Workshop, March 6-8, 2018, Berlin, Germany
2. Coexistence challenges between RLANs and ETSI ITS-G5 at 5.9GHz for future connected vehicles Khan, Irfan; Härrri, Jérôme Workshop on Smart Mobility, June 1-2, 2017, Luxembourg
3. Can ITS-G5 & WI-FI coexist? Mohammad-Irfan, Khan; Härrri, Jérôme BMW-EURECOM-TUM Summer School 2016, July 18-23, 2016, Tegernsee, Bavaria, Germany

1.10 Organization of the thesis

The content of the following chapters has been summarized in this section.

Chapter 2 presents the standardization organizations, and describes the standardized protocols for V2X communication in Europe and USA, along with the standardized approach to channel congestion control. It provides a state of the Art of V2X communication with regards to Medium Access Control, Channel Congestion Control and Spectrum Sharing. The chapter ends with a philosophical discussion on the existing design methodology and its shortcomings.

Chapter 3 Presents the spectrum sharing problem and analyzes protocols for sharing the reserved ITS spectrum with other services at the 5.9 GHz band. Similarly, this chapter groups and illustrates the congestion control and in-vehicle and inter-vehicle resource allocation mechanism standardized by ETSI across almost half a dozen standards. Moreover, the chapter presents and analyzes the different traffic shaping and flow control protocols in the ETSI ITS communication stack, along with application prioritization and quality of service. The issues at different layers, along with lack of coordination and incompatibility between entities at different layers of the stack have also been analyzed in this chapter.

Chapter 4 Provides numerical and simulation based evaluation of the issues discussed in Chapter 3, and suggests improved design and protocols to solve those issues. Moreover, the chapter presents a multi factor prioritization function introducing rank, usefulness and urgency for fine grained resource balancing among V2X services. Similarly it presents a budgetary scheduler based on resource earning/spending supporting a smoother resource allocation over time, and allowing flexible adjustments of the priority between V2X services as a function of their dynamic budget. Additionally, an approach of dencentrally re-allocating channel resource among vehicles with heterogeneous transmit requirements have been proposed and analyzed in this chapter.

Chapter 5 Provides discussion and implications of the results, along with how they can be extended to other use cases and technologies beyond ITS-G5/DSRC, followed by concluding remarks.

Chapter 2

State of the Art

This chapter presents the related work in the domain of channel congestion control and resource orchestration, to set the perspective of what has been done in this field so far. The chapter starts by briefly presenting the standardization organizations in the field of V2X communication followed by an overview of the V2X communication standards and protocols, standardized in Europe and the USA.

Similarly applications, services and messages for initial deployment and future use cases have been presented in this chapter, as the thesis focuses on congestion control and resource orchestration for multi service safety V2X communication. Similarly, the standards on channel congestion control have been described in this chapter, to aid the explanation in subsequent chapters.

In the latter half of this chapter, a literature review of the research activity on channel congestion control and resource orchestration has been provided, along with what have been missing and how the work in this thesis fits on top of that. Lastly, this chapter ends with a philosophical discussion of the issues with the existing bottom up design viewpoint and a justification of the top down design philosophy proposed in this thesis.

2.1 Standardization Organizations

As mentioned in Chapter 1, standardized V2X congestion control protocols use the channel inefficiently and more so if multiple V2X messages are transmitted on the same channel. Therefore, a substantial amount of work in this thesis has been analyzing and proposing improvements to standardized V2X congestion control mechanisms. In this regard, this chapter starts with a brief introduction of the Standardization Organizations (SDO) developing standards for V2X communication.

- **European Telecommunications Standards Institute (ETSI):** Technical Committee (TC) on ITS was founded in 2007 and defines standards on car-to-car and car-to-roadside communication architecture, protocol stack, security, management. ETSI TC ITS also develops standards for C-ITS applications on road safety and traffic efficiency.
- **Car2Car Communication Consortium (C2C-CC):** was founded in 2002, which can be described as a nonprofit, industry driven organization, initiated

by European vehicle manufacturers and supported by equipment manufacturers, research organizations and other partners. It develops industry standards and implementation profile, and carries out testing and deployment of C-ITS in Europe. For example, C2C-CC has extended the channel congestion control standards of ETSI and has specified the actual values of the parameters to be implemented for real deployment. Similarly, C2C-CC released its Basic System Profile (BSP), which has been integrated into the EU Delegated Act [9].

- **3rd Generation Partnership Project (3GPP):** a consortium founded in 1998, which has been responsible for the development and standardization of mobile telephony since the 3rd generation, i.e. 3G UMTS, 4G LTE and 5G. 3GPP entered into the field of V2X standardization in 2016, by publishing V2X specifications in Release 14 of its standards, based on LTE as an alternative to IEEE 802.11 as the underlying technology. It focuses on standardization of 4G LTE and 5G based V2X communication technology.
- **International Standards Organization (ISO):** TC 204 is responsible for the overall system aspects and infrastructure aspects of intelligent transport systems (ITS). It coordinates overall ISO work in the field of ITS, and develops standards in cooperation with other standardization bodies. ISO TC 204 developed a framework called communication access for land mobiles (CALM), integrating all types of existing mobile technologies 3G/4G, WiMax, CEN-DSRC, IEEE 802.11 to provide seamless V2I connectivity.
- **European Committee for Standardization (CEN):** CEN TC 278 is Responsible for preparing and managing ITS standards in Europe, particularly with regards to Traffic Management. CEN cooperates with ISO TC 204 and jointly develops CEN/ISO standards.
- **Institute of Electrical and Electronic Engineers (IEEE):** Develops 802.11 based standards for the Access Layer and 1609.x family of standards for the WAVE protocol stack in the USA, for V2X communication on top of 802.11 Access technology. In the USA, IEEE developed the lower layers of the WAVE protocol stack, while SAE developed the Service and the Application layers.
- **Society for Automotive Engineers (SAE):** Is an organization in the USA, which develops standards for V2X message sets for short and medium-range wireless communication protocols. Notably, SAE developed the J2945 set of standards [37], which defines the V2X messages in the USA. Similarly, SAE developed the channel congestion control mechanism for the WAVE protocol stack in the USA. Moreover, SAE defines other specifications such as V2X application performance requirements, recommended best practices for interoperability etc.

2.2 Standardized Protocol Stack in Europe and USA

2.2.1 Architecture - ETSI TC ITS

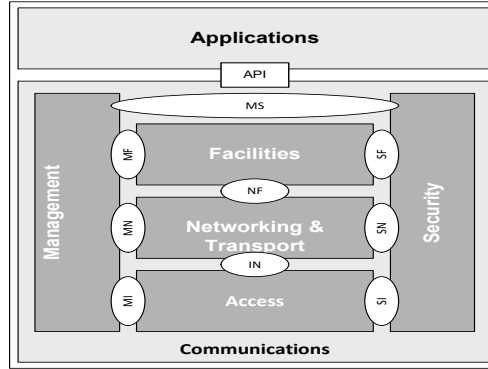

Figure 2.1: ETSI Station Architecture

In Europe the standardization of ITS communication protocol and architecture activities are carried out jointly by several partners such as CEN, Car2Car Communication Consortium (C2C-CC) and ETSI. The first standard for ITS communication protocol stack in Europe was released by ETSI in 2010 and specified in the standard EN 302 665 [38].

Figure 2.1 illustrates the ETSI ITS protocol stack. As shown in the figure, the stack follows the ISO OSI layered approach, containing Access, Network and Transport, Facilities and Application layers. The access technology for physical and medium Access layers is called ITS-G5. The Network and Transport layers can be similar to legacy OSI stack i.e. containing IPv6 and TCP/UDP or a new type of protocol for routing and addressing in ad-hoc vehicular networks called GeoNetworking with Basic Transport Protocol (BTP). The application and the type of communication governs which Network and Transport layer protocols to use. For example IPv6 is used for communicating with ITS stations connected to an IP infrastructure whereas GeoNetworking for ad-hoc communication.

A new layer called Facilities layer has been added to the C-ITS stack between the Transport layer and the Application layers. Similarly, there are two cross layer vertical entities for Management and Security. The functionalities of each layer of the ETSI ITS stack have been elaborated in the following subsections.

2.2.2 Architecture - IEEE 1609.4 WAVE

In the USA, several organizations have contributed to develop the ITS protocol stack, which contains standards from IEEE, SAE and ISO, as shown in Figure 2.2. Similar to ITS-G5, the Access layer is based on IEEE 802.11p standard. A part of the MAC Layer, Network and Transport Layers are defined in IEEE 1609.x family of standards, collectively called as Wireless Access for Vehicular Environment (WAVE). The communication technology is referred to by another name called Dedicated Short Range Communication (DSRC), and the terms DSRC and WAVE are

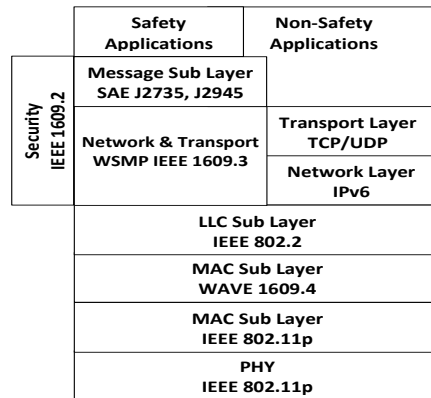

Figure 2.2: WAVE Protocol Stack

often used interchangeably. Nevertheless, the term DSRC has a much wider connotation than WAVE and is used more frequently to refer to the V2X communication based on IEEE 802.11p.

Similarly, the Society of Automotive Engineers (SAE) has developed a set of messages for road traffic safety applications, defined in the message sub-layer standard SAE J2735. From a top-down point of view, the protocol stack from the Application till the Network Layer can be divided into two parts i.e. for Safety and Non-Safety Applications, as explained later.

2.2.3 ETSI Facilities Layer & V2X Safety Messages

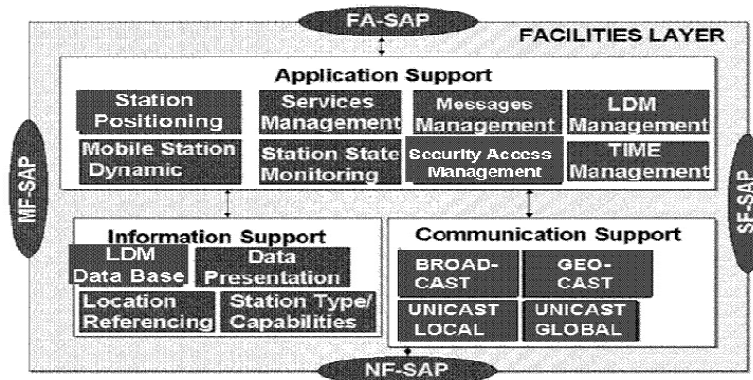

Figure 2.3: Facilities Layer Architecture, Image source [2]

Above the Network and Transport layer is the ETSI Facilities layer [39], which provides support and services to ITS applications, providing analogous functionalities found in the application presentation and session layers of the OSI stack, with amendments dedicated to ITS. As shown in Figure 2.3, the functionality of the Facilities Layer can be classified as: Application support, Information support and Communication support, as described below.

Communication support facility: A facility that provides services for communication and session management, for example selecting addressing mode at the

lower layers, congestion control, session support, mobility management etc.

Application support facility: A facility that provides common services and functionalities for execution of a basic set of applications. Examples of this facility can be: Human Machine Interface support, Time service, Announcing of services etc. An important service of this facility is the management of messages such as Decentralized Environment Notification Message (DENM) and Cooperative Awareness Messages (CAM), which are detailed in Subsection 2.2.3.

Information support: A facility that provides common data and database management functionalities to applications, for example the station type and its capabilities, a map database, Local Dynamic Map (LDM) etc. LDM is a database for storing and managing non-persistent information on the fly. Safety applications on one ITS node do not directly communicate with another safety application on another node. ITS stations exchange information via messages such as CAM and DENM, and these dynamic information are stored in the LDM. Applications in turn retrieve these dynamic information from the LDM. Therefore, services such as Cooperative Awareness or Decentralized Environment Notification manage the exchange of information or messages, and applications interact with those services.

ETSI Facilities Layer is a key aspect for this thesis, as an application resource orchestrator has been proposed in this thesis at the Facilities Layer, which has been detailed in Chapter 4.

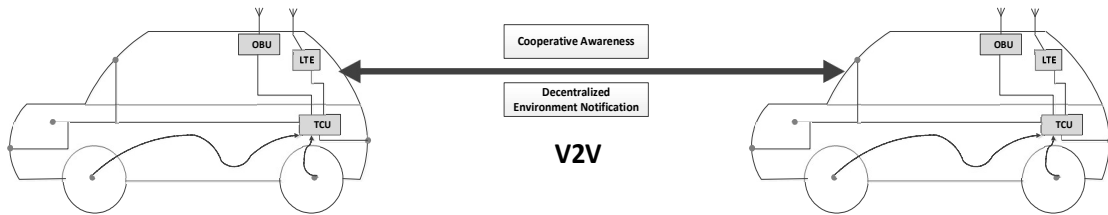

Figure 2.4: V2V Services for Day 1

2.2.3.1 Services and Messages for Initial/Day 1 Deployment

Recently in early 2019, the European Commission proposed a Delegated Regulation [9]¹ specifying 5 V2X messages: CAM, DENM, SPATEM, MAPEM and IVIM, to be available during initial deployment, a.k.a DAY 1 scenario in Europe. Although all these 5 messages can be communicated between vehicles and the infrastructure, but mostly CAMs and occasionally DENMs will be exchanged via V2V communication, as shown in Figure 2.4. The use cases, generation rules and format of these messages and services have been briefly outlines in this subsection.

Cooperative Awareness Message (CAM)

CAMs are periodic messages, generated and managed by the Cooperative Awareness service at the Facilities layer of the nodes, and are broadcast on the Control Channel as SHB using the GeoNetworking protocol. A CAM contains the position, direction, dynamics and basic attributes of the originating ITS node. By receiving CAMs, a vehicle is aware of the presence and attributes of other vehicles in

¹The Delegated Act is yet to pass at the EU parliament at the time of writing.

its neighborhood. Information distributed by CAMs is commonly used by several important safety applications, like Intersection Collision Avoidance, Lane-Change Warning, Approaching Emergency Vehicle or Slow Vehicle Warning. Therefore, CA is a mandatory service at the Facilities layer of a mobile ITS-station.

On the other hand, a CAM from a Road Side Unit (RSU) announces the basic attributes of that RSU. It may announce about other ITS infrastructures on the road, such as CEN DSRC road tolling stations, which allow vehicles to engage the necessary mitigation techniques to avoid interference with CEN DSRC stations.

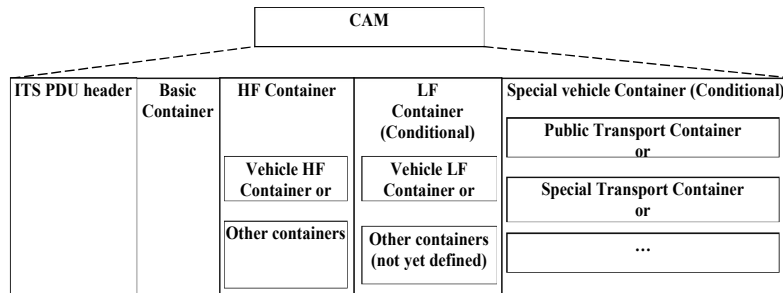

Figure 2.5: Structure of a CAM, image source ETSI EN 302 637-2 [3]

As shown in Figure 2.5, a CAM is constructed as a set of containers. The Header, Basic Container and the High Frequency (HF) containers are mandatory for each CAM. The basic container provides the type of station and the latest position. The HF container contains highly dynamic data such as heading, speed and basic sensor data. The Low Frequency (LF) container is optional and contains slowly changing vehicle data. Lastly, the Special Vehicle Container is only present for vehicles having a special role such as emergency vehicle, roadwork vehicle, public transport etc.

In mobile nodes, CAMs are transmitted at a frequency between 1 and 10 Hz, and are triggered by a change in a node's dynamics, i.e. speed, direction or position. A CAM is triggered whenever there is a:

- 4 degree absolute difference between the current heading and that transmitted in the previous CAM
- 4 m difference between the current position and the position of the previous CAM
- 0.5 m/s difference in the current speed and speed included in the last CAM

In addition to the triggering conditions, the CAM frequency is limited by the level of channel congestion between 1 to 10 Hz, as determined by the channel congestion control mechanism as specified in EN 302 637-2 [3]. For static ITS nodes such as RSU, the default CAM transmission frequency is 1 Hz, which may be adjusted depending on the application needs.

Decentralized Environment Notification Message (DENM)

DENM (ETSI EN— 302 637-3)is high priority message emitted by an application during a traffic emergency, upon the detection of a hazardous event or abnormal traffic condition. The goal of a DENM is to alert other road users about an event or emergency condition with a potential impact on road safety. Unlike CAMs, DENMs are not triggered by time but are triggered following the detection of an

event. DENMs are used by applications like Cooperative Road Hazard Warning (C-RHW) or Electronic Emergency Brake Light Warning (EEBL). As shown in Figure 2.6, a vehicle suddenly brakes, which immediately triggers a DENM, alerting vehicles behind and decreasing the probability of a rear end collision.

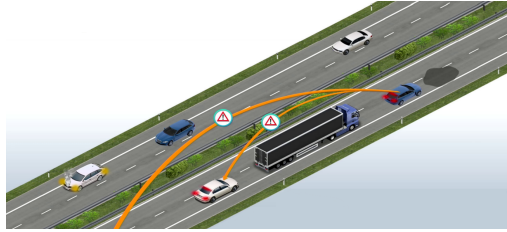

Figure 2.6: Electronic Emergency Brake Light Warning

Upon detection of an event such as RHW, vehicles immediately geo-broadcast a DENM to all vehicles located inside a relevant area. An event is characterized by an event type, a geographical position/area, the detection time and duration. The DENM transmission is repeated with a certain frequency and certain range depending on the event, and persists as long as the event is present. Normal DENM for a use case like Road Work Warning, can be transmitted with a frequency of up to 10 Hz, and high priority DENM for a use case such as EEBL must be transmitted at up to 20 Hz. A DENM can be forwarded across multiple hops using GeoNetworking, if the destination area is beyond a single hop range.

Signal Phase and Timing Message (SPATEM) & Map Message (MAPEM)

SPATEM is an I2V messages, broadcast by a RSU connected to a traffic light control system and located near an intersection containing real-time traffic light phase and timing information. MAPEM is a similar I2V message, broadcast by a RSU containing geographic road information such as intersection description, lane geometry, road segment geometry, high speed curve outlines etc. SPATEM and MAPEM are typically used in conjunction with each other, a common example of which is the Green Light Optimal Speed Advisory (GLOSA) application. The SPATEM communicates the real-time status of one or more signalized intersection, while MAPEM contains the geometric layout of those intersections. By combining these messages, the GLOSA application can recommend the optimum speed to pass the next traffic signal during its green phase. The European versions of SPATEM and MAPEM have been standardized by ETSI and defined in ETSI TS 103 301 [40].

In-Vehicle Information Message (IVIM) IVIM is a I2V message, broadcast by a RSU to provide static and dynamic road side sign information to mobile ITS stations. Static road signs contain similar information as conventional roadside signposts such as speed limit, while dynamic road signs contain variable information such as Variable Message Sign (VMS), anomalous road condition, traffic condition etc. The goal of IVIM is to notify the receiving vehicle of any relevant safety or traffic efficiency information. The validity of the information depends on the duration, relevance area and characteristics of the receiving vehicle and the transmission is stopped when the validity of the content expires. The IVIM message format and transmission rules are defined in ETSI TS 103 301 [40].

2.2.3.2 Services and Messages for future/Day 2 Deployment

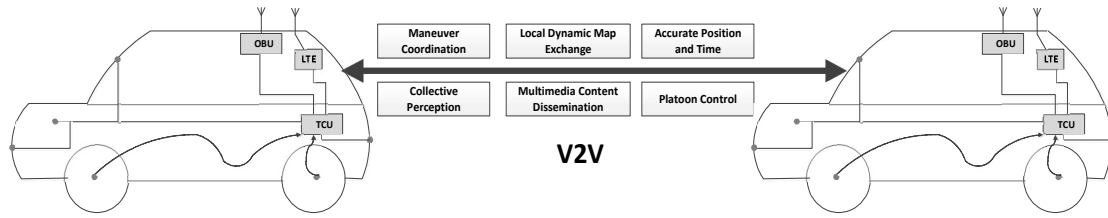

Figure 2.7: Heterogeneous V2V Services for Day 2

The messages discussed in the last subsection would suffice for applications and use cases during initial a.k.a ‘DAY 1’ deployment, but in future V2X, a.k.a ‘DAY 2’ communication scenarios, there will be more sensors, capabilities and applications per node such as HAD, platooning, VRU detection etc., which will generate a variety of new messages, as shown in Fig 2.7. As mentioned in Chapter 1, V2X communication will be used for realizing a concept called ‘extended horizon’, where vehicles will need to gather information outside the range of their own sensors. The conjunction of the various V2X communication, services and messages are critical for creating the ‘extended horizon’ and allow future automated vehicles to take optimal control decisions.

Collective Perception Message (CPM)

One such service currently being standardized is called Collective Perception, ETSI TS 103 324 [28], for vehicles to propagate knowledge of detected objects to neighbors who could potentially benefit from the discovery. CPM is to be transmitted by vehicles and RSUs having sensors to detect objects or non-connected road users, pedestrians, cyclists, obstacles etc. To ensure interoperability among vendors, CPMs communicate abstract representation of detected objects, instead of proprietary raw-sensor data. The object knowledge may be derived from a single sensor or via a fusion of multiple sensors, depending on the implementation.

At the time of writing, the CPM transmission rules are still being drafted, but similar to CAMs, CPMs are to be regularly transmitted via Single Hop Broadcast between 1 to 10 Hz, by a CPM capable ITS node. The channel for CPM transmission is yet to be finalized in the standards, which could be the Control or a Service Channel. A CPM is triggered upon detection of a new object or if the absolute position of a previously detected objects changes by 4 meter, or its heading changes by 4 degrees or its speed by 0.5m/s. In the absence of any object detection, a CPM enabled node transmits CPM at the minimum frequency of 1 Hz, to inform neighbors about its CPM transmission capacity. Lastly, similar to CAMs, in addition to the message triggering conditions, CPM transmission frequency is limited by the channel load, to respect the maximum transmit rate for the node, determined by the Decentralized Congestion Control (DCC) mechanism. DCC has been explained later in Section 2.4.1 of this chapter.

Maneuver Coordination Message (MCM)

Further down the road, communication capabilities will be used for cooperative driving and navigation and further messages will be developed to exchange a vehi-

cle’s ‘trajectory intent’, when vehicles will negotiate and coordinate their very next actions via the exchange of ‘intent’ messages. One such message, Maneuver Coordination Message, which is currently at an early phase of standardization at ETSI TS 103 561. Figure 2.8 shows a use case using MCM, where a vehicle merging into a lane negotiates and coordinates its merging with maneuver with existing vehicles in the lane.

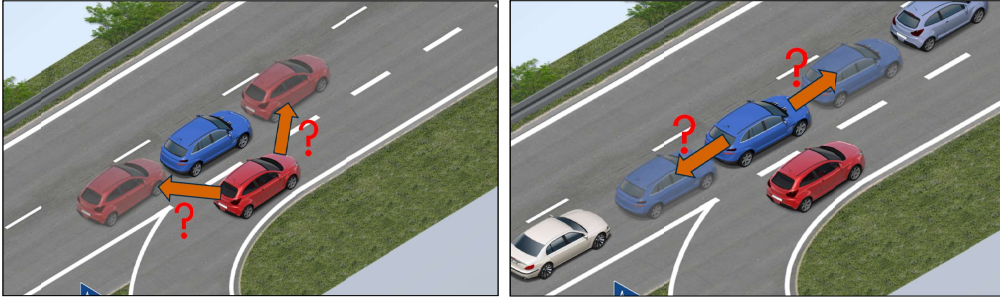

Figure 2.8: Maneuver Coordination, image source [4]

Multimedia Content Dissemination Message (MCDM) MCDM is a message for exchanging multimedia content such as pictures, video clips, audio and data is currently being drafted at ETSI as TS 103 152. Multimedia Content Dissemination (MCD) is a Facilities layer service to support the sharing of multimedia content describing events for safety, traffic efficiency and infotainment applications. Example uses cases can be a safety application sharing videos or pictures of road hazards, or a traffic management application disseminating pictures or videos of current traffic situation.

Similarly, several research projects have proposed messages for future use cases such as platooning, CACC, HAD etc. On the other hand, the number of channels exclusive for V2X communication, in particular for ITS-G5 communication will be limited, as discussed earlier. Therefore in future, there is a high likelihood that multiple safety messages will be broadcast on the same channel, requiring transmit rate control and transmit opportunity allocation for multiple safety messages, which has been addressed in this thesis.

2.2.4 SAE Message Sub Layer & Standardized messages in the USA

On top of the Network and Transport Layers is the Application Layer which runs applications and provides message composition service to the applications using a Message Sub Layer. In the USA, IEEE has developed the the 1609.x family of standards for the lower layers of the protocol stack, while on top of those SAE has developed the Service and the Application layers, as mentioned in Section 2.1. SAE has standardized a Message Set dictionary in the Standard J2735 [41], containing 15 messages as shown in Table 2.1.

SAE J2735 defines around 150 data elements, grouped into data frames, which are used to construct these 15 messages. Out of these messages, the most important

Table 2.1: V2X Messages in the USA, standardized by SAE

1. A La Carte (ACM)	8. Probe Data Management (PDM)
2. Basic Safety Message (BSM)	9. Probe Vehicle Data (PVD)
3. Common Safety Request (CSR)	10. Road Side Alert (RSA)
4. Emergency Vehicle Alert (EVA)	11. RTCM Corrections (RTCM)
5. Intersection Collision Avoidance (ICA)	12. Signal Phase and Timing (SPAT)
6. MAP	13. Signal Request Message (SRM)
7. NMEA (GPS) Corrections (NMEA)	14. Signal Status Message (SSM)
	15. Traveler Information Message (TIM)

message is the BSM, which is transmitted periodically via Single Hop Broadcast, communicating to the neighbors a node’s basic status and kinematic information, such as GPS position (latitude, longitude, altitude), motion, acceleration, heading angle, steering wheel angle, brake system status, vehicle type etc. in order to develop cooperative awareness and support V2X safety applications.

The information content of BSM has two parts, part I and II. Part I is mandatory in every BSM, containing data elements pertaining to critical state information of the vehicle, such as the elements mentioned above. Part II is optional consisting of additional data elements containing emergency event flags, such as Hazard lights, Hard braking, Flat Tyre or other less frequent information such as Path History, Path Prediction etc.

According to [42], the average size of a BSM is around 320 bytes. The Physical, MAC and WSPM header and trailers make up 80 bytes. The BSM payload itself is around 80 bytes. Lastly, security including full certificate makes up 160 bytes giving a total of 320 bytes. The maximum BSM transmit rate is 10 Hz, but can be reduced to mitigate channel congestion, if the channel load is too high, using the SAE Congestion Control Algorithm (CCA), as described in Section 2.4.2.

2.2.5 ETSI Network & Transport Layer

At Layer 3, ETSI specifies an ad-hoc, connectionless, packet switched routing protocol called GeoNetworking, which uses 2D geographic location (latitude, longitude) for addressing and forwarding. Packets can be disseminated using one of the three “geo” mechanisms: geo-unicast, geo-broadcast and geo-anycast. Geo-unicast is targeted to a single recipient at a location, whereas geo-broadcast is targeted to all the recipients inside a particular geographic area or geometric shape (circle, ellipse) and geo-anycast is targeted to at least one recipient within a target area/shape.

If the recipient or the target area is outside the range of a single hop transmission, then a packet can be forwarded using a sender-based greedy forwarding or a contention-based forwarding at the receiver. With simple geo-broadcast, the source floods to all single-hop neighbors who may re-broadcast the packet a single time, if the next or destination hop is located within the relevant area and if a duplicate re-broadcast is not detected (identified using source id and packet sequence number).

GeoNetworking also supports two other dissemination modes which do not use geographic addressing i.e. single-hop broadcast and topologically scoped broadcast. Single-hop broadcast is dissemination to all nodes within one hop distance and the recipients do not re-forward the packet. For example, transmission of CAM is done by single hop broadcast. Lastly, Topological broadcast targets all nodes that are at a distance of N-hops.

ETSI networking and transport layer standards consist of several sub-parts belonging to the series EN 302 636. Part 1 of the standard outlines requirements, part 2 describes scenarios, and part 3 specifies networking architecture.

The Layer 3 protocol is defined in part 4, which in turn consists of two parts, i.e. part 1 media-independent and part 2 media-dependent functionalities. The first part is specified in TS 102 636-4-1, [43] outlines the packet format and protocol for packet handling for the broadcast/forwarding scenarios mentioned above. An important aspect of GeoNetworking part 1 is to support traffic classification at the Network Layer, by which a GeoNetworking packet is placed into a limited number of priorities or Traffic Classes (TC) to execute the Quality of Service (QoS) requirement for the packet transport, set by the Facilities Layer above it. GeoNetworking part 2 in turn maps the TC into Layer 2 Access Categories, such as Voice, Video, Best Effort and Background if the access technology is ITS-G5. TC and QoS are important aspects in this thesis and have been detailed in Section 3.4.1.

The second part, is defined in TS 102 636-4-2 [31] specifies the role of the network layer for DCC functionality specific to ITS-G5 Access technology. GeoNetworking allows a packet to carry a payload of 1398 bytes and it is also possible to send IPv6 packets over GeoNetworking protocol, as specified in TS 102-636-6 [44].

The Layer 4 protocol, i.e. Basic Transport Protocol (BTP) is defined in part 5, in the standard TS 102-636-5 [45]. BTP is an end-to-end, connectionless transport layer protocol whose role is to multiplex messages from different services at the Facilities Layer at the sender and demultiplex those at the receiver, using source and destination port numbers as done by TCP/UDP. It has been designed by ETSI to be lightweight, just adding a 4-byte header to the packet coming from the Facilities Layer above it.

2.2.6 IEEE Wave Network & Transport Layer

The Network and Transport Layers have a single protocol in the IEEE WAVE stack, called WSMP and are defined in the standard IEEE 1609.3. WSMP is tailor made for quick and efficient transmission of lightweight single-hop messages, referred to as WAVE Short Message (WSM). Compared to traditional Layer 3 IPv6, which adds an overhead of at least 52 bytes for a UDP/IPv6 packet, WSM overhead is only between 5 to 20 bytes. A typical example of WSM is the Basic Safety Message (BSM), a safety message used for periodic broadcast of position, motion and the basic status of a vehicle and information during traffic emergencies.

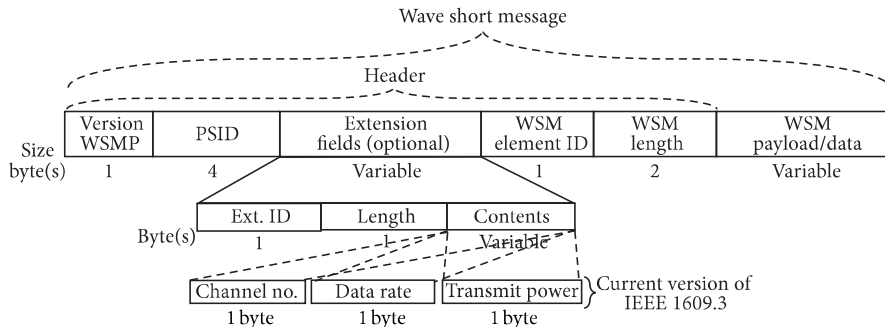

Figure 2.9: Wave Short Message Format (Image via Creative Commons)

The WSM format is shown in Figure 2.9, which contains 3 extension: channel number, data rate and transmit power. These parameters enable an application to define the transmission requirements of the message. Additionally the header contains a protocol version, header length, element ID and the payload such as BSM.

The WSMP also performs a management plane function called Wave Service Advertisement (WSA). A WSA is a management frame, sent on the CCH to advertise the services found on the different SCHs. Similarly it indicates whether the WSA is provided using IPv6 or WSMP. A service is an information or utility for the vehicle and/or its occupants, such as traffic alerts, toll information navigation, internet access etc. The Provider Service Identification (PSID) is a unique ID used by a service provider to advertise the service. Similarly, WSMP uses the PSID to deliver the WSM content to the higher layer based on the PSID value set by the WSM sender.

Single-hop messages, like BSM used for traffic safety use WSM whereas applications requiring multi-hop forwarding use TCP/UDP at the Transport Layer using the addressing and routing provided by IPv6 at the network Layer. It is up to the application to choose the network and transport layer protocols based on its requirements.

2.2.7 ETSI Access layer

The Access layer in the ETSI-ITS architecture is composed of the physical and data link layers. It implements the IEEE 802.11p MAC and PHY layer standards, which have been derived from IEEE 802.11a, with few changes for operation in the dynamic environment of vehicular networks. The work on IEEE 802.11p started in 2004 and was finalized in 2010, as "Amendment 6: Wireless Access in Vehicular Environment" to IEEE 802.11. It was included in the standard IEEE 802.11-2012.

2.2.7.1 Physical Layer

The Physical Layer of 802.11p uses Orthogonal Frequency Division Multiplexing (OFDM), which basically divides the frequency band into narrower sub-carriers, with each sub-carrier orthogonal to each other. There are 52 sub-carriers out of which 48 are used to carry modulated data and 4 are pilot sub-carriers. OFDM supports channels of 5, 10 and 20 MHz wide. Although Access point based IEEE 802.11 channels are 20 MHz for 802.11a or wider for 802.11n, ac (via channel bonding), but for vehicular communication, 802.11p channels are 10 MHz wide. Keeping the number of sub-carriers fixed, narrower channels mean the sub-carrier spacing is reduced while the time domain parameters such as symbol duration and guard interval are increased, which protects against inter symbol interference caused by multi-path propagation. Thus, 10 MHz channels give an OFDM symbol duration of 8 μ s including guard interval, with a sub-carrier frequency spacing of 0.15625 MHz.

To transmit data in each sub-carrier, IEEE 802.11p uses a digital modulation technique, such as Binary Phase Shift Keying (BPSK), Quadrature Phase Shift Keying (QPSK), 16 Quadrature Amplitude Modulation (QAM), or 64 QAM. Additionally, IEEE 802.11p uses Forward Error Correction (FEC) to increase the probability of detecting and correcting erroneous bits and decode the data successfully. This increases the message robustness but adds redundancy to the message, so the

Table 2.2: Data Rates supported by IEEE 802.11p

Data Rate [Mbps]	Modulation	Coding Rate	Data Bits Per Symbol Per Subcarrier	Data Bits Per Symbol (48 sub-carriers)
3	BPSK	1/2	0.5	24
4.5	BPSK	3/4	0.75	36
6	QPSK	1/2	1	48
9	QPSK	3/4	1.5	72
12	16-QAM	1/2	2	96
18	16-QAM	3/4	3	144
24	64-QAM	2/3	4	192
27	64-QAM	3/4	4.5	216

trade-off is the reduction of the actual data rate. Thus, the data rate is determined by two factors, i.e. the type of modulation used and the coding rate of the FEC, giving a data rate from 3 to 27 Mbps as shown in Table 2.2. The default data rate is 6 Mbps, which has been proven to be the optimal choice for safety communications, as stated in [46]. Regarding transmit power, the maximum power is limited to 23 dBm/MHz for CCH and SCH1, and 13 dBm/MHz for SCH2 and SCH3, to limit the out of band interference.

2.2.7.2 Data Link Layer

In vehicular networks, nodes are highly dynamic and stations quickly appear and disappear outside the radio range of each other, which requires rapid communication. Therefore, unlike infrastructure based Wi-Fi networks, 802.11p does not require setting up a basic service set (BSS), avoiding delay required for control and management steps, such as channel scanning, authentication, and association. It applies an ad-hoc mode, called outside the context of a BSS (OCB) mode enabling a flag called *dot11OCBActivated*. Without using control messages, nodes can directly start communicating with each other, using only the minimum components required for a 802.11 network. Lastly, the duration of a slot in IEEE 802.11p standard is 13 μ s, unlike 9 or 20 μ s of other 802.11 standards.

2.2.7.2.1 Medium Access Control Regarding Medium Access Control (MAC), ITS-G5 uses the same mechanism of legacy IEEE 802.11, allocating a stochastic channel access opportunity via Carrier Sense Multiple Access with collision avoidance (CSMA/CA). Before each transmission a node senses the energy in the channel for a fixed duration called Arbitration inter-frame spacing (AIFS). If the energy is below the Carrier Sense threshold, for example -92dBm, the channel is considered free, and the node transmits. If the channel is found busy, then the node backs-off during a random contention window, between a maximum CW_{max} and minimum CW_{min} , decreasing the back-off counter every-time the channel is free and transmitting when the back-off counter reaches 0.

Each station has a single MAC entity for each channel, and QoS is provided via Enhanced Distributed Channel Access (EDCA), derived from IEEE 802.11e standard. EDCA defines 4 priorities, known as Access Categories (AC) to provide prioritized channel access to one application or service over another. An AC of higher priority has lower AIFS, CW_{min} and CW_{max} , ensuring lower waiting time and faster channel access.

Additionally ITS-G5 Access layer has been designed to provide two other functionalities known as Decentralized Congestion Control (DCC) and Multi Channel Operation (MCO). DCC limits the spatial and temporal channel usage of a node to limit the channel load below saturation and has been detailed in Section 2.4.1. MCO can be employed by a node with multiple transceivers, where one transceiver is fixed to a control channel and the other transceiver switches among the service channels. However, MCO standardization is still a Work in Progress at ETSI, and to the best of our knowledge, no standard has yet been published by ETSI regarding MCO.

2.2.7.2.2 Logical Link Control The Logical Link Control (LLC), defined by the IEEE 802.2 standard, is a functionality which serves as an adaptation layer between the Network and the Data Link Layers. To the Network layer, it provides a uniform interface, offering 3 types of services: Unacknowledged connectionless service (Type 1), Acknowledged connectionless service (Type 2), and Connection oriented service (Type 3). GeoNetworking uses Type 1 Unacknowledged connectionless service. Conversely, LLC uses Subnetwork Access Protocol (SNAP) to identify the protocol used at the Network layer, to multiplex various network layer protocols above the Access layer. It uses a 2-byte field called Ethertype, for example GeoNetworking is identified using an Ethertype value of 0x8947 while IPv6 using a value 0x86DD.

2.2.8 IEEE Wave Access layer

Similar to ITS-G5, the Physical layer and the Medium Access sub-layer is based on IEEE 802.11p standards, which uses OFDM at the PHY layer and CSMA/CA at the MAC layer, with specific modifications for the dynamic context of V2X communication, as explained earlier. Therefore, the PHY and MAC layers are not elaborated here for the sake of avoiding redundancy.

Unlike ITS-G5, in the WAVE protocol stack there is MAC sub-layer defined in the standard IEEE 1609.4, which specifies the usage of the control and the service channels, and switching between the channels. Whereas, for ITS-G5, the usage of the channels is specified along with the channel congestion control, i.e. DCC specifications.

Similarly, the LLC sub-layer uses the IEEE 802.2 standard, as done by ITS-G5. However instead of GeoNetworking at Layer 3, the protocol used in this stack is called WAVE Short Message Protocol (WSMP), which is identified by the Ether-Type value 0x88DC by the SNAP used to identify the network layer protocol by the LLC sub-layer.

2.2.9 3GPP LTE V2X

An alternative to DSRC/ITS-G5 is 3GPP LTE V2X, which involves Listen Before Talk (LBT) medium access, which has been officially standardized in LTE release 14 in 2016, for safety-critical V2X communication. LTE V2X uses a new sidelink interface called PC5, which uses Single-Carrier Frequency-Division Multiple Access (SC-FDMA) similar to LTE uplink waveform.

LTE-V2X supports two modes of operation, i.e. infrastructure-based (Mode 3) and ad-hoc (Mode 4) channel access and resource allocation. In both the modes, the data plane communication uses the sidelink interface. However, Mode 3 of LTE V2X is designed to be used when vehicles are within the coverage of the cellular network, where the control plane is managed by the eNodeB, which orchestrates medium access by allocating and reserving radio resources for each node. Similarly, Mode 4 has been designed to function without the eNodeB, where each node individually selects radio resources via Carrier Sensing using LBT similar to CSMA.

However, unlike CSMA the radio resources in each channel are divided into the time and frequency domains. The time domain is divided into subframes of 1ms duration, requiring all the nodes to have the same time reference. In the frequency domain, the unit of division is called a resource block (RB), which is 180 kHz wide in frequency. The grouping of a variable number of RBs inside a subframe is called a subchannel.

In Mode 4, a node listens and analyzes the last 1000ms and selects the resources having the lowest historical Received Signal Strength Indicator (RSSI), while in Mode 3 the eNodeB allocates the resources. In both the modes, to avoid frequent resource reselection, the selected/allocated resources can be reserved via SPS for several future transmissions, randomly chosen between 5 to 15 using a reselection counter. After using those resources, the node can reserve a new set of resources, or reuse the same ones with a certain probability.

LTE V2X has not been further detailed in this thesis, and the reader can refer to [47, 48] for more details.

2.2.10 Cross Layer Entities

In addition to the horizontal layers, there are also vertical or cross layer entities in the C-ITS stack for management and security. The management entity manages cross-layer functionalities such as Decentralized Congestion Control (DCC) (described in Section 2.4.1) and Communication Profiles, specifying the type of communication interface selected based on the application's requirements, access technology characteristics, network conditions etc. The security entity provides support for asymmetric cryptography, and authentication and encryptions of messages at each layer. This entity performs cryptographic operations such as encryption and hashing. It also manages items such as keys and certificates for PKI and pseudonyms for privacy.

2.3 Channel Coexistence

2.3.0.1 Coexistence between ITS-G5/DSRC & WiFi

Since 2015-16, spectrum regulators have initiated a discussion on the potential coexistence of future WiFi and IEEE 802.11p technologies [49]. Regulators decided to allow Wi-Fi to use the ITS bands, under the strict condition that IEEE 802.11p remains the primary user and Wi-Fi should not cause harmful interference on IEEE 802.11p.

The necessity for coexistence in the 5GHz band is directly related to the scarce capacity left in this band. As illustrated in Fig. 2.10, on the lower part the 5GHz

band is composed of multiple 20MHz WiFi channels, while on the upper part there are seven 10MHz IEEE 802.11p channels. With IEEE 802.11ac required support for 80MHz and 160MHz channels, a channelization extension has been proposed to have multiple 80MHz and 160MHz channels ranging from 5.4GHz up to 5.9GHz. Accordingly, the 70MHz ITS band will no longer be reserved for seven 10MHz channels, but will also include two 20MHz, or one 40MHz, or a part of 80MHz and 160MHz channels. WiFi not being capable of operating on 10MHz, IEEE 802.11p will need to share its spectrum with WiFi operating on larger bands.

Thereby, two spectrum sharing protocols called Detect and Mitigate and Detect and Vacate have been considered for standardization at ETSI, as outlined in the standard TR 103 319 [49], which are briefly presented below. For both these protocols, WiFi must have a 10MHz ITS-G5 detector per ITS channel, without any modification to ITS-G5 i.e. as WiFi operates on channels 20MHz or wider, ITS-G5 cannot decode WiFi preamble and does not take any active part in these protocols.

2.3.0.1.1 Detect and Mitigate

The basic principle of DAM is that once ITS-G5 is detected, WiFi uses higher EDCA parameters, and waits longer than ITS-G5 traffic of the same EDCA class before transmitting. Figure 2.11 demonstrates the behavior of this protocol as a state machine, as we interpreted it from the standard. It starts with a CCA by WiFi. If a WiFi device does not detect ITS-G5 signal, it can fully use the ITS-G5 channels using regular IEEE 802.11ac/n backoff parameters. If WiFi detects ITS-G5 traffic, it activates an extended EDCA mode by increasing the parameters of its own EDCA queues with higher backoff values (obligatory AIFS + random backoff), compared to ITS-G5, for at least 2s, and continues further if ITS-G5 is detected again during those 2 seconds.

There are two versions of DAM i.e. **Reduced** and **Absolute DAM**, and Table I shows both backoff values.

- **Reduced DAM**, ensures that WiFi performs an obligatory CCA via AIFS and random CW, for a period at least longer than the **AIFS+CW_{min}** of ITS-G5 traffic of the same EDCA class. For example, for class AC_VI, ITS-G5 AIFS+CW_{min} is 3+7=10 slots, while in Reduced DAM mode, WiFi AIFS itself is 21 slots. The goal is to enforce a waiting time on WiFi longer than ITS-G5 CW_{min}, during channel contention and prioritize ITS-G5 packets.
- **Absolute DAM** prioritizes ITS-G5 even more. For each traffic class, it gives WiFi an AIFS longer than the **AIFS+CW_{max}** of ITS-G5 traffic of that

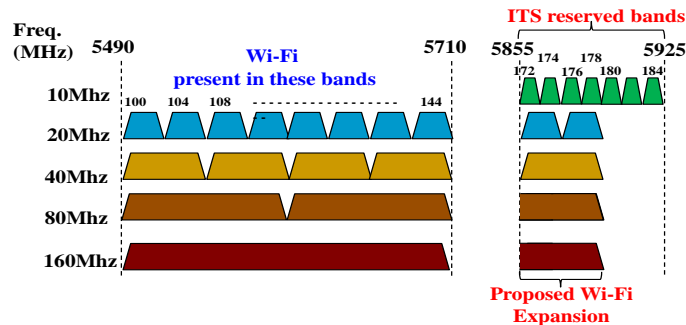

Figure 2.10: WiFi & ITS Spectrum Sharing in 5.7 - 5.9GHz band

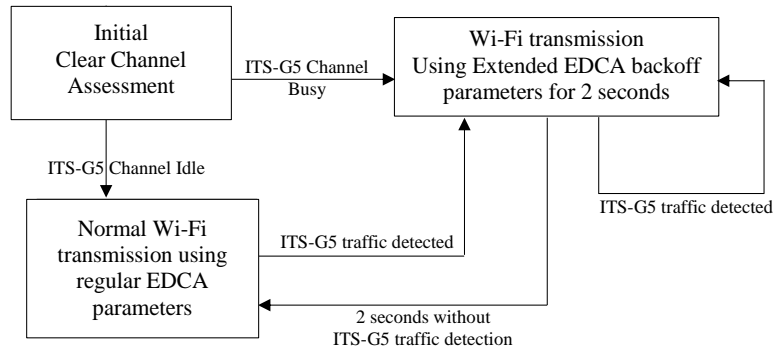

Figure 2.11: Detect and Mitigate State Machine

class. For example class AC_VI of WiFi Absolute DAM mode has an AIFS of $3x2+CW_{max} = 1029$ slots. This is to ensure that a WiFi node absolutely waits longer than ITS-G5, regardless of the ITS-G5 random backoff value between 0 & CW_{max} , which could be useful to prioritize unicast ITS-G5 packets with backoff $> CW_{min}$ during retransmission.

Table 2.3: Detect and Mitigate EDCA parameters

AC	CW min	CW max	AIFSN (Reduced)	AIFSN (Abs)	TXOP Limit (Reduced)	TXOP Limit (Abs)
BK	31	2047	49	2065	2528 ms	2258 ms
BE	31	2047	43	2059	2528 ms	2258 ms
VI	15	31	21	1029	3000 ms	3008 ms
VO	7	15	11	515	2080 ms	1504 ms

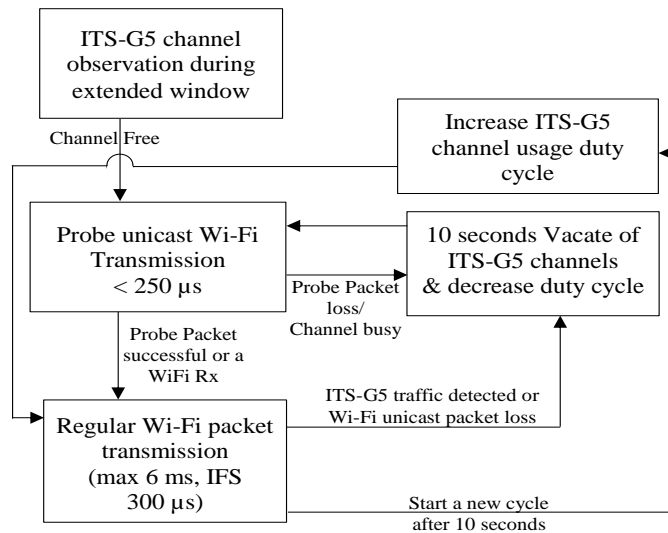

Figure 2.12: Detect and Vacate State Machine

2.3.0.1.2 Detect and Vacate

DAV protocol takes a more cautious approach when using the ITS channels by using longer initial observation period and probe packets. Figure 2.12 presents a

simplified version of this protocol as a state machine, according to our interpretation of the standard ETSI TR 103 319 [49]. In order to transmit WiFi traffic, DAV requires to pass through the following states:

1. **Initial Extended Channel Observation** – the WiFi device senses ITS channels during an extended period, which could be as high as 30 minutes.
2. **Short Packet Probe** – If the ITS-G5 channel is idle during initial observation, it is probed for hidden ITS stations by a unicast short packet of $< 250\mu\text{sec}$.
3. **WiFi Packet transmission** – If the probe packet is acknowledged, WiFi uses ITS channels, limiting transmissions to $< 6\text{ms}$ followed by a $300\mu\text{sec}$ AIFS.

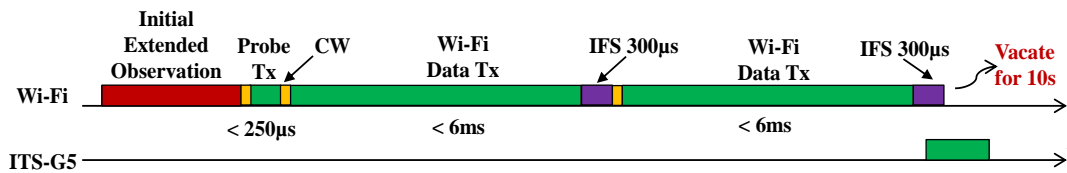

Figure 2.13: Detect and Vacate phases of CCA and transmission

Figure 2.13 shows an example of the different phases of DAV protocol. At any state, if an ITS-G5 transmission is detected or a WiFi unicast packet is unacknowledged, the WiFi device vacates the ITS channels for 10s. Moreover, each 10 seconds channel usage is considered as a cycle and a new cycle is started by updating the WiFi duty cycle limit of ITS channel usage i.e. the limit is increased if no ITS-G5 is detected in the last cycle.

These protocols have been analyzed and evaluated in Chapters 3 and 4 of this thesis.

2.4 Channel Congestion Control

As mentioned earlier, IEEE 802.11p performs medium access control via CSMA/CA. In CSMA based medium access, for unicast communication, when a packet is not acknowledged, the CW is enlarged, commonly known as binary exponential back-off (BEB). An un-acknowledged packet can be due to a collision, and as the channel load increases, so does the probability of collision. Thus, BEB helps to reduce channel congestion by distributing the transmission attempts over longer period, which decreases the probability of simultaneous transmissions and collisions.

However, for broadcast communication BEB is not possible, one of the reasons being that simultaneous acknowledgments transmitted from multiple recipients may collide at the sender. Similarly, a broadcast sender may not be aware of the number of receivers, therefore may not be able to keep track of whether all the receivers have acknowledged or not, so broadcast transmissions are not acknowledged.

As most of the safety related V2X messages such as CAM, DENM, BSM etc. are broadcast, reducing channel congestion via BEB is not possible. To counter this problem, additional mechanisms have been designed on top of CSMA Medium Access, to limit the spatial and temporal channel resource usage by each node and

maintain the overall channel load below saturation. This mechanism is commonly referred to as Decentralized Congestion Control or DCC in European standards and SAE Congestion Control Algorithm (CCA) in American standards. There are several mechanisms for controlling the channel congestion, such as:

- **Transmit Power Control:** limiting the transmit power and reducing the signal propagation range, in order to share the channel with a fewer number of nearby neighbors, and reduce the channel load for farther away neighbors
- **Transmit Data-rate Control:** increase the modulation and decrease the air-time, so that a packet occupies the channel for a lesser duration
- **Carrier Sense Sensitivity Control:** adapting the clear channel assessment threshold, to vary the number of neighbors a node should contend for channel access, i.e. for a lower CCA threshold, a node will be able to detect transmissions from farther away neighbors and calculate a higher channel load
- **Transmit Rate Control:** limiting the transmit rate or a node's 'duty cycle' per unit time, i.e. if the channel load is high a node will transmit less and vice versa. Transmit Rate Control (TRC) has been the principal mechanism of rate control in European standards, and has been addressed in detail in this thesis.

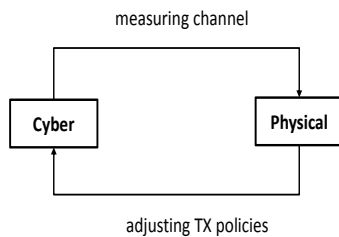

Figure 2.14: DCC as Cyber-Physical System

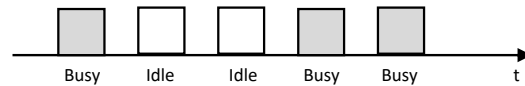

Figure 2.15: Channel Busy Ratio

Conceptually speaking, DCC may be seen as a Cyber-Physical System (CPS), as shown on Fig 2.14, where transmit decisions are optimized based on a feedback control loop from measured channel conditions. The physical block in each node continuously senses the Channel Load (CL), typically using a metric called Channel Busy Ratio (CBR). The CBR is measured as the number of slots occupied during an observation window. For example in Figure 2.15, 3 slots are busy out of 5, giving a CBR of 60%. Based on the sensing metric from the physical block, the control algorithm in the cyber block adjusts its control parameters, mentioned above, influencing the metrics from the physical block.

Although any of the four transmit parameters mentioned above could be used by the cyber layer, the transmit power control as a function of the channel load is used in the American standard as the primary mechanism, while the transmit rate is limited based on the neighbor density. Similarly, in the revised European standard the transmit rate control is used as the sole mechanism at the cyber layer. The performance implications are that decreasing the transmit rate impacts

the precision of the positioning information, while decreasing the transmit power impacts the number of neighbors receiving the transmission.

For the stability of the CPS control loop, a single sensing metric from the physical layer should influence only a single cyber layer control parameter, i.e. transmit rate or power control. However both should not be controlled simultaneously using a single sensing metric such as channel load. The initial ETSI DCC standard released in 2011 [10], specified mechanisms to control the 4 parameters as a function of the channel load. Several research studies [33, 50], have found the initial ETSI DCC to be ineffective, and even performing worse than without any DCC.

2.4.1 ETSI Decentralized Congestion Control Standards

In ETSI standards, the Transmit Rate Control as a function of the channel load is the sole mechanism used for congestion control, as mentioned above. However, from an implementation point of view, the mechanism is spread across several layers of the ETSI ITS stack and is in fact a cross-layer mechanism, with functionalities at the Access layer, Network layer, Facilities layer and the vertical management plane. ETSI has specified a separate standard for each DCC functionality, as shown in Table 2.4. Similarly, specifications from Car2Car Communication Consortium provide implementation profile with implementable values of the parameters given in the ETSI standards, as ETSI ITS standards usually specify the limits, but not values to be implemented in the system.

Table 2.4: DCC Standards in Europe

DCC Specifications in Europe	Standard	Version	Key Feature
DCC Access	ETSI TS 102 687	V1.2.1 (2018-04)	Transmit Rate Control at the Access layer
DCC Network and Transport	ETSI TS 102 636 -4-2	V1.1.1 (2013-10)	Conveys locally measured and piggybacks highest received CBR among neighboring nodes
DCC Facilities	ETSI TS 103 141	V 0.0.9 (2017-10) DRAFT	Distributes a node's Channel Usage Limit among applications & services
DCC Management	ETSI TS 103 175	V1.1.1 (2015-06)	Communicates information across layers for DCC functionality at different layers
Harmonized Channel Specifications (ETSI DCC Profile)	ETSI TS 102 724	V1.1.1 (2012-10)	Specifies Transmit Rate Limit for ETSI DCC Profile
C2C-CC Basic System Standards Profile	BSP	v 1.3 (2018)	Specifies Transmit Rate Limit for C2C-CC DCC Profile. C2C-CC profiles are implementation guidelines for interoperability among ITS-Stations

DCC Access obtains the CBR, which is calculated as the percentage of slots found busy during an observation window. As a function of the CBR, it performs traffic shaping via queuing and flow control to limit the transmit rate.

DCC Facilities is being designed [30]² to limit the transmit rate, by limiting the

²still a draft at the time of writing

generation of packets by the services. DCC Management exchanges information such as channel load across different layers, while DCC Network facilitates the exchange of information, such as the global channel load, among the nodes.

As ETSI DCC is a key aspect of this thesis, it has been analyzed in detail in the next chapter. Nevertheless, a brief description of the ETSI transmit rate control at the Access layer is presented below.

There are two mechanisms specified by ETSI for transmit rate control at the Access layer, i) Reactive and ii) Adaptive.

2.4.1.1 Reactive Transmit Rate Control

In Reactive TRC mechanism, the CPS reacts to the absolute value of the physical component, i.e. the Channel load, measured as a Channel Busy Ratio (CBR) metric. Accordingly, the transmit rate is immediately adjusted. The DCC mechanism specified by C2C-CC adopted this approach for TRC ³.

The Reactive TRC works via a state machine to adjust the physical response of the CPS to the context of the ITS-G5 channel. A graduated yet predefined response of the CPS will take place, depending if the channel is in a RELAXED state, a set of ACTIVE states, or a RESTRICTED state. Changing these states solely depends on the CBR measurement.

Table 2.5: Rate Control Parameters for Reactive Access DCC in C2C-CC specification[7]

State	Channel Load %	Toff (ms)	Tx Rate (Hz)
relaxed	$0\% \geq CL < 19\%$	60	16.7
active_1	$19\% \geq CL < 27\%$	100	10.0
active_2	$27\% \geq CL < 35\%$	180	5.6
active_3	$35\% \geq CL < 43\%$	260	3.8
active_4	$43\% \geq CL < 51\%$	340	2.9
active_5	$51\% \geq CL < 59\%$	420	2.4
restricted	$CL \geq 59\%$	460	2.2

Then, the cyber layer of the system is set to restrict the access to the ITS-G5 channel, via a parameter called *Toff*, which corresponds to blocking the access to the ITS-G5 channel for a given time interval, and consequently reducing the load on the channel. Various *Toff* times have been specified by ETSI and C2C-CC to optimize the control of the reactive DCC on the ITS-G5 channel as illustrated in Table 2.5.

A criticism addressed to the reactive DCC approach is that it focuses on its fast reactivity to channel load and aims to limit the channel usage at any cost, i.e. without considering the node density or without attempting to exploit the available channel capacity, as analyzed in the next chapter. Generally, the higher the packet transmit or packet reception rate, the better it is for safety related ITS applications such as cooperative awareness. Therefore, as explained below, an Adaptive DCC mechanism has been incorporated into the revised ETSI standard, which aims to maximize the transmit rate allocation to nodes by exploiting a target channel capacity while aiming to maintain the overall channel load within a maximum limit.

³As Transmit Rate Control is the sole method of DCC in Europe, the terms DCC and TRC are used interchangeable

2.4.1.2 Adaptive Transmit Rate Control

In Adaptive DCC mechanism, the CPS does not react to the absolute CBR measurement, but rather to the difference between a target CBR value and the currently measured CBR. Adaptive DCC does not have any predefined reaction to a given CBR, but instead constantly adapts the response to converge to the target CBR, in a controlled way.

The adaptive DCC algorithm specified in the ETSI standard is based on LIMERIC [51], which controls the transmit rate as:

$$R(t) = \alpha R(t-1) + \beta(CBR^{target} - CBR(t-1)) \quad (2.1)$$

In the LIMERIC algorithm, the transmit rate R at time or step t , is a function of the last transmit rate (multiplied by a memory level α), plus the different between the current CBR and the target CBR, multiplied by a weight β . In other words, it iteratively changes the transmit rate, with a goal to converge the CBR towards a target CBR. The parameters α and β ensure system stability, i.e. the speed at which the CPS system converges to a target transmit rate and whether the rate remains within bounds of the point of convergence.

An important feature of LIMERIC is its adjustment of the transmit rate to the difference between the current CBR and the target CBR. This allows having strong reactions (radical change in the transmit rate) when the difference between the target CBR and current CBR is large, and smaller fine-grained adjustments when the difference is small, ensuring stability.

The main goal of any congestion control mechanism is to maintain the channel load below a threshold. However, the channel load does not only depend on the transmit rate but also depends on the packet size. Therefore, in the ETSI standard, the parameter R in the above equation has been replaced by a duty cycle parameter called δ , to include the impact of packet size. This has been presented in Chapter 3, along with other details of the ETSI DCC mechanism, such as how these methods are implemented in the stack.

The channel congestion control in the USA has been presented in the next subsection.

2.4.2 SAE Congestion Control Standard

In the USA, SAE has standardized a channel Congestion Control Algorithm (CCA) in 2016, defined in SAE J2945/1 [37], for controlling the transmit parameters based on the channel condition. There are four external input parameters, i.e. Channel Load, Packet Error Rate, Neighbor tracking Error and Neighbor Density, influencing two control parameters, i.e. the transmit power and the decision to transmit or not.

Unlike the European approach, as discussed above, the transmit rate is not a direct function of the channel load, but rather the system aims to minimize the transmission to ensure a minimum application performance measured via the metric Neighbor Tracking Error.

Figure 2.16 shows the working of the CCA algorithm. A transmission can be triggered via 3 conditions:

- **Tracking Error:** An ego-node estimates the perception that its neighbors have about its ego position. The uncertainty of the perceived position, a.k.a

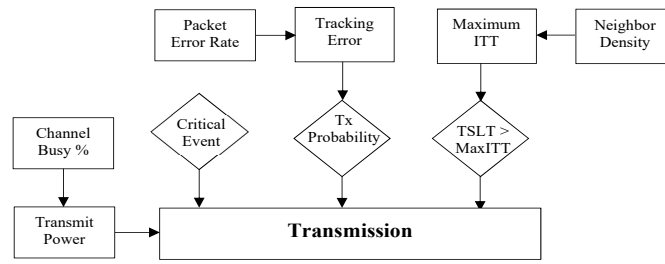

Figure 2.16: SAE Congest Control Algorithm

tracking error (TE) increases as the time since last transmission increases. A metric called transmission probability (TP) is used to decide the transmission. If the tracking error exceeds 0.5m, the TP becomes 1 and a BSM is transmitted immediately, otherwise the TE is between 0 and 1. Moreover, the Packet Error Rate (PER) at the ego-vehicle, which gives an indication of the channel quality is used to calculate the TE. A high PER, decreases packet reception by the neighboring vehicles, in turn increasing the TE.

- **Critical Event:** In case of a road emergency, such as hard braking or any other critical event, a node immediately transmits a BSM.
- **Maximum ITT:** If a BSM has not been transmitted since the last transmission via the above conditions, then it is transmitted if the time has elapsed Max_ITT, which in turn varies dynamically as a function of the neighbor density within a radius of 100m. If the neighbor density is less than or equal to 25 vehicles, the ITT is 100ms, while if it is more than 150 vehicles, then the ITT is 600ms, and varies linearly in between.

The transmit power, a.k.a Radiated Power (RP) in the standard, is calculated as a function of the Channel Busy Percentage (CBP). The RP is between 10 and 20 dBm when the CPB is between 50 and 80%, and has the following relation in between:

$$f(CPB) = \begin{cases} vRPM_{ax} & CPB \leq vMinChU \\ vRPM_{ax} - \left(\frac{vRPM_{ax} - vRPM_{in}}{vMaxChU - vMinChU} \right) \times (CPB - vMinChU) & vMinChU < CPB < vMaxChU \\ vRPM_{in} & vMaxChU \leq CPB \end{cases} \quad (2.2)$$

In the equation, $vRPM_{ax}$ is the maximum power (20 dBm), $vRPM_{in}$ is the minimum power (10 dBm), $vMinChU$ is the lower threshold for channel utilization (50%), and $vMaxChU$ is the higher threshold for channel utilization (80%). The RP is smoothed out using:

$$NewRP = PreviousRP + 0.5 \times (f(CBP) - PreviousRP) \quad (2.3)$$

2.5 Differences between standards in Europe and USA

As presented in the earlier sections, there are few key differences between the ETSI ITS stack and the IEEE Wave protocol stack. Firstly, the channel usage in WAVE

is specified by the standard WAVE 1609.4 as a separate functionality at the MAC layer, whereas in Europe it is integrated with the channel congestion control mechanism. Similarly, there are slight differences regarding the channelization and the maximum transmit power.

The Network and Transport layers are quite different, with the ETSI stack implementing geographical addressing and routing using the GeoNetworking protocol, while IEEE Wave uses WSMP, which does not define Network layer protocols, but only provides APIs. Similarly, there is a Facilities layer in the ETSI stack, acting as a middleware layer and managing the messages and services, whereas in the WAVE stack, there is a message sub-layer within the Application layer.

An important difference is in the channel congestion control approach. In the USA, congestion control has been developed by SAE and not IEEE. As SAE focuses on the higher layers and IEEE on the lower layers, consequently congestion control has been developed at the Service layer. However, in Europe, ETSI has control over the full protocol stack and congestion control has followed a cross layer approach, with more emphasis at the lower than the higher layers.

Similarly, ETSI has specified only Transmit Rate Control via a reactive mapping of channel load to transmit rate via table lookup or an iterative adaptation of transmit rate to reach a target channel load. The SAE standard in the USA specifies power control w.r.t channel load and transmit rate control w.r.t neighbor tracking error and neighbor density. However, to the best of our knowledge, the SAE congestion control has been designed for a single message, whereas the ETSI standard additionally provides mechanism to allocate transmit rate among several services of a node, as detailed in the next chapter.

Nevertheless, the Physical layer, MAC and LLC sub-layers are almost the same in both the standards. A comprehensive summary of the standards in the USA has been presented in [52], and a similar summary for European standards has been presented in the paper [53].

A high level description of the SAE CCA has been presented here, and for further details, the reader can refer to SAE J2945/1 [37]. As the standard is not freely accessible, the work in [54] gives an overview of the SAE congestion control algorithm.

2.6 Literature Review: Channel Congestion Control

Vehicular networks have been designed to function in an ad-hoc manner without any centralized scheduler or network resource allocator. The PHY and MAC layers of leading vehicular communication technologies i.e. DSRC in the USA and ITS-G5 in Europe are based on IEEE 802.11p, using CSMA/CA medium access control to stochastically allocate temporal channel resource among contending nodes.

Operating in ad-hoc mode, V2X communication technologies leave each node autonomously contend for channel access. Uncoordinated, such contention-based channel access may lead to severe packet collisions or channel resource exhaustion by potential selfish nodes. Moreover, most V2X safety services rely on broadcast transmissions only, collisions cannot be corrected. Therefore if individual transmissions are not regulated, collisions rapidly increase with the number of neighbors,

creating scalability concerns.

In order to solve this problem, channel congestion control protocols have been developed to limit the transmit parameters, mainly transmit rate and power, of each vehicle based on channel condition. Rate control sets the maximum number of transmissions allowed in a given period to limit the temporal utilization of channel, while power control sets the maximum power to limit the spatial channel utilization and optimize spatial reuse of wireless resources.

DCC has been extensively studied in the literature and many protocols have been proposed for congestion control and resource allocation.

2.6.1 Transmit Rate Control

Among the congestion control mechanisms, Transmit Rate Control (TRC) has been most widely investigated in the literature. Linear Message Rate Control (LIMERIC) [51] is a distributed rate control algorithm, where each vehicle uses a linear feedback loop to periodically measure the CBR and iteratively adapt the Inter Transmit Time (ITT) or transmit rate to reach a target CBR. LIMERIC is further explained in Chapter 3, as the adaptive version of ETSI DCC transmit rate control [5] has been based on it.

Periodically Updated Load Sensitive Adaptive Rate control (PULSAR) [55] is another rate control algorithm, where each vehicle sets a target channel load such as 0.6 and additively increases the transmit rate if the measured channel load is below the target, otherwise decreases in a multiplicative way if the load exceeds the target, while maintaining a maximum and minimum bound for the transmit rate. Additionally, PULSAR introduces two-hop piggybacking of channel load measurement, and nodes use the global maximum channel load. In case of heterogeneous node density, a node can contribute to channel load at a distance, while its immediate vicinity can be sparse, producing a low local CBR. A similar approach using TCP like AIMD for rate control has been proposed in [56].

2.6.2 Transmit Power Control

In addition to TRC, Transmit Power Control (TPC) has been extensively analyzed in the literature. One of the earliest power control approaches in vehicular networks is called Distributed Fair transmit Power Adjustment (D-FPAV) [57], which proposes a different power control for beacons and event driven messages while ensuring max-min fairness in the network. The algorithm sets a target channel capacity for beacons and each node calculates the optimal transmit power by considering the neighbor density to maintain the overall channel load below the target.

The study in [58] proposes a mechanism called Random Transmit Power Control (RTPC). For each CAM transmission, a node chooses a transmit power within an interval and all the nodes use the same probability distribution to ensure fairness. By randomizing the transmit power the goal is to vary the collision and interference range of each transmission, in order to avoid that same two hidden nodes persistently interfere with each other's periodic transmission. Similarly, another study [59] proposes oscillating the transmit power between two levels. It uses a lower power for several consecutive message transmissions followed by a transmission using higher power.

The study in [60], proposes state based TPC, by mapping channel load to transmit power similar to the classical approach of DCC power control [10], standardized by ETSI in 2011. Additionally, the paper proposes a synchronous time division multiplexing on top of CSMA, with a goal to distribute the transmissions over time and decrease concurrent transmission and collision.

A different approach is used to control the transmit power, i.e. based on the current speed of the vehicle in [61]. Transmit rate control based on speed and neighbor tracking error had been proposed in prior studies [62, 63], as mentioned earlier. The study in [61] uses a similar reasoning, i.e. a vehicle with higher speed has a lower time to collision, therefore should use higher power to communicate its status information to a higher number of neighbors.

Similarly, other approaches of transmit power control have been proposed in other studies such as [64–66].

2.6.3 Combined Transmit Rate and Power Control

The authors of [58], combine their random transmit power control mechanism with rate control in the study [67], to increase the transmit rate until a target channel load. Similarly, the study proposes an optimal distribution for randomizing the power, to maintain an optimal spatial awareness range. A similar approach of combining rate and power has been presented in [68], to maintain a target average level of awareness or Inter Reception Time (IRT) at a target awareness range. The algorithm first sets the awareness range, then adjusts the transmit rate to maintain the channel load under threshold and subsequently applies power control when the awareness range changes.

Although the above approaches use joint power and rate control but the two control processes are distinct. However, the authors in [69] use a single loop to control both rate and power. In this approach, nodes cooperatively use their contextual factors to choose the transmit power, for example nodes not facing a road emergency decrease their transmit power to allow other nodes in hazardous situation to increase their transmit rate.

2.6.4 Controlling other parameters

In the literature other approaches have been proposed, using other control parameters to limit the channel load while maintaining a minimum level of application performance. The study by Sepulcre et al. [70], proposes adapting the data rate instead of using the default 6 Mbps, proposed in other studies such as [46]. The findings in [70] suggest that the reduction in packet airtime by increasing the MCS decreases the channel load and reduces collision, thus improving application performance. Another study [71] combines TRC and with data rate control. During high node density when TRC cannot provide the minimum required transmit rate, data rate is increased to gain further channel capacity.

Other studies such as [72], have proposed adjusting the carrier sense (CS) threshold of each node based on the neighbor density. By reducing the CS threshold, a node is more aware of transmissions by hidden nodes, thereby reducing hidden node collisions. The study concludes that CS threshold can be adapted to achieve an optimum packet reception probability for a target range, w.r.t to the neighbor density.

A survey of channel congestion mechanisms can be found in [73, 74].

2.6.5 Awareness Control

Although TRC limits the maximum rate w.r.t to channel load, but it can be aided by another metric to generate only the adequate number of packets, required to satisfy the application of the node. In this regard, a term called awareness control has been introduced by the paper [75], which differentiates between congestion and awareness control.

The awareness control protocol EMBARC [76] extends the rate control of LIMERIC, and uses two thresholds having different weights to transmit the next CAM/BSM. The first threshold is the ITT allowed by LIMERIC w.r.t to the channel load and the second threshold is the neighbor tracking error, proposed by [77]. Tracking error is basically the difference between a node's ego position and the its position perceived by its neighbor. If the difference between these two exceeds a threshold, the ego node emits a message. Consequently, highly dynamic nodes transmit more than less dynamic nodes.

The original idea of reducing channel congestion by transmitting at a minimum rate needed to maintain the tracking error below threshold was proposed in [62]. This concept has been used for standardization in the SAE standard for channel congestion control in the USA [41].

Similarly, another awareness control protocol called INTERN [78], extends the congestion control approach of LIMERIC and integrates awareness control. LIMERIC sets a target channel load and allocates a similar target transmit rate to neighboring vehicles for fairness. Whereas INTERN proposes that vehicles should be allocated the minimum rate required by its applications, and if the minimum transmit rate cannot be satisfied, then neighboring vehicles should have the same difference in the required and allocated transmit rate to ensure fairness.

2.6.6 Channel Congestion Control for Multiple Packet Types

Almost all of the aforementioned papers analyze channel congestion control using only a single beaconing message i.e. CAM/BSM in the channel. However, as mentioned in the previous chapter, there is a high possibility of using the channel for multiple types of messages in future V2X scenarios, which has been analyzed in this thesis. A study [79], looks into adapting rate and power for multiple applications, which depend on a single message.

Only recently few studies have started considering the issue of channel congestion control taking into account multiple messages. The study in [36] investigates CAM with Collective Perception Message (CPM) and demonstrates from a high level the problem of starvation of lower priority traffic during channel congestion. The study [80] analyzes CAM and DENM, and observes starvation of CAM during resource insufficiency to transmit both CAM and DENM. Similar conclusion regarding starvation using multiple packets have been drawn in [35].

Kuhlmorgen et al. [81], similarly analyze the problem of starvation due to simple priority based queuing and flow control at the Access layer. The paper also evaluates Weighted Fair Queuing (WFQ) to remedy the starvation problem of lower priority

traffic. However, the performance improvement to lower priority packet comes at a larger cost of non-proportional performance degradation of higher priority packets.

2.6.7 Beyond State of the Art

In order to remedy problems of channel congestion control mechanisms regarding inefficient traffic shaping at the Access layer, in this thesis we propose dynamic packet prioritization at the Service layer. Instead of static traffic prioritization, queuing and flow control at the Access layer, we propose to shift the traffic shaping intelligence at the service layer and design a resource orchestrator on top of standardized ETSI DCC. Similarly, most of the aforementioned studies look at channel congestion control from a theoretical viewpoint. However, in this thesis, the main goal is to look at the issue from an implementation viewpoint, i.e. analyzing the performance of standardized protocols and how the ITS communication stack standardized by ETSI manages multiple safety messages during channel congestion.

Moreover, another problem addressed in this thesis is the heterogeneous channel resource allocation to vehicles, which has not also been analyzed much in previous studies, except a few such as [82]. In aforementioned studies on awareness control [76, 78], the transmit rate and vehicles transmit only the amount required to satisfy an awareness metric, thereby nodes with different mobility transmit different amounts. However, by heterogeneous allocation we mean that nodes with different number of applications are allocated different channel usage quota, and the allocation is executed cooperatively among the nodes in a decentralized manner.

A comparison of the related work is presented in Table 2.6, with regards to the problems addressed in this thesis. Similarly, Table 2.6 shows what is missing in the related work and thus the gaps filled by this thesis.

2.6.8 5.9 GHz Spectrum Sharing between ITS-G5/DSRC and other technologies

Since the beginning of the discussion of sharing the spectrum reserved for V2X communication with other technologies such as WiFi around 2015-16, several studies have investigated the possibility of such coexistence and performance impact of one technology over the other and vice-versa.

Lui et al. [85] evaluated the impact of IEEE 802.11ac on DSRC based safety V2X communication, and highlighted the harmful impact of WiFi on DSRC, which may be reduced by controlling the Interframe Space (IFS) of WiFi. Naik et al. [86], investigated the coexistence from the viewpoint of WiFi and concluded that using high-bandwidth WiFi modes is unfeasible due to the harmful interference on DSRC. Similarly, the study proposed a dynamic WiFi re-channelization approach to improve the throughput of Wi-Fi Access Points (AP).

The studies [87, 88], evaluated two protocols proposed for standardization for spectrum sharing, called Detect and Mitigate (DAM) and Detect and Vacate (DAV). The authors of [87] demonstrated that DAM performs worse than DAV, causing 30% more packet loss. The study in [88] provided similar evaluation regarding DAM, and pointed out that detection of DSRC signal by WiFi is the primary challenge, and detection is more difficult for indoor WiFi APs than outdoor.

Table 2.6: A comparison of related work w.r.t problems addressed in this thesis

Research Paper	Congestion Control Method	Multiple Messages	Flexible Message Priority	Heterogeneous Allocation
Bansal et al. (Limeric) [51]	Transmit Rate	No	No	No
Tielert et al. (Pulsar) [55]	Transmit Rate	No	No	No
Ruehrup et al. (AIMD) [56]	Transmit Rate	No	No	No
Gunther et al. [36]	Transmit Rate	Yes	No	No
Kuhlmorgen et al. [83]	Transmit Rate	Yes	No	No
Kuhlmorgen et al. [81]	Transmit Rate	Yes	Yes	No
Bansal et al. [82]	Transmit Rate	No	No	Yes
Bansal et al. (EMBARC) [76]	Transmit Rate + Neighbor Tracking Error	No	No	No
Huang et al. (IVTRC) [77]	Transmit Rate + Neighbor Tracking Error	No	No	No
Sepulcre et al. (INTERN) [78]	Transmit Rate + Awareness	No	No	No
Moreno et al. (D-FPAV) [84]	Transmit Power	No	No	No
Kloiber et al. (RTPC) [58]	Transmit Power	No	No	No
Willis et al. [59]	Transmit Power	No	No	No
Subramanian et al. [60]	Transmit Power	No	No	No
Joseph et al.	Transmit Power	No	No	No
Kloiber et al. (RTPC + TRC) [67]	Transmit Power + Rate	No	No	No
Ruffini et al. [68]	Transmit Power + Rate	No	No	No
Baldessari et al. [69]	Transmit Power + Rate	No	No	No
Sepulcre et al. [79]	Datarate + Power	No	No	No
Math et al. [71]	Transmit Rate + Datarate	No	No	No
Stanica et al. [72]	Carrier Sense Threshold	No	No	No
Our Approach	Transmit Rate	Yes	Yes	Yes

The mechanism of spectrum sharing between WiFi and DSRC/ITS-G5 follows the principle that WiFi should liberate the channel upon detecting DSRC signal using an approach similar to cognitive radio (CR). CR networks have been investigated in details over the last decade. Besides the seminal work from Goldsmith et al. [89], Akyildiz et al. [90, 91] described main challenges behind Cognitive Radio (CR) from a hardware and protocol perspective. Detailed descriptions of the challenges and potential strategies may also be found in surveys [92, 93]. Several works introduced enhanced or new WiFi MAC protocols supporting CR networks [94, 95]. And more recently, CR approaches applied to vehicular networks have also been proposed and discussed in detail in [96–100].

2.7 Existing Design Philosophy

2.7.1 Bottom Up Approach

The existing Design Philosophy for V2X communication has been bottom up instead of top down. The approach has been first consolidating the communication technology i.e. ITS-G5 and DSRC, and the lower layers of the communication stack, before moving on to the upper layers, such as GeoNetworking, Facilities and Application Layers.

Consequently some assumptions had to be made regarding the application behavior, such as safety messages are periodic, vehicles emit mostly a single type of message, i.e. 10Hz CAM and nodes have similar capabilities and communication needs. Thus the lower layers were designed without considering the complexities of the applications.

This was also the approach for designing the ETSI channel congestion control mechanism, and a lot of the intelligence for controlling channel congestion have been put into the lower layers, which have been later found to be problematic for application performance. For example, receiver based GeoNetworking multi-hop forwarding works on the principle that the forwarder closest towards the destination gets the shortest back-off time. However, as shown in studies [80], this functionality is jeopardized when congestion control adds another layer of delay, which is in no way related to the distance between nodes. Therefore the study in [80], proposed a repair work to the ETSI DCC protocol to adapt it to the distance based forwarding mechanism.

Similarly, a token bucket rate control at the Access layer was specified in the EU Delegated Act [9] for controlling the transmit rate of emergency messages, allowing a small burst of fixed size, which has been in the standards of C2C-CC [101] since 2014. However, only when it was eventually integrated into the EU Delegated Act in 2019, it was found to be inadequate by stakeholders in the V2X safety application ecosystem, and is currently being modified.

This problem is not only limited to IEEE 802.11p based DSRC/ITS-G5, but LTE-V2X also, which although being conceived almost a decade after DSRC/ITS-G5, faces similar issues due to the bottom up design philosophy. The MAC of LTE-V2X Mode 4 involves semi-persistent scheduling and reservation of fixed size resource blocks, which can suffice for periodic packets, but may be challenging when the packet arrival rate and the packet size varies dynamically as in the context of safety V2X communication. Similarly, the congestion control mechanism of LTE-

V2X Mode 4 involves packet dropping at the Access layer, which has proven to degrade the performance of semi-persistent scheduling as shown in [48].

2.7.2 Our Proposition: Top Down Approach

We propose a top down approach to congestion control in this thesis, and move up the channel congestion control intelligence, from the Access to the Facilities layer. We propose to keep the Access layer simple, for example it can just ensure that the node is respecting the channel usage limit, but the intelligence of traffic shaping should belong to the Facilities layer, and not the Access layer.

Existing standardized DCC mechanisms at the Access layer regulate the transmit rate, but without considering the heterogeneous message characteristics, it penalizes services. Similarly, Access layer congestion control strategies can drop or delay packets via queuing and flow control, as detailed in the next chapter. However future V2X scenario will require smarter strategies to distribute the scarce network resource or transmit opportunity among multiple applications with heterogeneous characteristics. The channel congestion control and resource allocation should allow dynamically prioritizing packets as a function of the application's needs and context, instead of classifying applications via fixed traffic classes, as done currently.

As the application complexity will increase the network protocols may have to be re-designed by considering the application requirements. In this regard, a good strategy is to keep the physical layer simple, and move the control intelligence up the stack and making it more flexible and adaptable. Similarly, implementation in the upper layers will make it easily upgradable to advances in vehicular communication needs, instead of re-designing the lower layers and upgrading the firmware or the hardware chipset.

Moreover, it is machine to machine communication, and the capability and communication needs of machines (vehicles in this case) evolve more rapidly than pc or smartphones, so the arguments for flexibility and forward compatibility are much more necessary for V2X communication. This argument of shifting the network control intelligence, is also shared by other paradigm shifts in the field of networking in general, such Network Function Virtualization (NFV).

Thus, the MAC layer congestion control strategies designed for ITS-G5 may be useless if the technology itself becomes extinct. This was not easy to predict back then, but considering this fact would have caused congestion control such as ETSI Decentralized Congestion Control to be developed more at the upper layers (albeit with an abstraction layer) rather than at the Access layer.

The next chapter details the challenges of channel congestion control, and describes the issues addressed in this thesis.

Chapter 3

Problem Statement

3.1 Introduction

The chapter details the mechanism of decentralized congestion control in European standards and discusses in detail the issues about congestion control and channel resource allocation addressed in this thesis. It starts by presenting the general challenges of vehicular networks, along with the challenges of spectrum sharing and its impact on V2X communication. Afterwards, the two viewpoints of ETSI transmit rate control have been presented, i.e. as a mechanism for decentralized rate control and mechanism for decentralized channel resource allocation.

Resource allocation has been in turn split into two dimensions, i.e. In-vehicle and Inter-vehicle, as both these aspects have been analyzed in this thesis. Similarly, as this thesis addresses rate control for multiple applications, the Quality of Service (QoS) mechanisms at different layers of the ETSI and C2C-CC protocol stack have also been presented in this chapter. Similarly, the important components of standardized transmit rate control have been analyzed, such as queuing, flow control, Reactive and Adaptive transmit rate control, packet generation control etc, have been analyzed. The chapter ends with a discussion of our proposed paradigm shift and the need for one of the main contributions of this thesis, i.e. a resource orchestrator in the protocol stack, at the Service/Facilities layer.

3.2 General Characteristics & Challenges of Vehicular Networks

3.2.1 Decentralization

In IEEE 802.11p based vehicular networks, there is no centralized channel resource allocator and transmission opportunity is allocated stochastically using CSMA/CA Medium Access Control. A node senses the channel, a.k.a Clear Channel Assessment (CCA) and transmits if the medium is sensed free. If it is found busy, the node stochastically obtains a random backoff window, and transmits when the backoff counter finishes. Stochastically allocated transmit opportunity leaves the possi-

bility that multiple nodes may finish backoff counter simultaneously and transmit, causing packet collision.

The other major source of packet collision is from nodes outside the Carrier Sense range, i.e. hidden to each other. In such a scenario, nodes far from each other cannot detect each other's transmissions due to signal attenuation, thereby transmitting simultaneously, resulting in packet collision at receivers between those two nodes.

3.2.2 Dynamicity

The context of a V2X communication is very dynamic as the nodes are highly mobile, with varying channel condition, node density, packet generation requests etc. The scope of this thesis is mainly Single Hop Broadcast (SHB) safety communication and routing/forwarding and session based V2X communication is out of scope. Nevertheless, SHB communication depends on several dynamic factors which can be analyzed using the block diagram of Figure 3.1.

A node's context varies according to its mobility and the road traffic scenario, which in turn influences the triggering of motion triggered message such as CAM or event triggered messages such as DENM or CPM, as explained below. Similarly, the node's mobility and road traffic scenario affects the number of neighboring nodes competing for channel access and thus the channel load.

Similarly, the channel load influences the resource available for each node, calculated by the Channel Congestion Control mechanism. The Congestion Control block limits mainly the packet transmit rate and/or power to limit channel congestion, by limiting packets into the channel and respecting the individual channel usage limit. The transmitted packets in turn influence the channel load and the dynamic cycle continues.

From a networking viewpoint, the number of messages to be transmitted varies dynamically w.r.t the external context, while the channel resource or the transmit opportunity for the node may decrease dynamically if the channel load or neighbor density increases. In such a context, a node needs to optimize and efficiently use its channel usage, which has been addressed in this thesis.

3.2.3 Heterogeneous Network Traffic Pattern

V2X safety messages can be commonly thought to be mostly periodic broadcast, but in reality the messages can be quite heterogeneous with variable network traffic pattern. As described in Chapter 2, CAMs are triggered by vehicle mobility, and triggered by time if the mobility is not sufficient to trigger CAMs. Therefore CAMs are transmitted regularly with a variable periodicity.

DENMs are event triggered, therefore can be thought to be bursty, whereas the packets can be periodic inside each burst.

CPMs are event triggered, i.e. upon detection of new objects and upon a sufficient change of mobility of already detected objects. Unlike DENMs, CPMs are not bursty and a node emits at least one CPM, making CPMs both time and event triggered. The traffic pattern of CPMs may be classified similar to CAMs, i.e. regular transmission with variable periodicity.

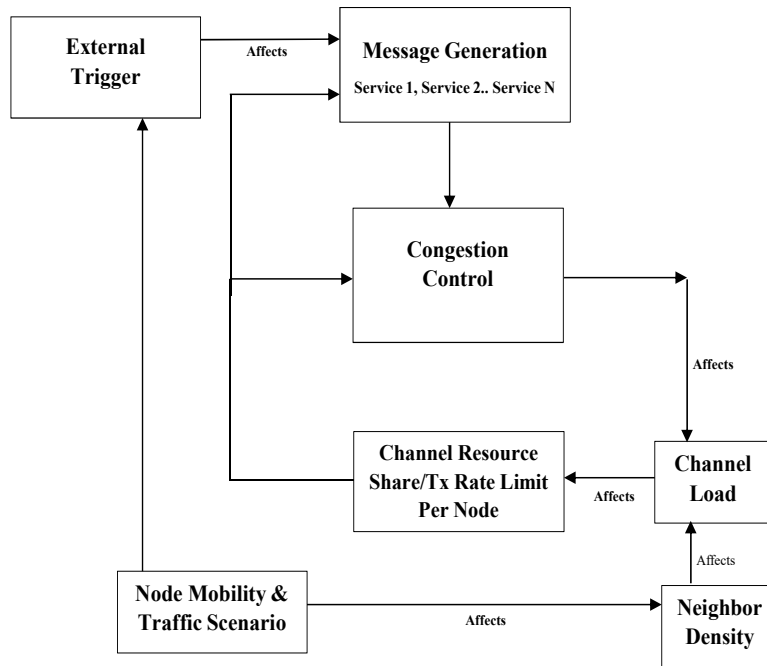

Figure 3.1: Block Diagram for dynamicity in vehicular communication

Similarly, the size of each packet from the same service can vary dynamically on the information content, path history, type of event, number of sensors/objects detected, security header/trailer etc. Moreover, the messages have different priority levels, which are mapped to 4 Traffic Classes (TC) 0 to 3, as explained later.

Thus, the communication requirements of nodes can dynamically increase, based on mobility and external events, while the availability of communication resource is not guaranteed, varying dynamically on the channel load and neighbor density.

3.2.4 Heterogeneity in Communication Resource Requirement

As mentioned in Chapter 2, during initial V2X communication deployment, vehicles are expected to have a limited set of services and the number of services per vehicle will usually be similar. However, for future deployment scenarios, vehicles will have diverse capabilities, varying degree of autonomy and communication requirements. For example, an autonomous vehicle will have more services requiring safety V2X communication, than a human driven legacy vehicle. Therefore, heterogeneity in communication resource allocation among neighboring nodes in a decentralized manner while ensuring fairness and safety applications requirements, is key in such a communication scenario, which has been addressed in this thesis.

3.2.5 Losing the dedicated spectrum for ITS communication

As discussed in Section 2.3, the dedicated frequency spectrum reserved for ITS communication may have to be shared with other ITS technologies i.e. LTE-V2X and

WiFi, which adds further challenges for IEEE 802.11p based V2X communication. The coexistence challenges with WiFi have been illustrated in this subsection.

3.2.5.1 Co-Existence Challenges between ITS-G5/DSRC and WiFi

In Europe and USA, regulators agreed that due to the safety-critical nature of IEEE 802.11p traffic, it should remain the primary user of the coexisting band, and WiFi should follow a generic *detect-and-avoid* cognitive radio strategy to prevent harmful interference. Although originating from the same root, the coexistence between IEEE 802.11p and WiFi is not straightforward. Without loss of generality, we describe several challenges that could risk the performance of ITS-G5/DSRC due to this spectrum sharing, even though it will be the primary user.

3.2.5.1.1 Physical Layer Challenges of Coexistence

Reduction of Awareness: WiFi operates on 20MHz or wider channels while ITS-G5 channels are 10MHz. During Clear Channel Assessment (CCA), ITS-G5 or WiFi cannot decode each other's preamble at -85dBm in order to declare channel busy. Thus, ITS-G5 can assess the channel busy for a WiFi signal and vice versa only 20dB above this minimum sensitivity at -65dBm. Consequently, the ITS station needs to move much closer to WiFi in order to detect and be detected by WiFi, which corresponds to a loss of awareness.

Asymmetric Detection: As ITS-G5 cannot be modified to operate on 20MHz channels, WiFi coexisting with ITS-G5 has been proposed in the standard to have a 10MHz detector, which will enable WiFi to decode ITS-G5 preamble and detect channel busy at -85dBm. Nevertheless, WiFi will still remain **unilaterally hidden** to ITS-G5, unless the latter comes close enough to detect WiFi signal at -65dBm.

Figure 3.2 visually illustrates this asymmetric detection and the unilateral hidden problem. It corresponds to an intersection, with a corner equipped with a WiFi Access Point (AP). As V1 approaches the WiFi AP, it moves through three zones, with different degree of visibility:

- **Zone 1:** both V1 and WiFi AP are too far and outside the detection range and may interfere with each other. Any other ITS station at the intersection with its minimum sensitivity of -92dBm for ITS-G5 signal, would be able to detect V1 in Zone 1. However WiFi with the -85dBm sensitivity of its 10MHz detector, cannot detect ITS stations in this zone.
- **Zone 2:** the awareness range of WiFi starts from here so WiFi may detect ITS-G5 signal at -85dBm and engage a mitigation strategy (explained later). However V1 (with -65dBm CCA sensitivity), yet cannot detect WiFi and will transmit ignoring WiFi transmissions. WiFi is unilaterally hidden to ITS-G5 and this zone is critical for coexistence.
- **Zone 3:** V1 is close enough to detect WiFi signal at -65dBm and assess the channel busy. Both WiFi AP and V1 are visible to each other, resulting minimum interference in this zone.

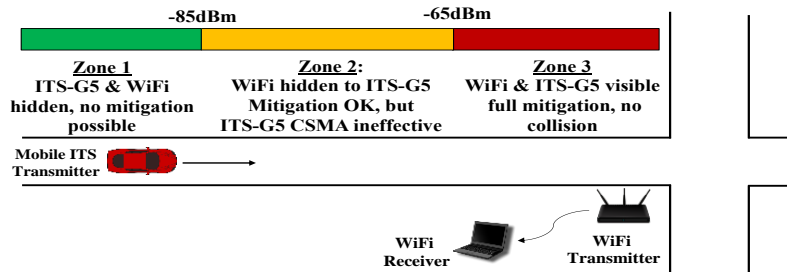

Figure 3.2: Three Zones of visibility between ITS-G5 and WiFi

3.2.5.1.2 MAC Layer Challenges of Coexistence The CAM/BSM are the two major safety-related messages used by IEEE 802.11p. In both ETSI ES 202 663[102] and SAE J2945/1 [37] standards, CAM/BSM are broadcast with the access category *Best Effort (AC_BE)*. This gives it a handicap when competing for the channel against high demanding unicast WiFi traffic, which can be on more stringent access categories, such as *Voice (AC_VO)* or *Video (AC_VI)*. Accordingly, CAM/BSM might either be delayed or lost due to WiFi packets.

To summarize, the problem deals with channel access contention between two types of transmissions. On one side there is WiFi, which is unicast with acknowledgment, can have higher EDCA priority, larger packet size, higher packet frequency compared to ITS-G5. Moreover, ITS-G5 significantly suffers from the loss of awareness when detecting WiFi signal. In spite of all these handicaps, ITS-G5 communication is for critical safety-of-life and traffic efficiency applications and has to remain the primary channel user, against infotainment WiFi communication.

3.3 System Description & Key functions of Congestion Control

The goal of Decentralized Congestion Control process is to ensure the following objectives :

- **Fairness:** Allocate channel resource and channel access opportunity in a fair manner among neighboring ITS stations
- **Channel Capacity Allocation & Reservation:** Maintain overall channel load from non-priority broadcast messages below pre-defined threshold, while reserving ample channel capacity for emergency messages
- **Adaptability:** Adapt quickly to external conditions, namely variation in channel load
- **Stability:** Limit oscillations in the control process and avoid continuous fluctuation of control parameters such as transmit rate

As shown in Figure 3.3, the control process starts by measuring the channel load, every 100ms which sets the Channel Resource Usage Limit for the node. For Transmit Rate Control, the Resource Limit is used to limit the Transmit Rate, calculated via either an Adaptive or Reactive process, as explained later in Section 3.4.2. The Transmit Rate Limit is enforced via a queuing and flow control at the Access layer. Additionally, the node's transmit rate limit may be used to limit the

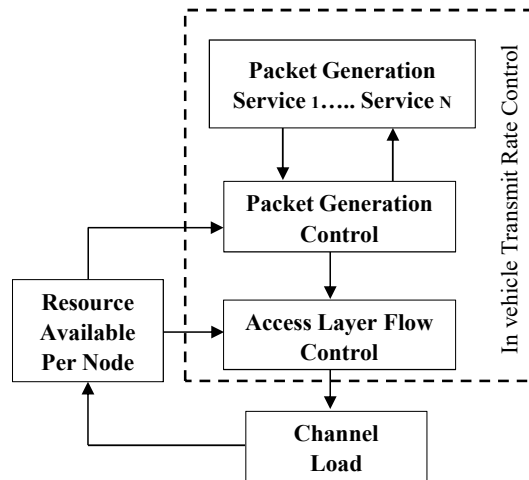

Figure 3.3: Transmit Rate Control Block Diagram

generation of packets at the upper layer. We distinguish between the macroscopic network wide viewpoint as Inter-Vehicle Resource Allocation (IVRA), while the microscopic viewpoint inside a node we refer to as In-Vehicle Transmit Rate Control (IVTRC).

3.3.1 Inter-Vehicle Resource Allocation

As mentioned above, one of the goals of DCC is to ensure fairness while controlling the rate of individual nodes. In ETSI standards [32, 103], it is defined as: “Any ITS-S under the same channel conditions has an equal opportunity of accessing the radio channel for periodic messages, while maintaining a channel access margin to always allow the exchange of safety-critical event-based messages.” Similarly, the congestion control process should reserve some channel quota (usually 1/3rd or 30%) for high priority safety critical messages, and the rest of the channel capacity can be equally shared among neighboring nodes facing similar channel conditions, which can be expressed in a simplified way as:

$$ChannelResourceLimit_{perNode} = \frac{ChannelUsageLimit}{\#Neighbors} \quad (3.1)$$

Therefore, from a macroscopic viewpoint, DCC can be viewed to decentrally allocate the share of the total channel resource. As shown in Figure 3.4, if there are 5 nodes in the channel, after reserving 40% channel capacity, the rest is equally shared among neighboring nodes by inter-vehicle resource allocation. However, the default fairness criteria is that neighboring nodes should have equal channel resource to transmit their periodic packets. However, as analyzed in later sections, this can have important consequence when the transmission requirements and resource demand from each node is not homogeneous.

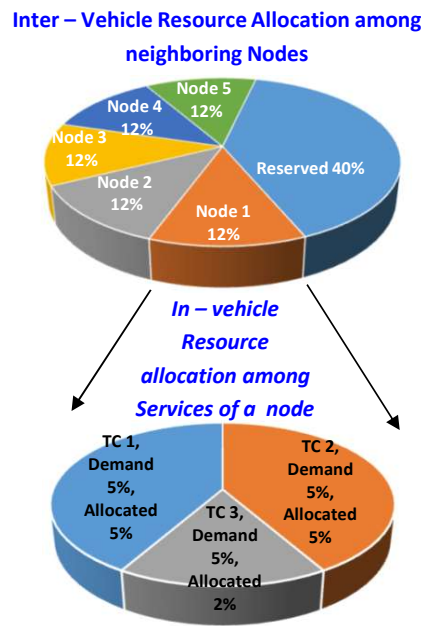

Figure 3.4: Conceptual representation of In Vehicle and Inter Vehicle Resource Allocation

3.4 In-Vehicle Transmit Rate Control

IVTRC has two roles: i) control the channel utilization of the node to respect the channel usage limit calculated by DCC, ii) distribute the node's total channel resource among the competing services inside the node. As mentioned in Section 2.2.3, messages in the ETSI ITS stack are generated by services, and not by applications themselves. Thereby, the transmit rate limit and channel resource allocation are calculated per service or per Traffic Class and not per application.

The second role of IVTRC is shown by the lower part of Figure 3.4. In this regard, the services need to be classified at different layers of the communication stack for priority based transmit opportunity allocation. As shown conceptually in Figure 3.4, the two higher priorities TC 1 and 2, get their demand, while the left over is allocated to TC 3.

3.4.1 Classifying Services for limited channel resource Attribution

In the ETSI standards and the C2C-CC implementation profiles, the QoS for each service and its packets are managed at different layers by different functionalities having different terminologies for packet prioritization, namely DCC-Profile, Traffic Class and Access Category.

DCC profile (DP):

DCC profile specifies a set of transmission parameters, managed in the cross-layer DCC management entity, for the identification and control of DCC parameters such as transmit rate, transmit power, DCC queue number, for packets from a particular

Table 3.1: Traffic classes for ITS-G5, source[8]

Traffic Class	Access Category	Channel	Maximum Tx Power (dBm)	MCS	Intended Use
0	AC_VO	CCH	33	6 Mbps	High-priority DENM
1	AC_VI	CCH	23	6 Mbps	DENM
2	AC_BE	CCH	23	6 Mbps	CAM
3	AC_BK	CCH	23	6 Mbps	Multihop DENM, other data traffic

service (like Cooperative Awareness, Collective Perception etc). These parameters are used for the purpose of DCC functionality, to enable traffic discrimination and prioritization of traffic of one service over another, at different layers of the protocol stack. For example for a given channel load, the Access layer TRC allows higher transmit rate to a more important DP and vice versa.

Similarly, the service layer packet generation entity follows the rate limit via a table lookup as a function of the channel load, set by the DP for that service, as discussed in Section 3.4.3. There are 32 DPs, out of which 8 have been defined and the rest are for future use cases. These 8 DPs are mapped into 4 Traffic Classes at the Network and Transport layers and 4 Access Categories at the Access layer. The lower the value of the DP, the higher is the priority. DCC Profile is specified in the ETSI standard [104].

Traffic Class (TC):

The TC provides a way to prioritize between data traffic at the Network and Transport layers, to provide different levels of QoS to each service required by the Facilities layer. Traffic Classification is not tightly coupled with the DCC functionality, i.e. it exists by itself to provide QoS functionality even without DCC. However, when DCC is used, the implementation profile (such as provided by C2C-CC [7]) provides the mapping between DCC Profile and Traffic Class, as shown in Table 3.1.

TC 0 has the highest priority, and is reserved for high priority DENM, followed by TC 1 for normal DENM. TC 2 is for CAM and most other messages, while re-forwarded multi-hop messages are sent using TC 3. The priority of CPM has not been decided, but is expected to be the same as CAM or lower. Thus, the lower the TC, the higher is the message priority.

TCs are managed by the GeoNetworking Media Independent functionality, and if the Access layer is ITS-G5, there are 4 TCs with values 0 to 3, mapped by GeoNetworking Media Dependent functionality, into one of the four medium access control (MAC) queues of ITS-G5.

Access Category (AC):

The classification at the MAC layer of ITS-G5 is termed as Access Category (AC), which in fact originates from IEEE 802.11e-2005 and has been incorporated into IEEE 802.11 MAC standards. It implements QoS via 4 such ACs, i.e. Voice, Video, Best Effort and Background, each having its own queue, implementing different waiting period before transmitting a packet, called Clear Channel Assessment (CCA). The waiting period consists of Arbitration inter-frame space (AIFS) and contention window (CW). As shown in Table 3.2, a higher priority AC gets lower waiting time and vice-versa.

Table 3.2: ITS-G5 Access Categories

Access Category	CWmin	CWmax	AIFS
AC_VO	3	7	58 μ s
AC_VI	7	15	71 μ s
AC_BE	15	1023	110 μ s
AC_BK	15	1023	149 μ s

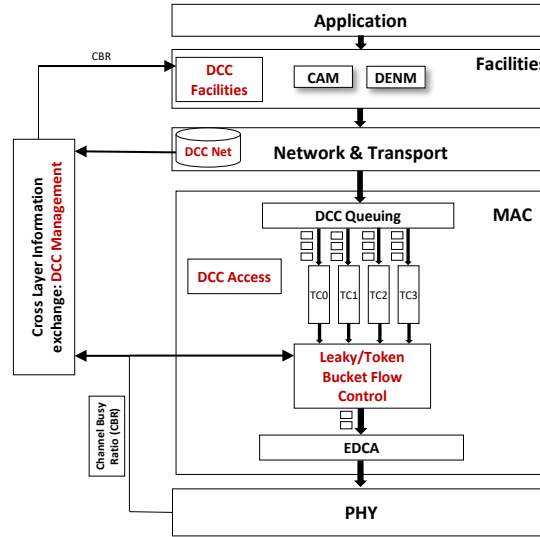

Figure 3.5: Congestion Control Stack Diagram

3.4.2 Access Layer Rate Control

In European standards, Transmit Rate Control (TRC) has been the most significant channel congestion control mechanism, where each node decentrally monitors the channel load and controls its transmit rate. One of the mechanisms of transmit rate control is via traffic shaping at the Access layer, while the other being packet generation control at the Service layer.

3.4.2.1 Channel Load Measurement

The Channel Load (CL) is measured as the Channel Busy Ratio (CBR), which is calculated as the proportion of time the channel is sensed busy. The node senses the channel every 8μ s and considers it busy if the detect energy is above Carrier Sense Threshold for example -92 dBm. The CBR is the ratio of the number of samples found busy over 12500 total samples of 8μ s duration, during the observation window of 100ms, according to:

$$CBR_{measured} = \frac{Samples_{busy}}{Samples_{per_cycle}} \quad (3.2)$$

The measured CBR is smoothed using a FIR first order 50% filter, to avoid overreaction to rapid channel load variation and prevent oscillations during fluctuating channel load, expressed as:

$$CBR_t = a * CBR_{measured} + b * CBR_{t-1} \quad (3.3)$$

Nodes can share their local channel load measurement with their 1-hop neighbors, by piggy-backing the local measurements inside the GeoNetworking header of transmitted CAMs, and a node can consider the highest channel load value in its vicinity. The geographic distribution of channel load can be variable, for example an intersection with more vehicles can have higher channel load than roads approaching the intersection. Therefore, vehicles on the approaching roads, whose transmissions may reach the intersection, but they themselves cannot measure the higher channel load of the intersection due to attenuation of received signal energy, would consider the channel load measurement piggybacked inside transmissions by vehicles who are already at the intersection.

The output of the Transmit Rate Control algorithm is the minimum time between two transmissions, *Toff* period, which can be calculated either using a Reactive mechanism via Table Lookup or Adaptive mechanism, as defined in the ETSI standard TS 102 687 [5]. The *Toff* period is used to limit the maximum transmit rate for each node, via Traffic Shaping at the Access layer.

3.4.2.2 Queuing & Flow Control

Traffic shaping consists of Queueing and Flow Control, as shown in Fig 3.5. It uses Absolute Priority LIFO mechanism for queuing, and Leaky Bucket for flow control of lower priority messages such as CAM, while token bucket for higher priority messages such as high priority DENM.

Each message (except emergency ones) is enqueued in one of the 4 DCC queues based on its Access Category. The queues are an extra layer of queuing above the MAC layer EDCA queues. Below the DCC queues, there is a flow control entity, also known by the term ‘**Gate-Keeper**’ in the literature. After transmitting each packet, the ‘Gate-Keeper’ prevents any transmission during a mandatory period known as *Toff*.

When the *Toff* period is over, the next message from the highest priority queue is dequeued and released into the MAC layer EDCA queues, followed by the ‘Gate-Keeper’ preventing a transmission during another *Toff* period. The duration of the *Toff* period determines the maximum transmit rate of the node. If a packet stays in the DCC queues for a duration of its Time to Live period (usually 1 second, lifetime of SHB packet [9, 101]), it is discarded. Similarly, if a queue of any Access Category is full, packets are discarded in a head-drop order, as safety messages for Day 1 deployment are broadcast and do not belong to a packet stream, so the goal is to transmit the message containing the latest information. However, in real implementations the queue size is generally 1, to allow the latest safety message to erase an older message waiting in the queue and itself be transmitted, while the older message gets discarded. Thus, when the queue size is 1, LIFO or head-drop strategies are irrelevant. The consequence of this issue is analyzed in Chapter 4.

From a queuing theory viewpoint, transmit rate control can be considered as a single server serving four queues of limited size. The queue arrival rate depends on the packet triggering condition of each service such as Cooperative Awareness or Collective Perception depending on vehicle dynamics and external conditions, and arrival of packets to be re-forwarded in case of multi-hop forwarding. The queue arrival rate can also be controlled by the Service/Facilities layer packet generation control, as explained in Section 3.4.3. Similarly, the queue service rate is determined by the congestion control algorithm as a function of the channel load. Therefore,

Table 3.3: Rate Control Parameters suggested by Reactive Access DCC of ETSI [5]. The EU commission’s Delegated Act[9], specifies the T_{off} values for 500 μ s packet air time, regardless of the packet size.

State	CBR	Packet rate (packet airtime 500 μ s)	Toff (airtime 500 μ s)	Packet rate (packet airtime 1000 μ s)	Toff (airtime 1000 μ s)
Relaxed	<30 %	20 Hz	50 ms	10 Hz	100 ms
Active 1	30 % to 39 %	10 Hz	100 ms	5 Hz	200 ms
Active 2	40 % to 49 %	5 Hz	200 ms	2,5 Hz	400 ms
Active 3	50 % to 65 %	4 Hz	250 ms	2 Hz	500 ms
Restrictive	>65 %	1 Hz	1 000 ms	1 Hz	1 000 ms

TRC controls the queue arrival rate by controlling the packet generation at the Service/Facilities layer and the queue service rate via the Reactive or Adaptive Access layer Rate control, as explained below.

3.4.2.3 Reactive Transmit Rate Control:

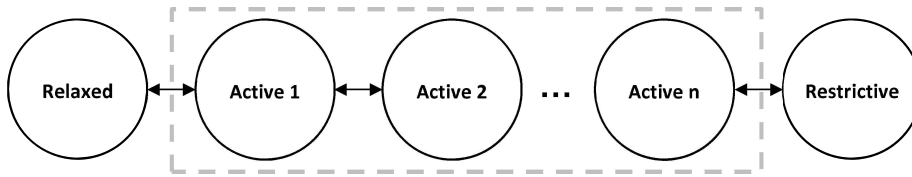

Figure 3.6: Reactive Transmit Rate Control State Machine, Image Source [5]

The Channel Load is sampled every 100ms, and T_{off} values for the corresponding CL are obtained via a table lookup, such as in Table 2.5, as indicated in the specifications of C2C-CC [101], and Table 3.3 as indicated by ETSI [10]. In Table 3.3, for a maximum packet size of 500 μ s, the highest Tx rate is 20 Hz for a CL < 30% when DCC is in Relaxed state, while the lowest rate is 1 Hz for CL > 65%, corresponding to a Restricted DCC state.

The Reactive TRC works as a state machine, as shown in Fig 3.6, and each range of CL maps to a Transmit Rate Limit, which corresponds to a state. Similarly, transition is only possible between one state and another adjacent to it.

In the initial design of Reactive TRC [10], transition was possible from one state to any other state. Additionally, in order to ensure system stability and to avoid rate oscillation a hysteresis was applied to the change of state. If the transmit rate is sampled at time T_0 , it was increased only if the CL was persistently lower than the load at T_0 during the following 5 seconds. However, while decreasing the transmit rate, the hysteresis duration was only 1 second, thereby preferring rapid adaptations for rate decrease rather than rate increase. However, this hysteresis creates problems of oscillations and creates instability, as shown in [35], and also discussed in the Results chapter of this thesis. Subsequently the hysteresis has been removed from the DCC design in the latest version of the ETSI standard [5], and the current state change corresponds to Fig 3.6.

3.4.2.4 Adaptive Transmit Rate Control/ Channel Resource Limit Control:

Adaptive Rate Control is another variant for Access layer transmit rate control, whose control process w.r.t CBR is based on the LIMERIC algorithm [51], as discussed in Section 2.4.1.2. It is specified in ETSI TS 102 687 as:

$$\delta(t) = \begin{cases} (1 - \alpha) \times \delta(t - 1) + \min(\beta \times (CBR_{target} - CBR(t - 1)), 0.0005) & CBR_{target} > CBR(t - 1) \\ (1 - \alpha) \times \delta(t - 1) + \max(\beta \times (CBR_{target} - CBR(t - 1)), -0.00025) & CBR_{target} \leq CBR(t - 1) \end{cases} \quad (3.4)$$

Unlike the Reactive mechanism, Adaptive rate control does not set the Transmit Rate Limit w.r.t channel load. Instead, it sets the Channel Resource Limit (CRL) or δ for the node, per unit of time. In the equation, the δ at time t , is a function of the last δ at the last measurement, (multiplied by a memory level α), added to the difference between the current CBR and the target CBR, multiplied by a weight β . It iteratively changes the CRL, with a goal to converge the CBR towards a target. Furthermore, in order to avoid sudden oscillation, the amount of increase or decrease in each iteration is bounded to 0.05% increase in δ , if the CBR is below the threshold of CBR_{target} , and 0.025% decrease in δ when the measured CBR is equal or above the threshold.

The δ or CRL is a unitless value, which can be expressed as the maximum fraction of time a node is allowed to transmit on the channel.

$$CRL_{Node} = \frac{T_{onNode}}{T_{onNode} + T_{offNode}} \quad (3.5)$$

The Adaptive transmit rate control can be rather considered as CRL Control, which is not called as such in the standard, but this terminology can distinguish it from the Transmit Rate Control. A distinction between the two terminologies is necessary, because the CRL sets the transmit rate as a continuous function of the packet airtime T_{on} , according to the above equation, whereas there is no continuous function relating the TRL to the packet airtime for Reactive TRC. The CRL gives each node the flexibility to adapt its packet size or airtime T_{on} . As a consequence, a node may transmit many small packets or few larger ones by remaining within the allocated CRL (i.e. the control algorithm does not directly limit the transmit rate). Regarding TRL, the standard provides two rate tables for packet airtime of maximum 0.5ms and 1ms, but a lack of continuous relation between the transmit rate and packet airtime has implications as discussed in Section 3.6.6.

The second difference between the two approaches is that the Adaptive algorithm determines the CRL w.r.t Channel Load using a continuous function, a variant of the LIMERIC algorithm [51], whereas the Reactive rate control maps the channel load to transmit rate limit via table lookup, resulting a step function.

3.4.2.5 Transmit Rate Control for Emergency Messages:

Emergency Messages such as high priority DENM for use cases such as Emergency Brake Light Warning or Pre-Crash Warning having the highest traffic class can bypass the DCC queues and the leaky bucket flow control. In that case the transmit rate is controlled using a **token bucket** flow control, with a token accumulation rate of 20 tokens per second, with an allocation of 20 tokens per 10 second, as

Table 3.4: Rate Limits for different ETSI DCC Profiles, as specified in [104]

DCC Profile DP	CCH DCC State Relaxed	CCH DCC State Active	CCH DCC State Restrictive
DPO	$T_{off} \geq 50$ ms	$T_{off} \geq 50$ ms	$T_{off} \geq 50$ ms
DP1	$T_{off} \geq 95$ ms	$T_{off} \geq 190$ ms	$T_{off} \geq 250$ ms
DP2	$T_{off} \geq 95$ ms	$T_{off} \geq 190$ ms	$T_{off} \geq 250$ ms
DP 3	$T_{off} \geq 250$ ms	$T_{off} \geq 500$ ms	$T_{off} \geq 1000$ ms

specified in the European Commission Delegated Act [9] and C2C-CC profile [101]. In other words, a node can transmit a burst of TC 0 packets at a maximum rate of 20 messages per second, with a maximum burst duration of 1 second, and only one such burst allowed every 10 second. However, it can be insufficient at times and degrading performance of critical safety applications as discussed in Section 3.6.6.5.

3.4.3 Service/Facilities Layer Rate Control

A limitation with Transmit Rate Control or flow control at the Access layer without coordination with the packet generation functionality is that applications might generate excess packets, which would queue up and age in the DCC queues, causing old packets being transmitted or dropped after a TTL. Therefore, influencing the generation of packets at the application layer allows to control applications to generate packets according to the channel load and prevent generating excess packets containing old information.

3.4.3.1 Service Layer Packet Generation Control via Transmit Rate Limit

In order to coordinate the rate of packet generation with the Access layer Transmit Rate Limit, the trigger mechanism of messages such as CAM or CPM depends on the contextual input such as a change in vehicle dynamics or object detection, and the Transmit Rate Limit for the corresponding ETSI DCC Profile [104], as shown in Table 3.4.

Taking the example of CAM Triggering [3], the parameter T_{GenCam_DCC} respects the DCC profile of rate limit of CAM, DP2 according to [104], depending on the DCC State, i.e. Relaxed, Active or Restrictive. As stated earlier in Section 3.4.2.3, Reactive TRC works as a state machine, where the current state of the Reactive TRC depends on the channel load.

Although the ETSI DCC Profile specifies different T_{off} values for Access layer Rate control and Service layer Packet Generation Control and different T_{off} values for different DP, the specification by C2C-CC [7], specifies the same values for Access and Service layers and for DP 1, 2 and 3. The rate limits given in C2C-CC specifications are shown in Table 2.5.

3.4.3.2 Service Layer Packet Generation Control via Channel Resource Limit

Another method of packet generation control at the ETSI service layer is via Channel Resource Limit, which is currently being drafted as ETSI TS 103 141 [30]¹. It operates at the Facilities Layer [39] below the Application Layer, to control the packet generation by each service.

It sub-divides the total CRL for the node to individual CRL for each service, as shown in Eq. 3.6, prioritizing allocation to each service using its traffic class (TC). If the channel usage demand of a higher priority service is satisfied, the remaining channel usage quota is allocated to the next priority level and so on.

$$CRL_{Node} = \frac{T_{onNode}}{T_{onNode} + T_{offNode}} = \frac{T_{on,app1}}{T_{on,app1} + T_{off,app1}} + \dots \frac{T_{on,appN}}{T_{on,appN} + T_{off,appN}} \quad (3.6)$$

The allocated CRL to a service is translated to packet generation limits for that service as a function of the packet size or packet airtime. After generating a packet of airtime such as $T_{on,app\ n}$, the packet generation control allows it to generate the next packet only if the corresponding non-generation period $T_{off,app\ n}$ of that service has passed, to restrain it within its allocated CRL. PGC via CRL does not involve queuing or dropping packets. It only delays allocating packet generation approval to a service using the parameter $T_{off,app\ n}$.

3.5 Challenges of Inter Vehicle Transmit Rate Control

3.5.1 Asymmetric Resource demand by heterogeneous Nodes

Transmit Rate Control, whether Reactive or Adaptive, attempts to ensure fair transmit opportunity allocation among neighboring nodes experiencing similar level of channel load, as discussed in Section 3.3.1. This could suffice for a Day 1 deployment scenario, where the nodes will transmit mostly a single type of message in the channel i.e. CAM/BSM, and occasionally DENM. However, as stated earlier, in future scenarios, vehicles will have a many more sensors, communication needs, applications and services, transmitting a variety of packets in the channel. Similarly, some vehicles will be more autonomous or ‘advanced’ than other legacy vehicles, and the number of services in each vehicle will not be uniform.

Consequently, vehicles having more number of services would require more channel resource, for example vehicles without object detection capability may not emit CPM, whereas may benefit from received CPMs. Therefore, a channel congestion control mechanism allocating similar transmit rates or channel resource to both legacy human-driven and more advanced vehicles, will not suffice for a Day 2 deployment scenario.

¹Available as a draft at the time of writing

3.5.2 Distributed Asymmetric Resource Allocation

As mentioned earlier, there is no centralized channel resource allocator in DSRC/ITS-G5 based V2X communication and, neither there is any exchange of network control and management traffic with regards to channel resource allocation, (apart from exchange of CBR measurements via piggybacking). One method of approaching this decentralized network resource allocation problem can be analogous to a real-life road traffic scenario of pulling out of the road by normal vehicles to make way for emergency vehicles (such as ambulance or fire-truck) on the road, to facilitate its passage.

Using this analogy, a node which is facing resource scarcity to transmit its higher priority messages can announce about its shortage, to the neighboring nodes within 1 hop distance sharing the channel. Thereby each neighboring node can equally sacrifice some share of its own eligible channel resource quota, which it is using to transmit lower priority messages, to make room for the higher priority communication of the node facing the shortage. Similarly, the beneficiary should be aware of this sacrifice and utilize the vacated channel capacity, while remaining within the congestion control limit. This method of solving the problem has been explained in the Chapter 4, Section 4.7 along with simulation based evaluation results.

3.6 Challenges of In Vehicle Transmit Rate Control

3.6.1 Limitations of Priority Queuing:

Absolute priority queuing may indefinitely starve packets in a low priority queue during channel congestion. A higher TC enjoys absolute priority over a lower TC, and a lower TC is not served unless the demand of a higher TC is fully met. This is problematic during resource shortage, that is, sum of the transmit rate or channel usage demand of all the services is greater than the TRL or the CRL for the node. In such a case, only applications having higher TC will be served and applications of lower TC will be starved. This is an inherent problem of simple priority based systems such as priority based queuing. Chapter 4 Section 4.3.5 demonstrates results regarding this issue.

3.6.2 Limitations of Traffic Class and Access Category

Firstly there are only 4 TCs 0-3, which are mapped into 4 ACs, which may not be enough as the number of safety services for DAY 2 scenario will be much more than four. Packets from different services belonging to the same Traffic Class cannot be differentiated and provided different QoS. For example, if TC 0 is reserved for High Priority DENMs and TC 1 for normal DENMs, while TC3 for lower priority re-forwarded packets, then TC 2 may have to be shared by CAM, CPM and MCM.

Following the same logic, at the Access layer DCC queues there is no notion of service or application, but only Access Category (AC). QoS can be provided only for the AC but not for each service. If CAMs and CPMs belong to the same AC, they will be queued in the same DCC queue and per service QoS cannot be provided

at the Access layer. Moreover, according to application design principles, each service always belongs to the same static Traffic Class and there is no mechanism to upgrade a lower priority service which can be starved persistently due to priority queuing at the Access layer during channel congestion, as mentioned before.

Similarly, the Service layer PGC via CRL gives absolute priority of one TC over another, replicating the same problem of starvation at the Facilities layer as well. Whereas the Facilities layer has access to information about each application, the node's context and environment, which can be used to dynamically allocate CRL for each service, instead of static Traffic Class.

Therefore, the principle of the 4 static TCs, originally designed for end user multimedia QoS, may not be sufficient for safety applications communicating in a dynamic cyber-physical context of Machine to Machine V2X communication, where the urgency of a service's packet can vary depending on the context. These issues have been further discussed in Chapter 4, along with results and analysis.

3.6.3 Limitations of Access DCC Queuing Policy & Queue Size

The Access layer DCC queue size as shown in Figure 3.5 is limited, and is usually set to 1 depending on the implementation, in order to allow a newer message, such as CAM containing more recent information to erase a CAM already waiting in the DCC queue. The reasoning behind this design is to transmit inside each messages, the most recent information available instead of transmitting older information. However, it works as long as there is only a single service per Traffic Class or Access Category. If multiple services, such as CAM and CPM belong to the same Traffic Class, a CPM can easily erase a CAM already in the queue and vice versa, causing management issues and performance degradation.

To mitigate this problem of erasing packets, if the queue size is more than 1, and a Last In First Out (LIFO) queuing strategy is followed with each packet having a limited TTL, then a service generating more packets may monopolize the channel. Thus packets from another service of the same TC may repeatedly get pushed away to the back of the queue and repeatedly be dropped after the TTL.

Whereas if a First In First Out (FIFO) strategy is used with a queue size greater than 1, then packets containing older information will get transmitted. Chapter 4, Section 4.4 further analyzes these issues using simulation based evaluation results.

3.6.4 Limitations of Channel Load Measurement

The channel load is measured as CBR, which is a ratio of the number of slots with a certain energy level over the total number of slots during an observation window of 100ms. However, if two packets are transmitted concurrently and occupy the same slots resulting in collision, the channel will be measured busy only once for those two transmission and not twice. Therefore, CBR does not indicate the amount of collision in the channel.

Similarly, measuring simply the energy does not indicate the type of packet in the channel. Therefore, if the nodes want to use for example 2/3rd channel capacity for non-emergency packets and the rest 1/3rd for emergency packets, measuring simply the energy level does not indicate the type of packet causing the load, and

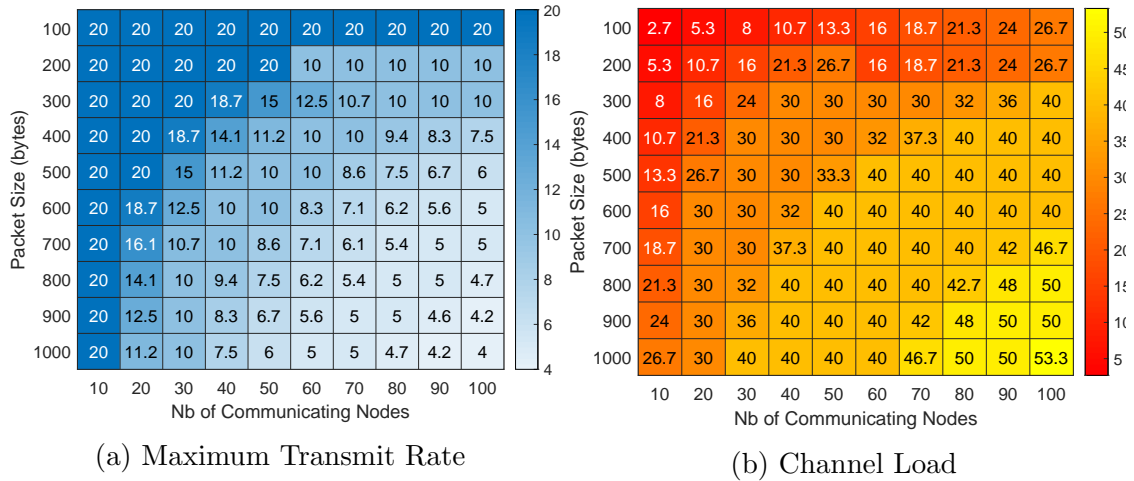

Figure 3.7: Theoretical Maximum Transmit Rate allowed by Reactive Access DCC for different combination of node density and packet size

as such channel capacity cannot be allocated for a specific type of communication. A mechanism has been described in Chapter 4 Section 4.7, to provide more resources to nodes transmitting higher priority packets. Chapter 5 further describes how the concept can be extended to reserving channel capacity for services based on priority.

3.6.5 Limitations of Reactive Transmit Rate Control

Figure 3.7a shows the theoretical maximum transmit rate allowed by the Access DCC to each node, for a combination of various packet sizes between 100 to 1000 Bytes (y-axis), and number of nodes sharing the channel (x-axis). Each box on the heat map represents the maximum transmit rate allowed to each node by the Reactive Transmit Rate Control, when an equilibrium is reached between the CL and the transmission rate, using the ETSI rate control parameters of Table 3.3 for $500\mu s$ packet air-time, which gives a maximum rate of 20 Hz and minimum of 1 Hz. Although Reactive TRC always oscillates between DCC states, as discussed in the next chapter, but considering the maximum of the oscillating transmit rate, we formulate the theoretical maximum transmit rate that the system can converge to as:

$$MaxTxRate = \max_{State i \in n} \left[\min \left(\frac{Max CL_{State i} * DataRate}{100 * NbofNode * PktSize}, MaxTxRate_{State i} \right) \right] \quad (3.7)$$

For a given pair of packet size and number of total nodes, each node iterates through each of DCC state i , and converges to the state which allows the maximum transmit rate allowed by that state or converges to the rate corresponding to the maximum channel load supported by the state.

Figure 3.7b shows the channel load for the corresponding transmit rate, for each combination of node density and packet size. For example, if 30 nodes share the channel, each transmitting 500 Bytes packets, the maximum transmit rate allowed will be 15 Hz per node. With a data rate of 6 Mbps, such a scenario will theoretically generate 30% CL, as shown in Figure 3.7b. Therefore, even if 70% channel capacity

is being unused, Reactive Rate control via table lookup will only allow a maximum transmit rate of 15 Hz, for all TCs of the node. This could be insufficient for a node having multiple services, such as 10 Hz CAM and 10 Hz CPM, whereas 70% of channel capacity is still unused.

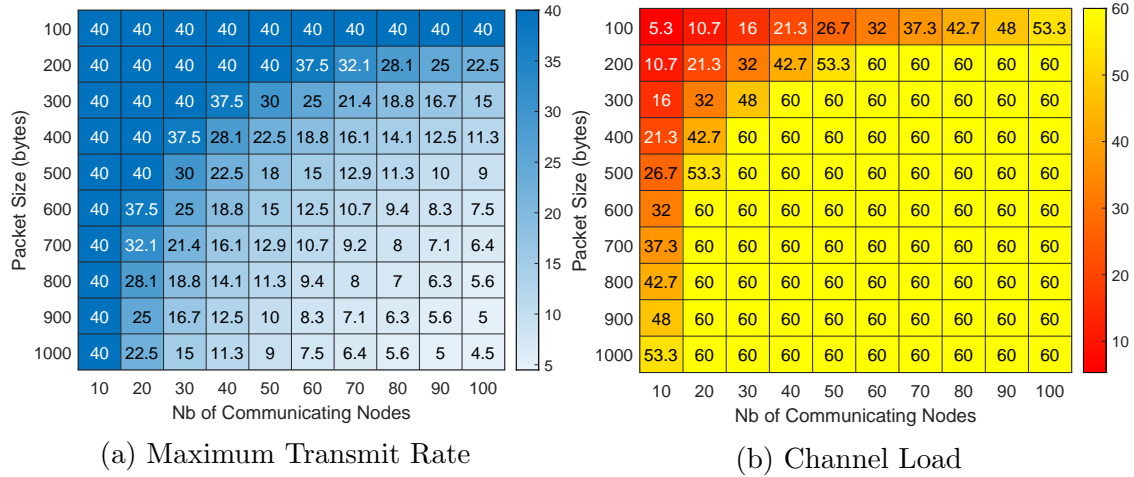

Figure 3.8: Theoretical Maximum Transmit Rate allowed by CRL control for different combination of node density and packet size for a Channel Load Limit of 60%

Figure 3.8a shows a similar theoretical transmit rate using the philosophy of Channel Resource Limit following Eq. 3.5, considering the same combination of packet size and number of nodes sharing the channel.

The overall channel usage limit is set to 60%, and is equally divided among the nodes following Eq. 3.1. The highest rate per node is limited to 40Hz as set in the standard ETSI EN 302 571 [105]. As shown in Fig. 3.8a, rate control via setting the channel resource limit per node, allows a minimum transmit rate of 4.5Hz and a maximum of 40Hz, almost twice or more compared to Reactive TRC. The gain can be explained via Figure 3.8b, as the rate allocation via CRL can fully utilize the available 60% channel capacity and distribute it among the nodes, without wasting channel capacity unlike Reactive TRC.

To summarize, Reactive TRC clearly wastes channel capacity, while limiting the transmit rate of each node. Moreover, the transmit rate is a step function w.r.t channel load, which wastes channel capacity. Similarly, unlike Adaptive TRC, the Reactive TRC does not provide a continuous relation between packet air time and transmit rate, which has implications as explained next. Chapter 4, Section 4.3 provides simulation results to demonstrate these facts, along with our proposed improvements to Reactive DCC which mitigate these issues.

3.6.6 Challenges of Cross-Layer Dependency

When the rate control functionality is spread across several layers, a lack of coordination among the different functionalities can degrade communication performance, which has been analyzed in this section.

3.6.6.1 Incompatibility between Access & Service Layer Rate Control

In addition to inefficient channel usage, Reactive TRC has compatibility issues in the ETSI multi-layered DCC architecture, including the Service layer packet generation control via channel resource limit.

Rate Control without considering packet size: As shown in Eq. 3.6, the PGC via CRL at the Facilities layer gives a node the flexibility to adapt its packet size and transmit rate. For example, considering a channel load $> 30\%$ and each node is allocated 1% of channel resource or duty cycle, it can transmit during 1ms followed by a pause of 99ms, thus transmitting at 10Hz. Similarly, it can transmit 20Hz packets from two applications, with airtime of 0.5ms per packet, still remaining within the allocated duty cycle.

However, when the transmit rate is controlled by Reactive TRC at the bottom, a 30% channel load will keep the DCC state in Active 1. This will not allow 20Hz transmission, as Reactive TRC only considers the *Toff* and does not consider the packet air time *Ton* in the C2C-CC rate control parameters of Table 2.5,3.3. Thus Reactive TRC does not permit the flexible resource allocation among the services of a node. It will block packets allowed by Facilities layer PGC via CRL, and thus will be in conflict with it. Although the latest version of ETSI DCC Access [5] proposes two rate control parameters for maximum packet sizes of $500\mu s$ and $1000\mu s$ as shown in Table 3.3, but the problem still prevails without a continuous mapping of packet size and transmit rate.

It might be assumed that a decrease in packet size could lead to an eventual reduction of the channel load, causing Reactive TRC to allow a higher transmit rate. However, to achieve that, a large number of nodes would need to reduce their packet size, which goes against the ‘Adaptability’ design goal of DCC, as discussed in Section 3.3. Moreover, each node may not have the same number of applications or the same packet size. Reactive TRC has been designed for Day 1 scenario, for each node transmitting a single type of packet, i.e. CAM, with the assumption that CAM sizes are similar across nodes. However, in a Day 2 scenario, the transmission requirements of nodes will be heterogeneous, requiring some agility and flexibility to be given to individual nodes, which is not permitted by Reactive TRC. Chapter 4 further discusses this issue and demonstrates performance improvements by implementing our proposed modifications to Reactive DCC.

3.6.6.2 Cross Layer Transmit Rate Control: Coordination between time parameters

The Access layer rate control involves a leaky-bucket, which allows transmission of the next packet after a waiting time *Toff*. There can be timers of packet generation processes at other layers, and if the timers of the different layers are not well synchronized, it can cause packets to queue up at the Access layer DCC queues and packets containing old information be transmitted, as further demonstrated in Chapter 4 Section 4.5.

3.6.6.3 Coordination between rate control parameters at the same layer

As mentioned earlier, the generation of packets at the Service layer is controlled by trigger based on external inputs, such as change in motion or object detection, as well as Service layer rate control parameters such as T_GenCam_DCC or T_GenCpm_DCC , in order not to generate excess packets which would queue up in the DCC Access queues.

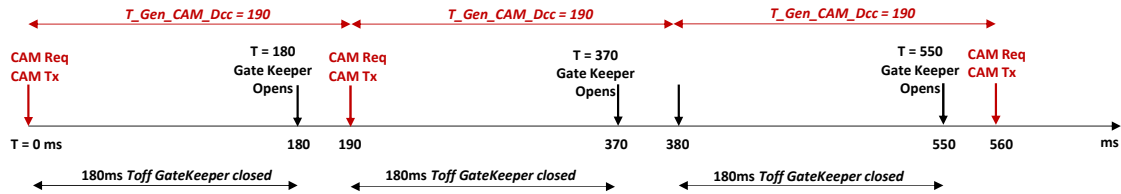

Figure 3.9: Coordination between Service and Access Layer Rate Control for single message

Figure 3.9 shows such an example of T_GenCam_DCC , considering DCC is state Active2, so $Toff$ is 180ms from Table 3.3 and T_GenCam_DCC is 190ms considering DP2 for CAM, as in Table 3.4. In the figure, whenever a CAM is generated, it is being transmitted, as the packet generation interval T_GenCam_DCC is higher than $Toff$.

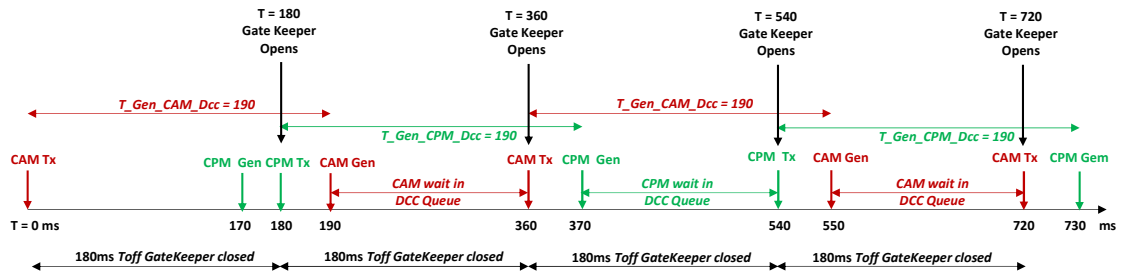

Figure 3.10: Coordination delay between Service and Access Layer Rate Control for multiple messages with same DCC Profile

In the same scenario, if the node has another service CPM with the same DCC Profile DP2, it will create a delay of 170 ms between the generation and transmission of both CAM and CPM, as shown in Figure 3.10. For example at 370 ms, when the T_GenCpm_DCC parameter will be over and the service will generate a CPM, it will wait in the DCC queue till the next Gate Keeper opening time, i.e. 540 ms as the previous instance when the Gate Keeper was open at 360 ms, the opportunity was used by CAM service, and without proper coordination, the CPM service may not be aware of that. Thus the sensor information inside CAM and CPM packets will be minimum 170 ms old, which will increase with higher channel loads in addition to CSMA channel access delay.

ETSI specifies different non-transmission periods $Toff$ i.e. obligatory pause between packet generation at the Service layer for different DCC Profiles, as shown in Table 3.4 (which is different from the Access layer $Toff$ values as shown in Table 3.3). However, in the C2C-CC specification [7], DP 1, 2 and 3 have the same $Toff$

values, as shown in Table 2.5. Therefore this scenario is more relevant following the C2C-CC implementation profile.

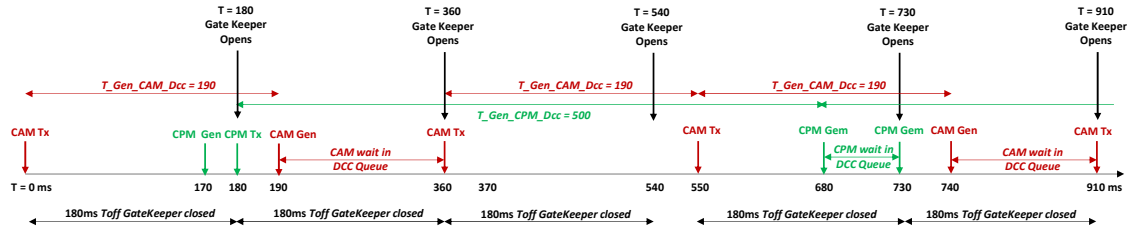

Figure 3.11: Coordination delay between Service and Access Layer Rate Control for multiple messages with different DCC Profile

Similarly, if CPM uses DP3, a DCC Profile lower and of less priority than CAM, the synchronization problem among the parameters still exists, as shown in Fig 3.11. In one second time window, 4 CAMs and 2 CPMs are transmitted. Even though the 1st and the 3rd CAMs are transmitted without any delay, the 2nd and the 4th CAMs get delayed by 170ms. On the contrary, the 1st CPM gets delayed by 10 ms while the 2nd by 50 ms. Thus even though CAM has a higher DP, the average delay of CAM in the DCC queue is $170 \times 2 \div 4 = 85$ ms, but only $(50 + 10) \div 2 = 30$ ms for lower priority CPM.

This lack of synchronization and the resulting delay can easily be avoided with proper coordination among the packet generation functionality of all the services w.r.t the next DCC Gate Keeper opening time. As discussed in Section 4.6 of the next chapter, a service layer resource orchestrator demonstrates how it can be best suited for this purpose.

3.6.6.4 Limitations of Leaky Bucket:

The use of leaky bucket for rate control has some limitations which have been discussed in this sub-section.

Enforcing Periodicity

Leaky bucket employs an obligatory *Toff* after every transmission at the Access layer Rate or CRL Control, which enforces rate control by making the transmissions periodic. Similarly, at the Service layer, although there is no queuing or flow control, but the packet generation control parameters T_GenCam_DCC or T_GenCpm_DCC and CRL control parameters $Toff_{app\ n}$, ensure constant interval between packet generation, thus enforcing periodicity. However, this could delay event-triggered packets such as DENM, occurring in a burst, as the rate control parameters are fixed without any flexibility required by the context.

Use it or Lose it

The channel load is updated every 100ms according to specifications of C2C-CC[101] and EU Delegated Act [9], but there is no consideration of fixed time window when allocating Service layer CRL. As mentioned in Section 3.4.2.4, the CRL is just a ratio of proportional non-transmission period *Toff*, after transmitting a packet of size *Ton*. If a service does not use up its allocated Channel Resource during a window of 100ms, it loses the resource, i.e. a pure leaky bucket does not allow

a service to accumulate tokens. However, the proposed Facilities layer resource orchestrator in the next chapter mitigates this problem.

Fire and Forget

When allocating channel resource to a service, the past allocation to the service is not considered, and the Service layer adopts a ‘Fire and Forget’ approach, i.e. prioritizing each service solely via Traffic Class and allocating the available CRL to a service of higher priority, without maintaining any allocation history. Similarly, if a lower priority service is starved successively of transmission opportunity, it is not allowed any opportunity after successive refusals, as the transmission history is not considered. In fact, there is no concrete concept of a Service layer scheduler or resource manager in the ETSI ITS stack. As mentioned earlier, in Chapter 4 we present a resource orchestrator at the Facilities layer.

3.6.6.5 Limitations of Token Bucket: Limited Burst size/Opportunity

According to C2C-CC implementation profile [101] and European Commission Delegated Act [9], packets belonging to the highest traffic class TC 0, such as high priority DENM emitted by applications such as Emergency Electronic Brake Light Warning or Pre-Crash Warning, can bypass the leaky bucket flow control and be emitted in a burst, controlled by a token bucket. However, as indicated in Section 3.4.2.5, the burst size is limited to 20 packets per burst, with a burst duration of 1 second and only 1 burst every 10 seconds. Therefore, as an emergency situation can usually persist beyond one second, and the application needs to emit DENM for a duration longer than 1 second, then it will be prevented DENM emission, seriously threatening road safety. In the next chapter, Section 4.7 we demonstrate a mechanism to allocate more resource to a node transmitting higher priority packets, which can remedy the problem of temporary burst allocation via token bucket.

3.7 Paradigm Shift: Innovation and Methodology

In this chapter we analyzed the problem of V2X channel congestion control, in particular transmit rate control, which can be treated either as a transmit rate control problem or as a question of channel resource limit control. Similarly, the problem of channel resource limit control can be analyzed as an issue of channel resource allocation, which in turn can be split into two parts, Inter-vehicle and In-vehicle resource allocation.

Inter-vehicle resource allocation allocates a limited amount of transmit resource to each vehicle per unit of time. However, existing rate control mechanisms allocate equal transmit resource to each vehicle, without considering the communication needs of each vehicle. Therefore there is need for a mechanism to allocate resources among the vehicles, proportionately according to the demand and priority.

In-vehicle resource allocation allocates the externally obtained resource among the services of a node. In this regard, transmit rate control at the Access layer is not sufficient to manage multiple services and a packet generation control mechanism is needed at the Facilities layer. However, we analyze that transmit rate control

decision taken at multiple layers of the ETSI ITS stack can be inefficient without proper coordination between the layers, resulting in lost transmit opportunities. The lifetime of the allocated resource or transmit opportunity is temporary. If the resource is not used within its lifetime due to lack of cross layer coordination, then the resource is lost.

Moreover, we also analyze that lack of coordination among the services can lead to inefficient usage of the limited transmit opportunity, in particular lack of synchronization leading to generating packets early and transmitting packets containing old information. Lastly, static Traffic Class or Access Category is not sufficient to categorize safety V2X services and more dynamic metrics are needed to prevent indefinite starvation of lower priority services during insufficient channel resource.

3.7.1 Need for an In-Vehicle Resource Orchestrator

Due to the limited knowledge and degree of freedom at the Access layer, along with static Access Category and limited QoS options, it leads to hard decisions accompanied by a lack of coordination between the V2X services. Therefore, instead of keeping the rate control intelligence at the Access layer or spreading it across different layers, we propose to shift the control intelligence to the Facilities layer via implementing a Resource Orchestrator. A multi-service Resource Orchestrator located at the Facilities layer would be capable of dealing with the aforementioned issues.

The design guideline of such an orchestrator should be:

1. Located at Facilities to allow a tight coordination between V2X services
2. Receive the transmit opportunities from the Access layer and orchestrate their usage between V2X services
3. Provide extended QoS levels to integrate application-level requirements of V2X services instead of static Traffic Class
4. Avoid starvation of lower priority V2X services through dynamic resource reallocation

It can function even without the Access layer ‘Gate-Keeper’ or coordinate with the Access layer ‘Gate-Keeper’ if there is one, as indicated in point 2 above. In the next chapter, we present results corresponding to the issues discussed in this chapter and demonstrate performance improvements using our proposed improvements. Similarly, we present the design of an orchestrator at the Facilities layer and demonstrate results proving the performance gain from having such a resource orchestrator in the protocol stack.

Chapter 4

Results and Analysis

4.1 Introduction

In this chapter we present the performance evaluation of the problems discussed in the last chapter and analyze the implications of those problems. Similarly, we propose better design and improved algorithms, along with the theoretical formulations, and simulation based evaluation highlighting the performance improvements via our proposed solutions.

The results in this chapter are grouped into the following 6 categories:

1. Transmit rate control efficiency of Access DCC
2. Queuing and traffic shaping of Access DCC
3. Cross layer coordination between Access and Facilities Layer Packet Generation Control (PGC)
4. Facilities Layer Resource Orchestration
5. Inter-vehicle distributed resource allocation asymmetrically to vehicles with higher requirements
6. Evaluation of ITS-G5 spectrum sharing with other technologies

For the ease of reading, we present the results and provide the analysis along with those results, having this single chapter for both results and analysis. Similarly, we use interchangeably the word “application” and “service”, for the sake of simplicity we don’t differentiate between the two terms.

4.2 Simulator & Simulation Scenario

In this section we present the simulator used for performance evaluation in this thesis, along with the scenario and settings used for the simulations.

4.2.1 iTetris-NS3 Network Simulator

Simulating cooperative vehicular communication and ITS systems require the capability to jointly model vehicular mobility, wireless vehicular communications, in

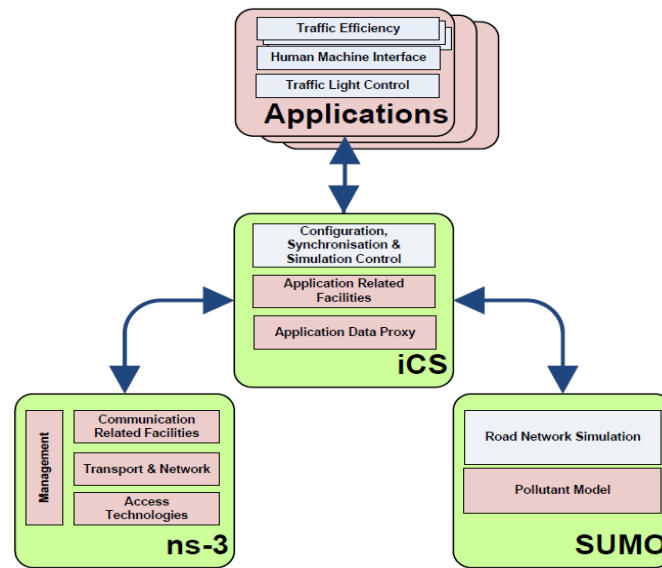

Figure 4.1: iTetris Network Simulator Architecture, Image source [6]

addition to implementing and executing novel cooperative ITS applications. We used iTETRIS simulator, (iTETRIS: an Integrated Wireless and Traffic Platform for Real-Time Road Traffic Management Solutions, ¹), which is an open source simulation platform for simulating cooperative ITS systems and services. The architecture of iTETRIS is depicted in Figure 4.1, containing three modules, i.e. the traffic simulator SUMO, an ETSI ITS compliant extension of the network simulator ns-3, and an ITS application module around a control module, the iCS.

iTetris uses NS-3 <http://www.nsnam.org/> as the network simulator. NS-3 is an open source discrete-event simulation environment that has been designed to be the successor of the popular simulator NS-2. NS-3 simulator has been enhanced for iTETRIS by implementing V2X-specific capabilities, according to the ETSI standard, which are briefly explained below:

- **Access Layer:** The ETSI ITS-G5 (IEEE 802.11p) has been integrated as another WLAN access technology, while a channel router module controls the multi-channel operation of NS-3 between three channels: CCH, SCH1 and SCH2. In this thesis, the CCH has been used for transmitting multiple Day 1 and Day 2 safety V2X messages.
- **Network Layer:** A dual stack (IPv6, ETSI ITS Geonetworking as defined in ETSI EN EN 302 636-4-1 [43]) is available. The V2X capable protocol stack ETSI ITS Geonetworking protocol stack includes geographic addressing capabilities, as well as multi-hop geographic routing.
- **Facilities Layer:** The facilities layer (as defined in ETSI TS 102 894-1 [39]) has been separated into two parts: the application facilities, implemented in the iCS, and the communication facilities implemented in NS-3. The latter are composed of three major blocks: the CAM/DENM/CPM message generators, the communication technology selector, as well as a DTN module.

For the evaluation in this thesis, protocols such as ETSI Access DCC, Gate

¹<http://ict-itetris.eu/>

Keeper, Cross Layer and Facilities DCC, ETSI CAM Generation, Resource Orchestration, Asymmetric Allocation per Node, Spectrum Sharing protocols etc. were implemented and simulated in iTetris. Similarly, existing protocols in iTetris were updated to conform with the latest ETSI standards.

4.2.2 Simulation Parameters

In this Section, we present simulation based evaluation results to analyze the issues of the ETSI standardized congestion control protocols, i.e. transmit rate control protocols and resource allocation presented in the last chapter. We propose new protocols and demonstrate the performance improvements using our proposed protocols.

A 4 lane by 4 lane bi-directional 10km sub-urban highway is simulated with vehicles moving between 70 to 90km/h following a Gauss-Markov mobility model, for various levels of vehicle density, between 10 to 50 vehicle/lane/km. The maximum vehicle density corresponds to Level of Service F of the USA highway capacity manual [106]. Each simulation has been run with a particular vehicle density.

Each node is equipped with ITS-G5 transmitters and the ETSI ITS stack. We use the iTETRIS simulator [6], which has a full ITS-G5 protocol stack implemented on top of NS-3, as described earlier. The wireless channel contains path-loss, shadowing and fading effects and is modeled according to Cheng and Stancil propagation model [107]. For this propagation model and 23dBm transmit power, each vehicle shares the channel at an average with 80 to 300 other vehicles, for a vehicle density between 10 to 50 vehicle/lane/km, as shown in Figure 4.2.

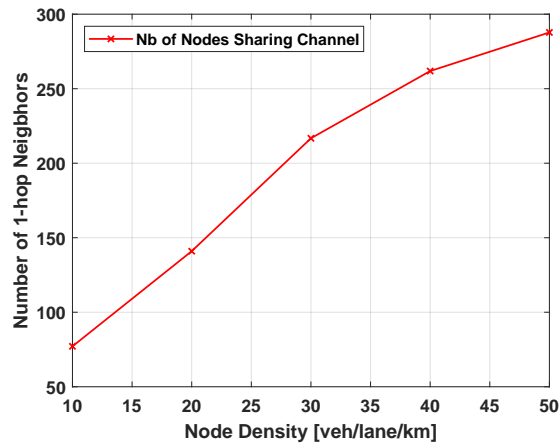

Figure 4.2: Number of Nodes sharing the channel for each simulation density

Each node has 3 safety applications CAM, DENM and CPM. CAM and CPM are active in all the evaluations, while DENM is activated in some of the evaluations where necessary. CAM are generated using the triggering conditions stated in ETSI EN 302 637-2 [3]. CPM are emitted at a uniform random rate of 1-10 Hz. The maximum and minimum rates have been proposed in ETSI TR 103 562 [108], while the exact CPM triggering conditions are still being standardized at the time of writing and not simulated here. Lastly, in some of the evaluations, 10% of the vehicles emit a single burst of 100 DENM, at a rate of 10Hz.

For the analysis and evaluation of this thesis, DENM are not forwarded and simulating exact DENM emission conditions i.e. detecting an accident or road hazard, are not primordial for the performance evaluation in this thesis. Nevertheless, DENM or any geonet packet forwarding can be treated just as another service generating network traffic and will be analyzed in future work. The DENM simulated in this thesis are normal DENM, which are managed by the DCC rate control, unlike very high priority DENM, which can bypass the DCC using a token bucket, as explained in chapter 3, section 3.4.2.5.

The performance is evaluated in terms of Requested vs Allowed Inter Transmit Time (ITT), Packet Inter Reception Time (IRT), Channel load and DCC Queue Delay. Table 4.1 summarizes the main simulation parameters.

Table 4.1: Simulation Parameters

Parameter	Value
Transmit Rate	CAM triggered, CPM 1-10 [Hz] DENM 10 [Hz]
Transmit Power	23 dBm
DataRate	6 Mbps
Packet Size	CAM 300 Bytes, CPM 650 Bytes DENM 400 Bytes
Packet Priority	DENM: (TC1), CAM (TC2), CPM (TC 2 and 3)
Mobility	Gauss Markov, 4 by 4 lane 10km highway, 10-50 veh/lane/km Speed: 70-90kmh
PHY and MAC	ITS-G5 802.11p in 5.9 GHz (10 MHz Control Channel)
Fading	Cheng and Stancil
Preamble DetectionThreshold	- 92 dBm
Performance Indicators	Queue Delay, Inter Transmit Time, Channel Load Avg 30 - 50 runs

4.3 Access Layer Transmit Rate Control

In this section, we present the performance of Access layer DCC, i.e. the Transmit Rate Control functionality of DCC². We present the performance without DCC, then the performance of several versions of ETSI DCC and demonstrate how the performance of ETSI Access DCC can be improved.

4.3.1 Performance Benchmark: No Congestion Control

Figure 4.3 shows the performance of CAM and CPM messages, when no DCC mechanism is activated. In Fig 4.3a and 4.3b, the y-axis shows the requested ITT and the IRT as milliseconds (ms), and the x-axis represents the vehicle density, ranging from 10 to 50 veh/lane/km. There are 3 curves for IRT for distances between 0-100m, 100-200m and 200-300m respectively. Figure 4.3c shows the Channel Load (CL) for each vehicle density.

As DCC is not activated, the requested CAM ITT of around 200ms and CPM ITT of 500ms is fully satisfied regardless of the node density. However as the node density or CL increases, the packet reception degrades denoted by an increase in the

²The terms DCC and TRC are used interchangeably, as only TRC has been analyzed in this thesis

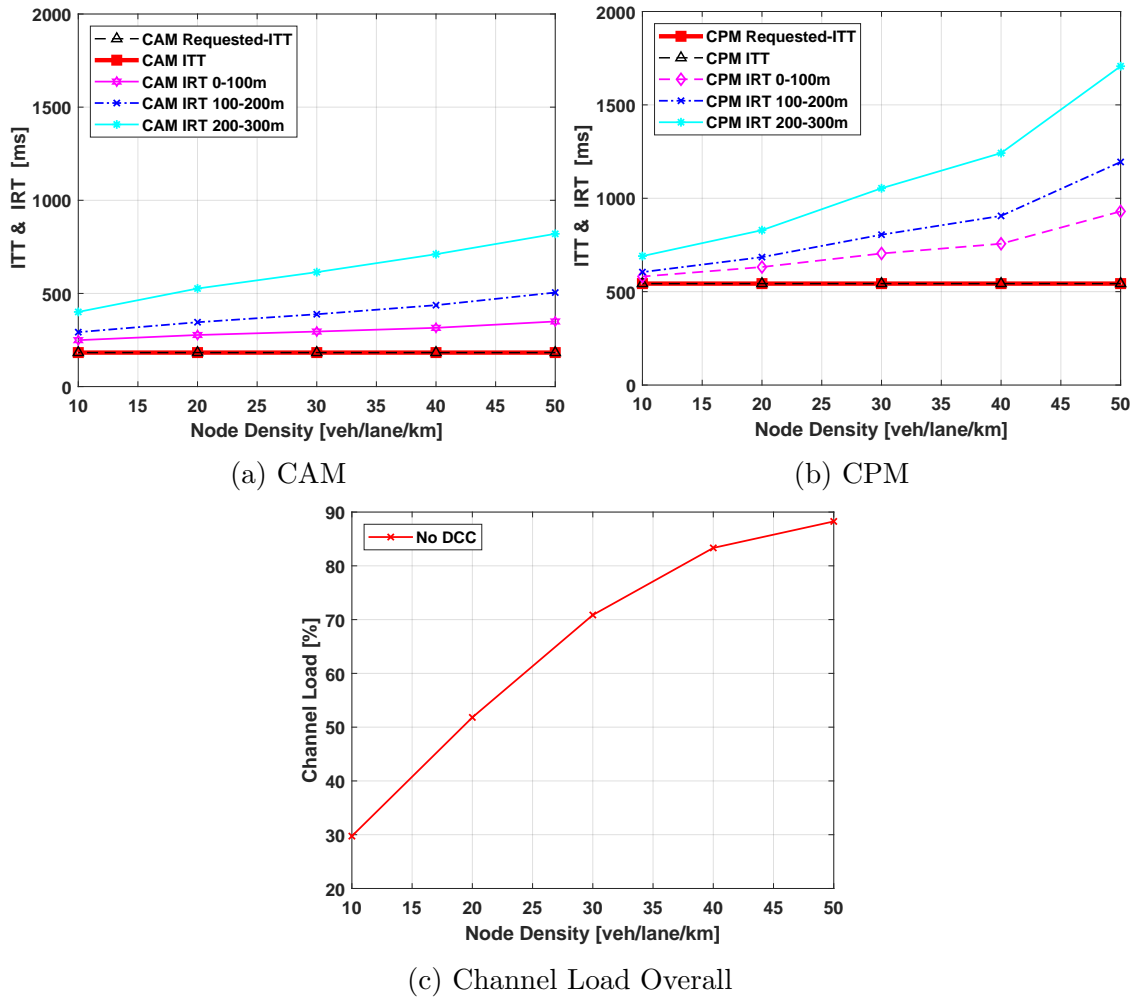

Figure 4.3: Application performance without DCC

IRT at higher distances. For the highest density of 50 veh/lane/km, the CL reaches 90%, as shown in Figure 4.3c. At that CL, for a CAM ITT of 200ms, the average CAM IRT are 400ms, 500ms and 800ms, at distance ranges of 0-100m, 100-200m and 200-300m respectively. CPM follows a similar performance degradation pattern. The degradation can be attributed to packet collision with hidden nodes, which deteriorates as the node density and CL increases. Therefore, this demonstrates the need for DCC, to limit the CL below threshold and improve packet reception performance.

4.3.2 Reactive DCC - Earlier Version

As discussed in earlier chapters, DCC is of two variants, i.e. Reactive and Adaptive. The Reactive DCC has been in ETSI standards since 2011, TS 102 687 V1.1.1 [10] and has been recently updated to TS 102 687 V1.2.1 [5]. However, we start by presenting the performance of Reactive DCC V1.1.1 to highlight the shortcomings of Reactive DCC.

Figure 4.4 shows the performance of CAM and CPM messages, when Reactive DCC V1.1.1 is activated in each node which performs worse compared to Figure

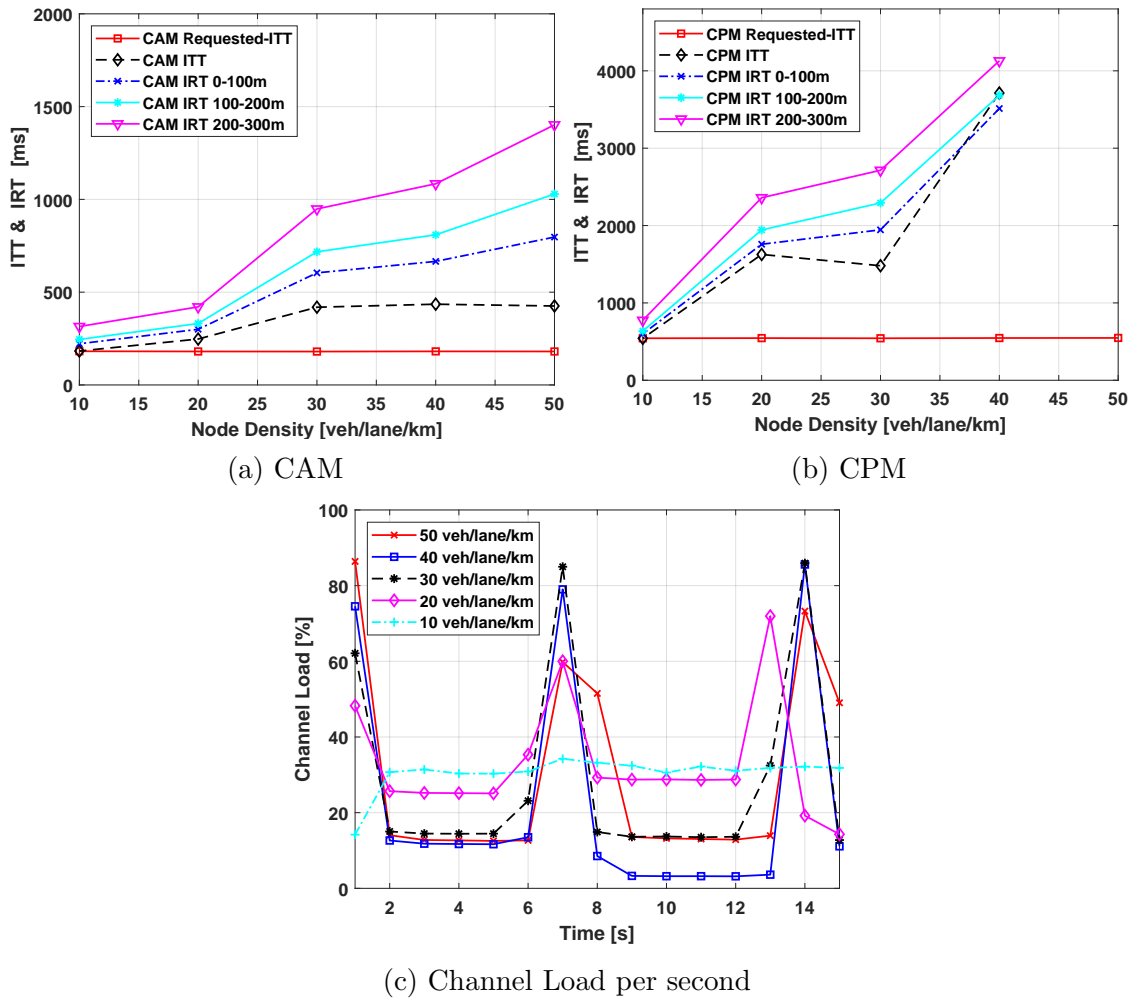

Figure 4.4: Application performance with old Reactive DCC (TS 102 687 V 1.1.1)

Table 4.2: Rate Control Parameters for Reactive DCC V1.1.1 [10]

State	Channel Load %	Toff (ms)	Tx Rate (Hz)
relaxed	$0\% \geq CL < 19\%$	60	16.7
active_1	$19\% \geq CL < 27\%$	100	10.0
active_2	$27\% \geq CL < 35\%$	180	5.6
active_3	$35\% \geq CL < 43\%$	260	3.8
active_4	$43\% \geq CL < 51\%$	340	2.9
active_5	$51\% \geq CL < 59\%$	420	2.4
restricted	$CL \geq 59\%$	460	2.2

4.3, i.e. having no DCC at all. There are two issues responsible for this. Firstly, the rate control is done via mapping the channel load to the transmit rate limit, according to the parameters of Table 4.2, which limits the transmit rate even at low CL of 20%, which can be overly aggressive.

The second major problem of Reactive DCC V1.1.1 is that for system stability and to avoid rate oscillation a hysteresis was specified in the standard to the rate change, as discussed in Chapter 3 Section 3.4.2.3. If the transmit rate is sampled at time T_0 , it is increased only if the CL is persistently lower than the load at T_0 during 5 consecutive seconds. However, while decreasing the transmit rate, this

hysteresis duration is only 1 second, thereby preferring rapid adaptations to rate decrease rather than increase.

The effect of the hysteresis can be observed in Figure 4.4c which shows the channel load for each node density, during a period of 15 seconds. When the CL is high, the DCC state jumps to Restrictive, which limits the transmit rate and decreases the CL. After 5 seconds of low CL, the state is relaxed, which suddenly allows a high transmit rate, and the cycle continues. The degrading effect of this phenomena is two-fold on the communication performance. During 5 seconds of restrictive state, the transmit rate is throttled which limits application performance. Secondly, after 5 seconds the limit is relaxed resulting in high number of simultaneous transmissions and collision, degrading packet reception performance.

Lastly, there is almost no CPM transmission for the highest node density of 50 veh/lane/km, as CPM has a lower priority than CAM and there aren't transmit opportunities (DCC-TxOp)³ left for CPM after CAM transmissions. This is because the available DCC-TxOp is monopolized by CAM, which has a higher priority in this scenario.

4.3.3 Reactive DCC - Latest Version

In this subsection, we analyze the latest version of Reactive Access DCC. In the latest version, the 1s and 5s hysteresis have been eliminated, and transition is possible only between adjacent states, which prevents the rapid fluctuation of transmit rate and channel load. Similarly, the rate limits are less severe than earlier, as indicated in Table 4.3⁴, compared to Table 2.5.

These two modifications have improved the communication performance, which can be seen in Figure 4.5a and 4.5b, where the IRT of CAM and CPM are between 100 to 200ms lower for every node density, compared to Figure 4.4. Similarly, the fluctuation of CL is less rapid, as shown in Figure 4.5c, resulting in an overall CL of 45%. In the next sub-section, we present our improvements to Reactive DCC.

4.3.4 Improving Reactive DCC

Although ETSI Reactive DCC in the standard V1.2.1 performs much better than V1.1.1, we consider utilizing the channel only till a capacity of 45% as an under utilization, and thereby propose three improvements to Reactive DCC, to improve its performance. Moreover, as discussed in Chapter 3 Section 3.6.6, there are compatibility issues between Reactive DCC and Facilities layer Packet Generation Control (PGC). Our proposed changes make Reactive DCC compatible for handling variable packet size and variable number of applications per node.

Modification 1: From Transmit Rate Limit to Channel Resource Limit

Reactive DCC maps the channel load to transmit rate limit without having a continuous relation to the packet size. We transform the transmit rate parameters of Table 4.3 into Table 4.4, using Equation 3.5, converting transmit rate control to Channel Resource Limit (CRL) control, as discussed in Chapter 3. For example,

³We call it DCC-TxOp to distinguish it from EDCA TxOp

⁴Table 4.3, is the same as Table 3.3, presented here again for the ease of readability

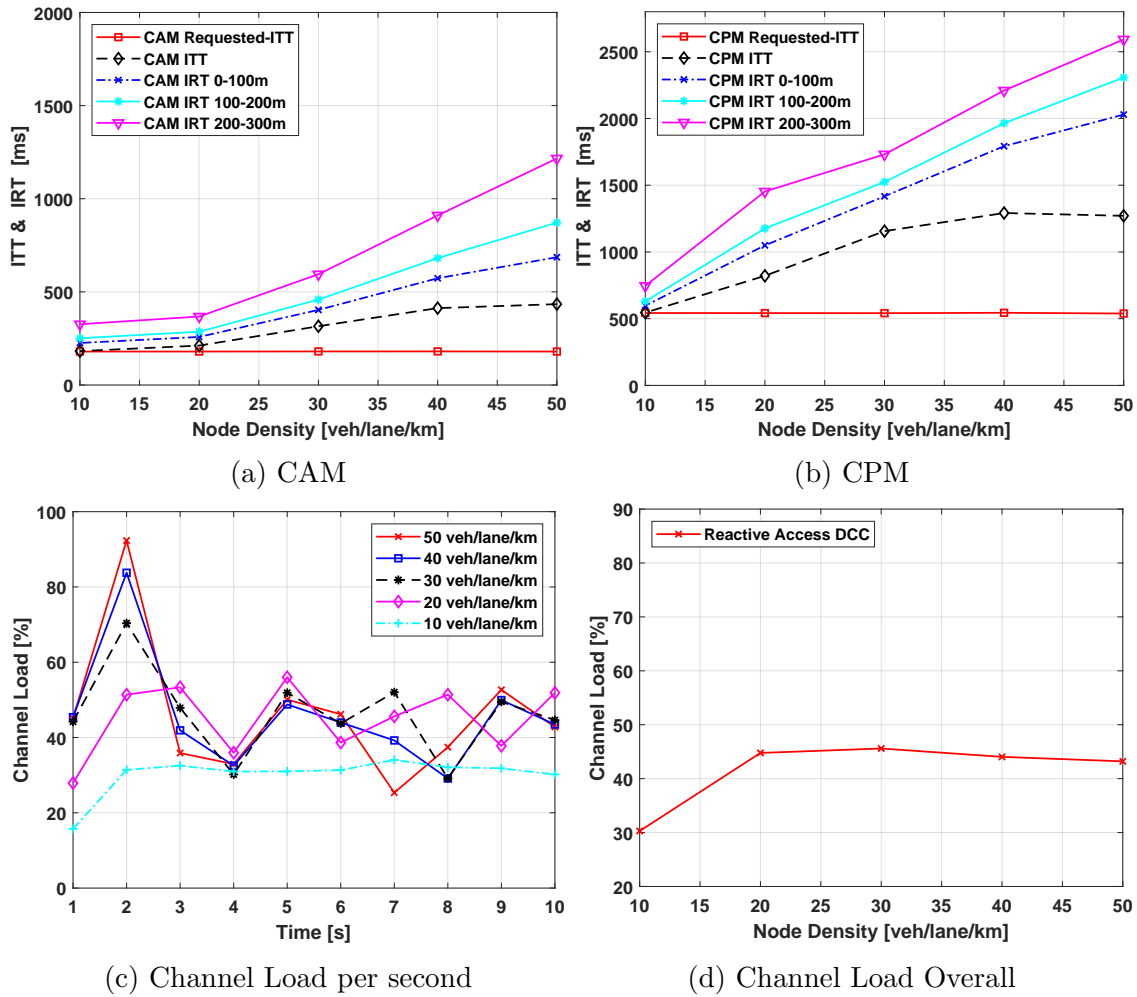

Figure 4.5: Application performance with Reactive DCC (TS 102 687 V 1.2.1)

State	CBR	Packet rate (packet airtime 500 μ s)	Toff (airtime 500 μ s)
Relaxed	<30 %	20 Hz	50 ms
Active 1	30 % to 39 %	10 Hz	100 ms
Active 2	40 % to 49 %	5 Hz	200 ms
Active 3	50 % to 65 %	4 Hz	250 ms
Restrictive	>65 %	1 Hz	1 000 ms

 Table 4.3: Transmit Rate Control
Parameters of ETSI Reactive DCC [5]

Channel Load	Channel Resource Limit (CRL) per Node
<30%	1%
<40%	0.50%
<50%	0.25%
<45%	0.20%
>=65%	0.05%

 Table 4.4: Our proposed
Channel Resource Limit
Control Parameters

as shown in Table 4.3, transmitting a 500 μ s (0.5ms) packet at 20Hz (50ms ITT) corresponds to 1% CRL, i.e. $0.5 \div 50 = 0.01$ or 1% CRL, as shown in Table 4.4.

Similarly, using CRL as the dimension of measurement, a node can transmit fewer big packets or more small packets, as long as the sum of all transmissions respect the CRL. Figure 4.6 shows the performance difference of using transmit rate versus channel resource control. In this scenario, one group of the vehicles emit 300 Byte CAM at 5Hz, whereas the other group requests to emit 150 Byte CAM at 5Hz and 150 Byte CPM at 2Hz. As shown in Figure 4.6a, the CAM demand

of the first group is satisfied and so of the second group. However, the CPM demand of the second group is not satisfied from a density of 30 veh/lane/km.

Even if the second group of nodes asks for a lesser number of Bytes per second, $150 * (5+2) = 1050$ Bytes/sec, compared to the first group, i.e. $300*5 = 1500$ Bytes/sec, the demand of the second group is not satisfied, as the transmit rate control considers only the requested transmit rate of 5Hz and 7Hz of the vehicles, without considering the reduction in packet size of the second group compared to the first group. When TR control is replaced by CRL control, the performance of both the groups of vehicles are similar, as shown in Figure 4.6b.

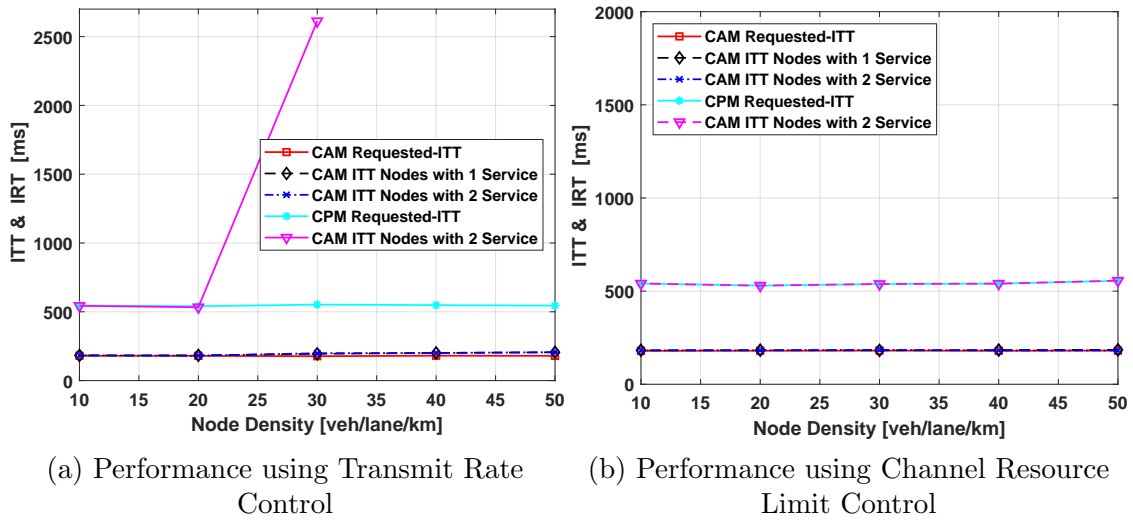

Figure 4.6: Application performance with Reactive DCC, One and Two Applications per Node

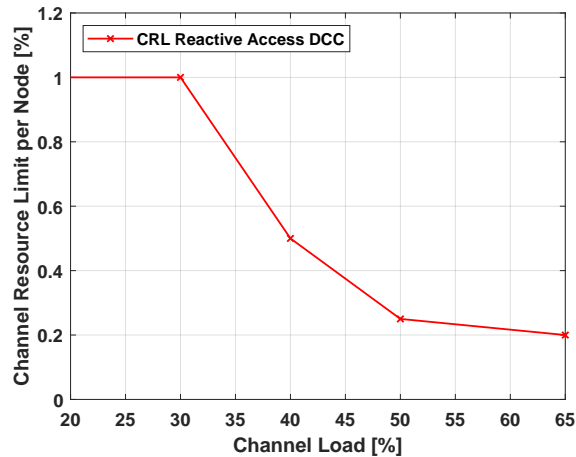

Figure 4.7: Continuous Channel Resource Limit vs Channel Load for Reactive DCC

Modification 2: Smoother transition of CRL w.r.t Channel Load

Instead of switching states as in the present Reactive DCC, the channel resource limits of Table 4.4 are mapped to channel load using a continuous function instead of a step function, as represented by the graph of Figure 4.7. This results a smooth reaction of the CRL w.r.t channel load, instead of rapid jumps.

To further avoid overreaction to rapid channel load variation, the new CRL is calculated as:

$$\text{new CRL} = 0.5 * \text{previous CRL} + 0.5 * \text{new CRL.}^5$$

The performance improvement of Reactive DCC after implementing modifications 1 and 2 is shown in Figure 4.8. The channel load of Figure 4.8c has much less oscillation compared to Figure 4.5c. Similarly, the channel usage rises from 45% to 60%, compared to the standardized version in Figure 4.5d. However, the overall communication performance, ITT and IRT improve even further after implementing modification 3, as discussed below.

Modification 3: Less severe rate control:

The Transmit Rate limit in Table 4.3, proposed in the ETSI standard starts rate

⁵A similar filter is applied for channel load calculation in the ETSI standards, as discussed in Chapter 3. We use the same concept for Reactive DCC.

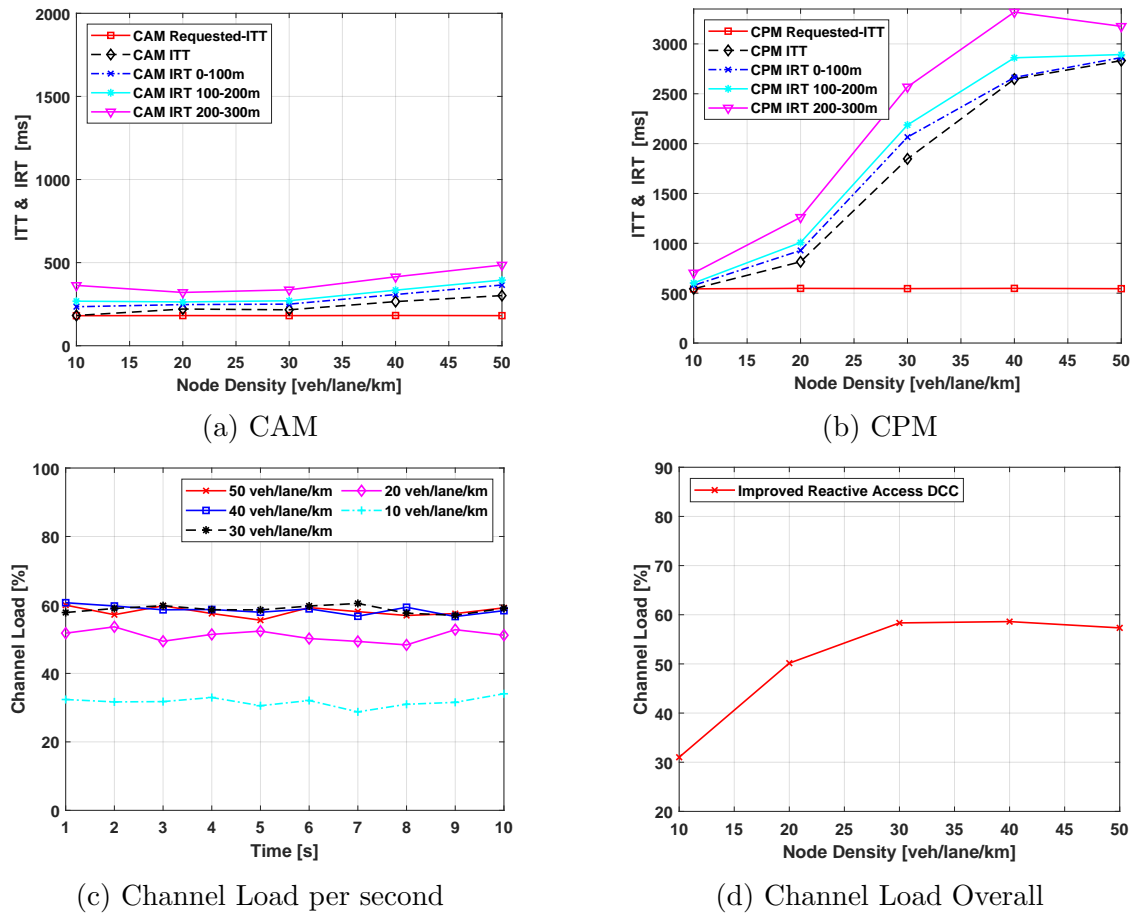

Figure 4.8: Performance of Improved Reactive DCC, with rate control starting at 30% CL

control from as low as 30% channel load, which gives the performance as shown in Figure 4.8. However, we evaluated by shifting the CL values by 10% i.e. starting CRL control from 40% CL, instead of 30%, according to the parameters in Table 4.5. This increases the communication performance even further, and is able to limit the CL at around 70%. In Table 4.5, the minimum CRL a node can have is 0.05%, which can accommodate 1400 vehicles at CL of 70%, which should be sufficient for any realistic traffic density. Therefore, the lowest CRL can be limited to 0.05% and may not have to be decreased further. Similarly, Figure 4.9 shows the smoothing of the CRL via a continuous relation which is used instead of the discrete values of Table 4.5.

Channel Load	Channel Resource Limit (CRL) per Node
<40%	1%
<50%	0.50%
<65%	0.25%
<75%	0.20%
>=75%	0.05%

Table 4.5: CRL Control Parameters starting at 40% CL

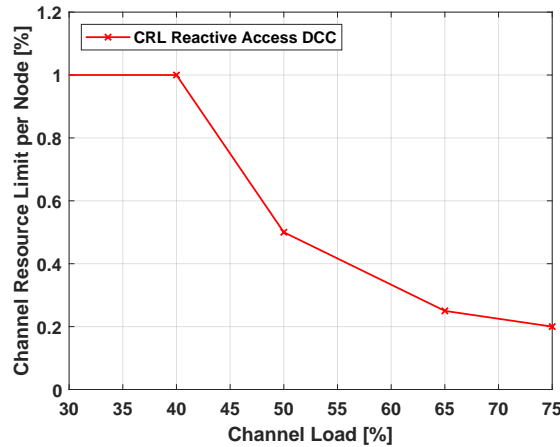

Figure 4.9: Continuous CRL vs CL for Reactive DCC

Figure 4.10 shows the overall performance of Reactive DCC after implementing the aforementioned improvements, showing significant performance improvement compared to the standardized Reactive DCC performance of Figure 4.5. The oscillation of channel load is no longer present, and the channel capacity usage increases from 45% to 60%. These two factors, decrease the CAM IRT from 1200ms to 450ms, at a distance of 300m, for the highest vehicle density of 50 veh/lane/km. Nevertheless, the performance of CPM is worse at higher channel load, giving an IRT of 2900ms, at a distance of 300m for a density of 50 veh/lane/km, compared to the IRT of 2600ms using simple Reactive DCC. This is because allocating channel resource giving absolute priority to a higher TC starves a lower priority TC.

A previous study [34] has shown that Adaptive DCC, (or the transmit rate control mechanism of it called LIMERIC [51]) performs better than Reactive DCC. However, after the above modifications the performance of Reactive DCC is almost as good as Adaptive DCC as shown in Figure 4.11. Adaptive DCC is discussed in the next subsection.

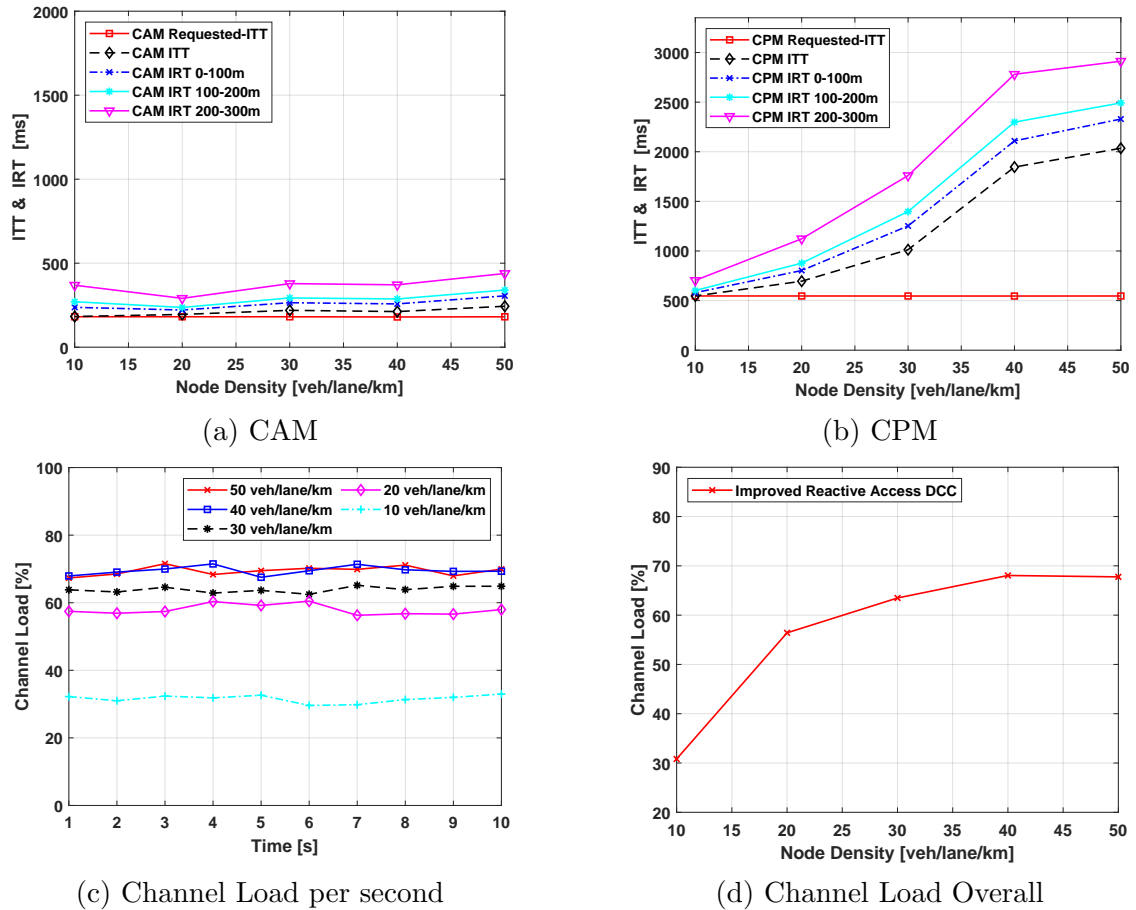

Figure 4.10: Performance of Improved Reactive DCC, with rate control starting at 40% CL

4.3.5 Adaptive DCC

Compared to standardized Reactive DCC, standardized Adaptive DCC performs much better because Adaptive DCC targets a channel load of 68% and allows each node to use the available channel capacity to converge to the target CL and maintain it around 68%, as can be seen in Figure 4.11c. Similarly, the rate change is gradual instead of state based transition. Lastly, the unit of resource allocation per node is the channel resource (CR) and not transmit rate (TR) as in the case of Reactive DCC.

Figure 4.11 shows the communication performance of Adaptive DCC at the Access layer. The requested ITT of 200ms for CAM is almost satisfied for all the vehicle densities. However, this comes at a cost of degraded performance for CPM as the node density increases. This is due to the fact that in all the simulations

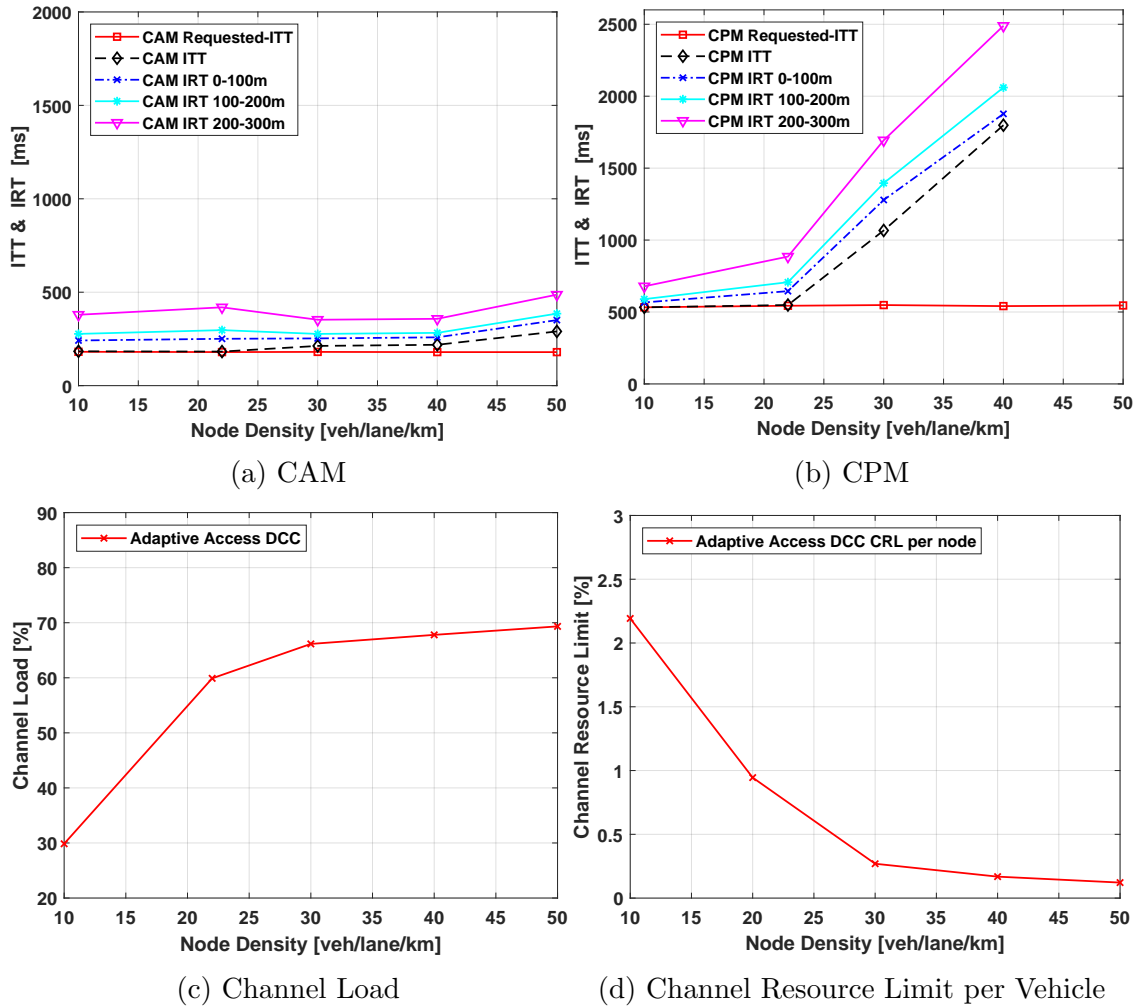

Figure 4.11: Application performance with Adaptive DCC (TC 2 for CAM and TC 3 for CPM)

until now, CAM has a higher priority Traffic Class⁶ i.e. TC 2, while CPM has a less priority traffic class, TC 3. Therefore, using absolute priority DCC queuing, CAM are always fully satisfied before allowing CPM, regardless of whether the rate control mechanism is Adaptive or Reactive, as discussed in Chapter 3, Section 3.6. Similarly, at a vehicle density of 50 veh/lane/km, CPM gets no transmit opportunity at all, and is starved indefinitely. This can be further understood from Figure 4.11d, which indicates the CRL per node. At 50 veh/lane/km, each vehicle gets 0.12% of channel resource with which it can transmit: $0.12 \times 750000 / 100 = 900$ Bytes/sec, considering 6Mbps or 750000 Bytes/sec data rate. Therefore, the vehicle spends that to transmit around 3Hz CAM as shown in Figure 4.11a, leaving no resource for CPM.

In the next section, we analyze the application performance by allowing CAM and CPM to have same priority of TC 2. As Adaptive DCC performs better than standardized Reactive DCC, and the performance level of Reactive DCC after our

⁶For the sake of simplicity we only consider the priority field of DP which is the TC and use the terms interchangeably

proposed improvements is almost similar to Adaptive DCC, for analysis of other aspects of DCC, we will use Adaptive DCC at the Access layer, unless otherwise indicated.

4.4 DCC Access Queuing

The last section analyzed the rate control aspect of DCC, i.e. limiting the transmit rate w.r.t channel load. In this section, we move upwards in the Access layer and focus on the DCC queues, inside which packets wait before being dequeued when the respective Traffic Class gets a transmit opportunity by the Leaky bucket flow control or Gate Keeper. ETSI standards do not mention the queuing method, nor the queue size, which are left to be implementation specific. In this section we analyze the effect of TC, packet generation rate and the queue size on the application QoS.

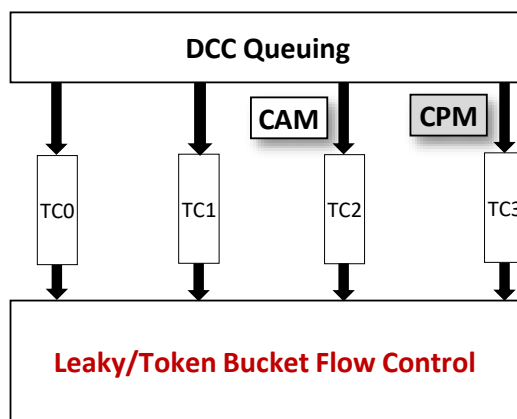

Figure 4.12: DCC Queue

4.4.1 Effect of Traffic Class & Packet Generation rate per Service

In ETSI specifications, CAM always has TC 2, whereas for CPM the TC has not been specified in the standard. In the last few sections CPM was given TC 3, as shown in Figure 4.12. In this subsection, we analyze by increasing the priority of CPM.

When both CPM and CAM are put in TC 2, the ITT of CPM decreases around 200 to 300 ms as shown in Figure 4.13, when compared to TC 3 of CPM. For density of 30veh/lane/km, the ITT is 800 ms, compared to 1050 ms for CPM in TC 3 as shown in Figure 4.11 and likewise for other densities. Similarly, at 50veh/lane/km there is some CPM transmission instead of total starvation. However, the performance improvement of CPM comes at a cost of around 50 ms performance degradation of CAM, compared to Figure 4.11.

Even though CAM and CPM have the same TC and are enqueued in the same DCC queue of TC2, but the performance of the two applications are not similar even if both receive the same QoS via TC 3 and EDCA Access Category Best Effort.

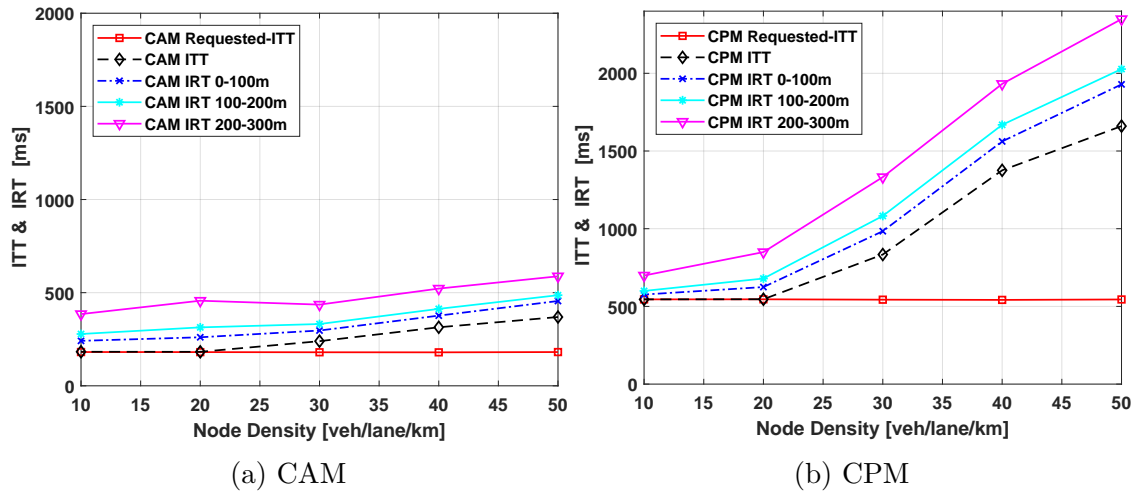

Figure 4.13: Application performance with Adaptive DCC, same TC for CAM and CPM

The difference between the requested and actual ITT is much higher for CPM than CAM. This can be explained by the fact that the DCC queues have a default size of 1 to allow a newer packet to erase an older packet waiting in the queue, and the newer packet be transmitted, as explained in Section 3.6.3. However, this jeopardizes the QoS policing, when two different applications belong to the same TC and have different packet generation rates. In this simulation, CAM are generated at an average rate of 5Hz, whereas CPM at 2 Hz.

During channel congestion, when the total packet arrival rate is higher than the DCC transmit rate, with a queue size of 1 the application with higher packet arrival rate has a higher probability to erase a packet from the application with a lower arrival rate waiting in the queue, and thus get a better transmit rate overall.

4.4.2 DCC Queuing: Same Traffic Class & Equal Packet Generation per Service

We analyze the allocation of transmit opportunity, when the two applications belong to the same TC generate packets at the same rate in order to compete more equally. Figure 4.14a shows the allocated ITT to CAM and CPM when both demand an ITT of 180ms. In this simulation, CPM ITT is fixed to 180ms, while CAM stochastically obtains an average ITT of 180ms, as a function of the vehicle's mobility.

Compared to earlier scenarios, the difference in allocated ITT between CAM and CPM is much lesser, as they both belong to the same TC, and enqueued in the same queue. Similarly, at some instances CPM gets a better IIT at the expense of a lower ITT for CAM and vice-versa. This depends on the order of arrival of the packets in the queue. As the queue size is only 1, the service which generates a packet just before the next DCC transmit opportunity, will erase an existing packet in the queue from another service, thereby obtaining a better QoS. Similarly, Figure 4.14b shows a similar pattern, for the percentage of non-transmitted packets from each application, which can be either dropped from the queue after a TTL of 1

second⁷ or erased by another packet.

Therefore, to mitigate this problem, the packet generation at the Service layer has to be synchronized with the Access layer DCC-TxOp, and coordinated among the services. Section 4.5 analyzes this functionality of the cross-layer coordination between packet generation and DCC Access.

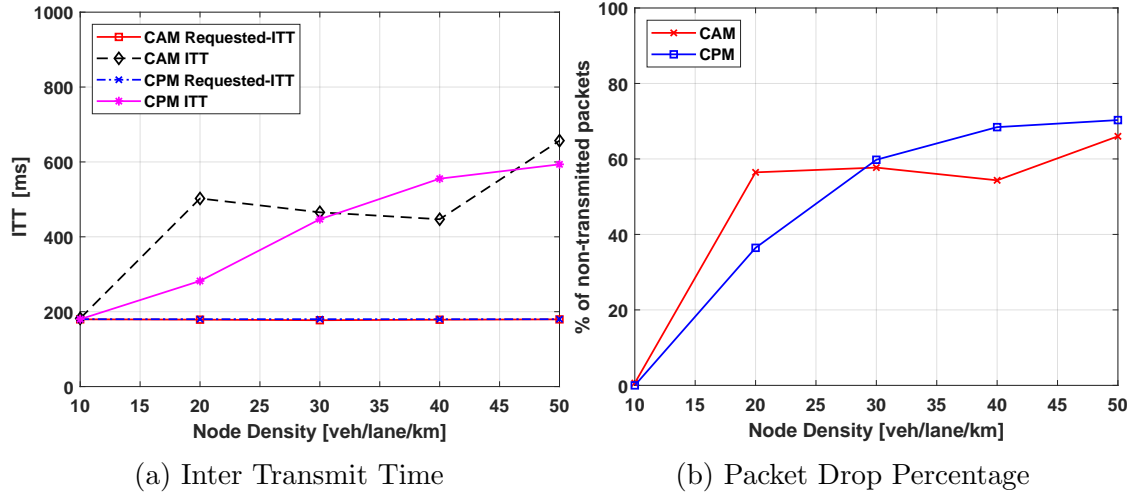

Figure 4.14: ITT with Adaptive DCC, same TC for CAM and CPM, same packet generation rate

4.4.3 Effect of Queue Size

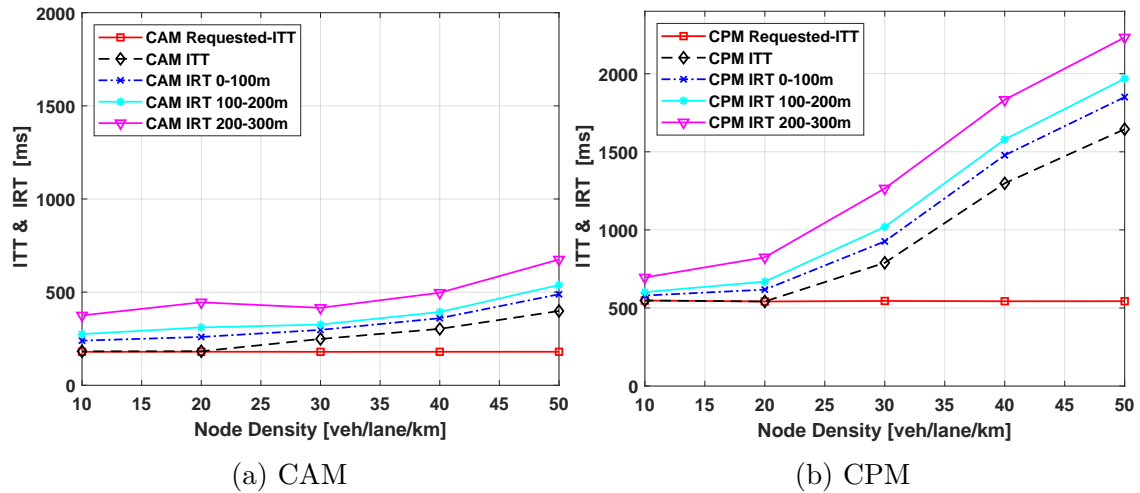

Figure 4.15: Application performance with Adaptive DCC, with queue size = 10

In this subsection we analyze the effect of DCC queuing when the queue size is more than 1, i.e. 10, and a Last in First Out (LIFO) mechanism is used for queuing, to transmit a newly generated packet than a packet already waiting in the queue.

⁷Maximum packet lifetime of GeoNetworking packet is set to 1 second for CAM[3] and other Single Hop Broadcast packets [9]

As the system has been designed considering a single type of message i.e. CAM, therefore the design goal is that a CAM containing more recent sensor information can safely substitute a CAM containing older information and itself be transmitted, as discussed in Chapter 3 Section 3.4.2.2.

However, as can be seen in Figure 4.15, the performance using a queue size of 10 is similar to the case of having a queue size of 1 as in Figure 4.13, i.e. CPM performance is worse than CAM at high channel load. A similar reasoning follows in this case as with queue size 1. When the arrival rate of CAM is higher, a newly arrived CAM pushes a CPM backward in the queue, which eventually may get dropped from the queue as the TTL is 1 second, as mentioned earlier. Therefore, having a queue size greater than 1 with LIFO strategy does not change things.

4.4.4 DCC Queuing Delay

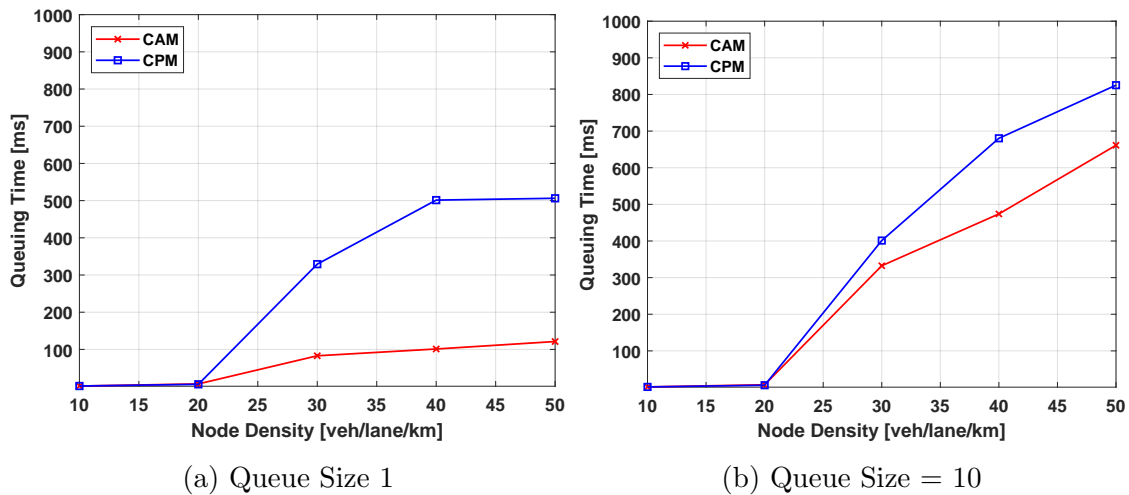

Figure 4.16: Time spent by all packets (transmitted and non-transmitted) in DCC queue

In this subsection we analyze the queuing delay w.r.t the queue size. Figure 4.16 shows the time spent in the DCC queues by CAM and CPM in the DCC Access layer queues, for a queue size of 1 in Figure 4.16a and a queue size of 10 in Figure 4.16b. The graphs represent all packets staying in the queues, whether transmitted or dropped after a TTL or being erased by another packet.

With a queue size of 1, the delay is shorter as an existing packet gets erased by a new packet, giving an average queue time of 100ms for CAM and 500ms for CPM for the highest vehicle density. The delay is longer with a queue size of 10 with LIFO queuing, where a packet is pushed to the back of the queue, giving an average queue time of 650ms and 800ms for CAM and CPM respectively for the highest node density.

As the packet Inter Arrival Time is 180ms for CAM and 500ms for CPM, and as it is always preferable for safety applications that a packet containing the most up to date information is transmitted, therefore when the queue time is higher than inter arrival time, a multi-layer queue is of no use, and a single layer queue is enough. However, with multiple applications in the same TC, a single layer queue is

Table 4.6: Rate Limits for different ETSI DCC Profiles

DCC Profile DP	CCH DCC State Relaxed	CCH DCC State Active	CCH DCC State Restrictive
DP0	Toff \geq 50 ms	Toff \geq 50 ms	Toff \geq 50 ms
DP1	Toff \geq 95 ms	Toff \geq 190 ms	Toff \geq 250 ms
DP2	Toff \geq 95 ms	Toff \geq 190 ms	Toff \geq 250 ms
DP 3	Toff \geq 250 ms	Toff \geq 500 ms	Toff \geq 1000 ms

problematic as discussed earlier, i.e. packet from one application erases the packet of another application.

Nevertheless, a detailed queuing theory analysis has not been provided here, as our goal is not to improve the queuing mechanism, but to shift the traffic shaping intelligence to the Service layer and synchronize the Service layer with the Access layer DCC, which can eventually eliminate the need for queuing, and yield a zero queuing time.

The points observed in this section about DCC queuing and traffic shaping can be summarized as follows:

- If two services are put in different TC and enqueued in different queues, the lower priority service is starved during high channel load.
- If two services are put in the same queue, then a service erases the packet of another service. The service with the higher packet generation rate contends better and gets better QoS.
- A similar problem occurs using a multi layer LIFO queue, where a service with higher packet generation rate drives the packet of another service backwards which eventually gets dropped, after a TTL of 1 sec.
- The packet age in a queue increases with higher channel load, and is more for a multi layer queue than a single layer queue.
- Similarly, a multi layer queue is of no use for V2X safety applications when the packet inter arrival time is lower than the age of packets in the queue.

Therefore, one way to mitigate these problems can be to avoid generating excess packets and control the packet generation with respect to the channel load. In this regard, several functionalities at the Service/Facilities layer have been proposed in the ETSI standards, as analyzed in the next section.

4.5 DCC Cross Layer Coordination

In this section we analyze several DCC cross layer coordination mechanisms in the ETSI standards, for controlling the packet generation rate at the Service/Facilities layer as a function of the channel congestion level and the application priority. The goal is to provide more opportunity to applications with higher priority and avoid generating excess packets by applications, as the packets would queue up in the DCC queues and create the problems analyzed in the previous section.

As discussed in Chapter 3 Section 3.4.3, ETSI standards propose two mechanisms for this purpose, which are :

1. Packet generation control (PGC) via Transmit Rate Limit (TRL), which maps the channel load to the minimum packet generation interval for each Traffic Class or DCC Profile, according to Table 4.6⁸. In the standards, the inter packet generation interval w.r.t DCC are called T_GenCam_DCC [3] and T_GenCpm_DCC [108]. In this thesis, we refer to this functionality as PGC via TRL.
2. Packet generation control via CRL Limit, which takes the CRL for the node calculated by Access DCC, and divides it as CRL per application, according to:

$$CRL_{Node} = \frac{T_{on,app1TC1}}{T_{on,app1TC1} + T_{off,app1TC1}} + \dots + \frac{T_{on,appNTCN}}{T_{on,appNTCN} + T_{off,appNTCN}} \quad (4.1)$$

Again, in the draft ETSI standard TS 103 141 [30], the name PGC via CRL does not exist, but we refer to this functionality as such in this thesis, for the purpose of convenience.

⁸This table has been presented in chapter 3, presented here again for the ease of readability

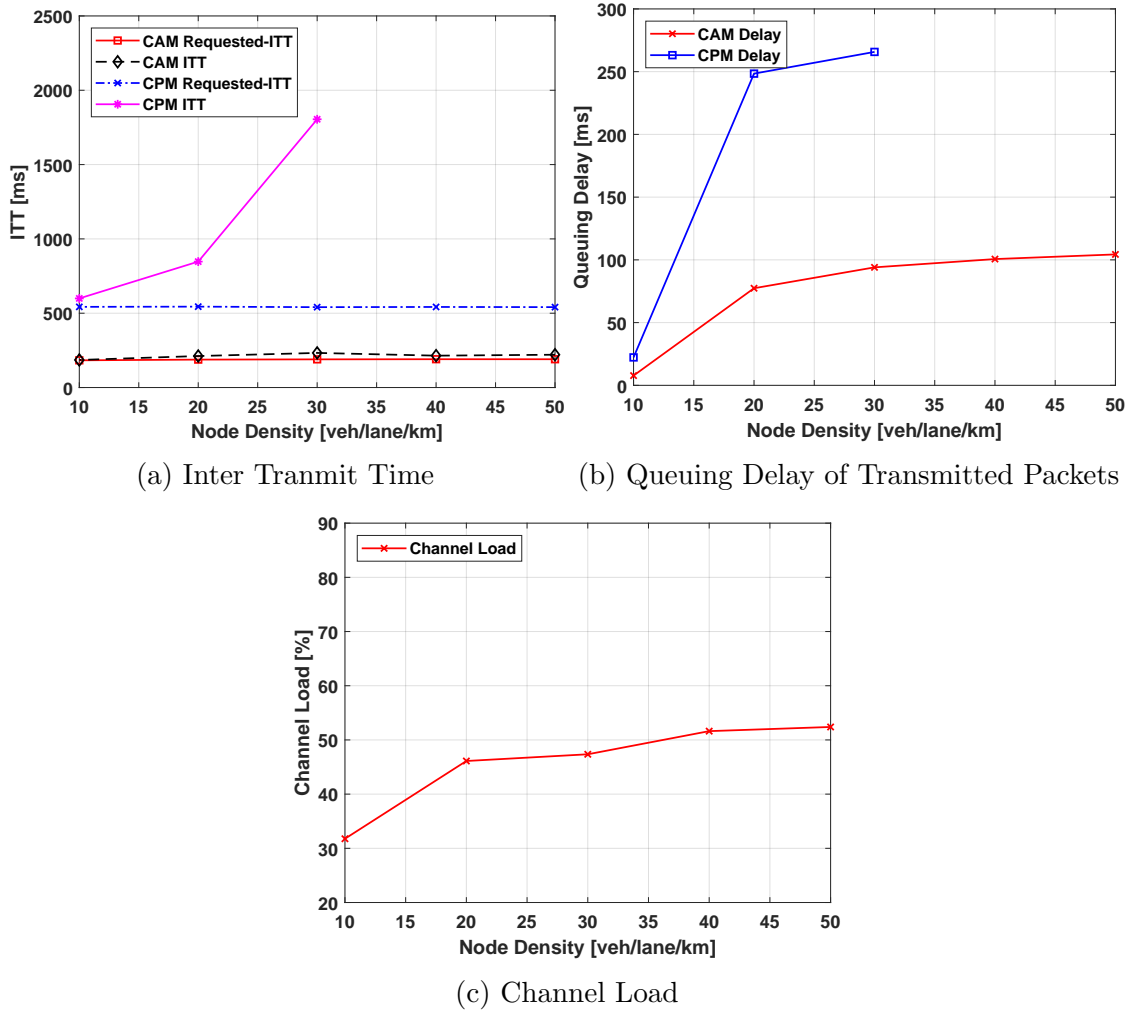

Figure 4.17: PGC via TRL on top of Reactive Access DCC

In this section, we analyze the performance of these two mechanisms at the Facilities layer, on top Reactive and Adaptive DCC, analyzing 4 possible combinations altogether. The metrics of evaluation are the queuing delay of the transmitted packets, and the ITT allocated to CAM and CPM, belonging to TC/DP 2 and 3 respectively. The IRT has not been presented for the sake of avoiding redundancy. The evaluation scenario is the bidirectional highway as presented earlier in this chapter.

4.5.1 Packet Generation Control via Transmit Rate Limit on top of Reactive Access DCC

Figure 4.17, shows the communication performance when the packet generation at the service layer in each node is controlled using Table 4.6 and DCC at the Access layer follows Table 4.3. Even at low channel load/node density, the performance of CPM in Figure 4.17a is much worse than Figure 4.5, which uses only Table 4.3 at the Access layer. This is because, the rate control parameters of Table 4.6 are much more aggressive than Table 4.3 for DP3, causing this performance degradation. Similarly, CPM is starved for a node density of 30veh/lane/km and above. However, the performance of CAM is not affected, as the the rate parameters of DP2 are more generous in Table 4.6.

The primary function of PGC is to limit the packet generation and avoid excess packet generation and DCC Access layer queue delay. In this regard, PGC via TRL cannot fully negate the delay, giving a delay of around 80 to 100 ms for CAM and over 250ms for CPM, for node density of 20veh/lane/km and above. This is because there is no direct coordination or synchronization between the next Access layer DCC-TxOp and the PGC. Similarly, there is no coordination between the PGC of two different services, leading to a lack of arbitration for allocating the next Access layer DCC-TxOp to a particular service, as discussed in Section 3.6.6.3.

4.5.2 Packet Generation Control via Transmit Rate Limit on top of Adaptive Access DCC

Figure 4.18, shows the communication performance when the packet generation at the service layer in each node is controlled using Table 4.6 and there is Adaptive DCC at the Access layer. As there is no DCC state associated with Adaptive DCC, so the DCC states, i.e. Relaxed, Active and Restrictive of Table 4.6 are mapped to CL according to Table 4.3.

Compared to the earlier scenario of Figure 4.17, the performance is better as Adaptive DCC exploits the available channel capacity much more than Reactive DCC, as demonstrated in Section 4.3.5 of this chapter. Similarly the queuing delay is also lesser in this scenario, producing an average delay of around 80ms for the highest node density. Nevertheless, the delay is not fully zero, as the issue of synchronizing with the Access layer DCC-TxOp and arbitration among the applications with regards to allocating the DCC-TxOp still remain.

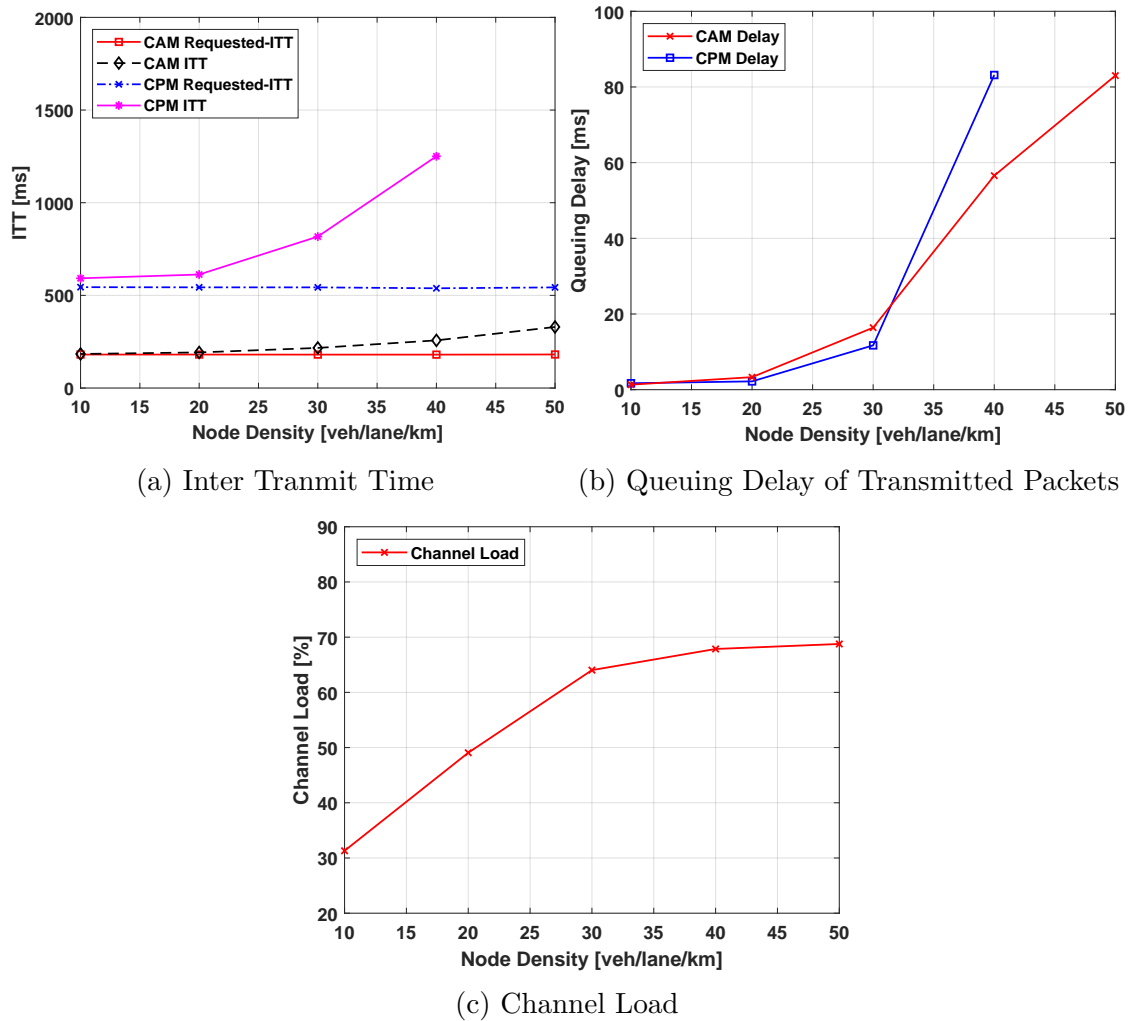

Figure 4.18: PGC via TRL on top of Adaptive Access DCC

4.5.3 Packet Generation Control via Channel Resource Limit on top of Adaptive DCC

Figure 4.19, shows the communication performance when there is channel resource allocation to each application at the Facilities layer on top of Adaptive Access DCC, instead of packet generation control. At low channel loads, the performance of CPM is better than the two earlier scenarios, whereas at high loads CPM is completely starved and no resource is given to CPM. This is because, Eq. 4.1 allocates resource to a lower TC only if there is any left over after allocating to a higher TC. Moreover, at the Access layer, there is Adaptive DCC which also faces the starvation issues as shown in Figure 4.11.

Similarly, there is over 80ms of queuing delay for CAM for the highest node density, as shown in Figure 4.19b. Even with this combination of Facilities and Access DCC, the coordination between the layers and arbitration among the applications still remain.

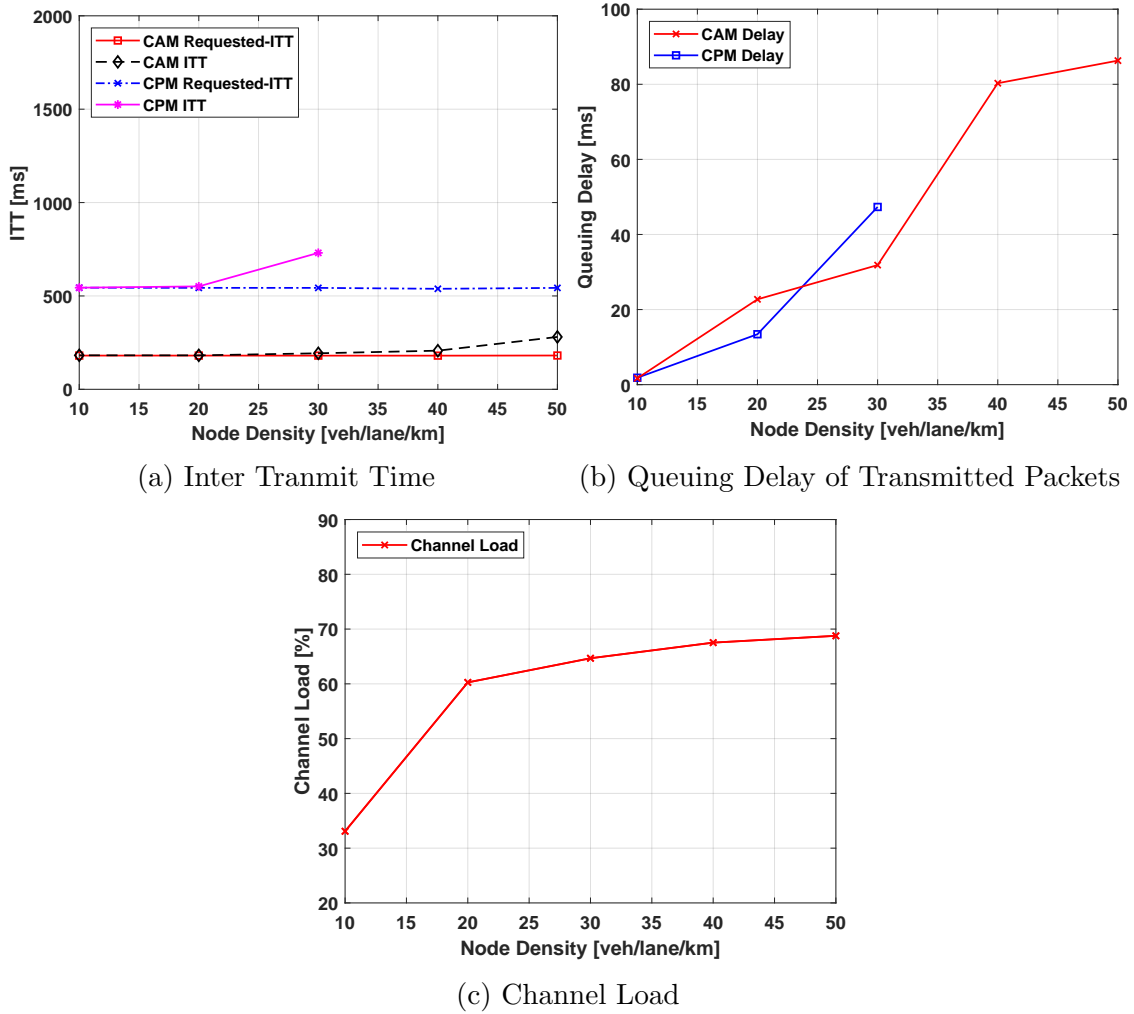

Figure 4.19: PGC via CRL on top of Adaptive Access DCC

4.5.4 Facilities DCC on top of Improved Reactive DCC

CRL control is not compatible with ETSI Reactive DCC, due to the fact that ETSI Reactive DCC does not take into account the packet size along with transmit rate, as indicated in Chapter 3 Section 3.6.6. Therefore, we evaluate the performance of CRL control on top of our improved reactive DCC, implementing the improvements mentioned in Section 4.3.4.

Figure 4.20, shows the performance when each node has CRL control at the Facilities layer on top of improved Reactive DCC. The performance is similar to the earlier case of Facilities layer CRL control on top of Adaptive DCC, allowing very good ITT to CAM at any channel load and starving CPM at high channel loads. As indicated earlier, the improvements to Reactive DCC proposed in Section 4.3.4, mitigates the shortcomings of Reactive DCC and makes it similar to Adaptive DCC.

Nevertheless, like the other combinations in this chapter, this combination also cannot prevent queuing delay, which is as much as 80ms at the highest channel load, due to the same reasons of lack of coordination between Facilities and the Access layer DCC, as explained earlier.

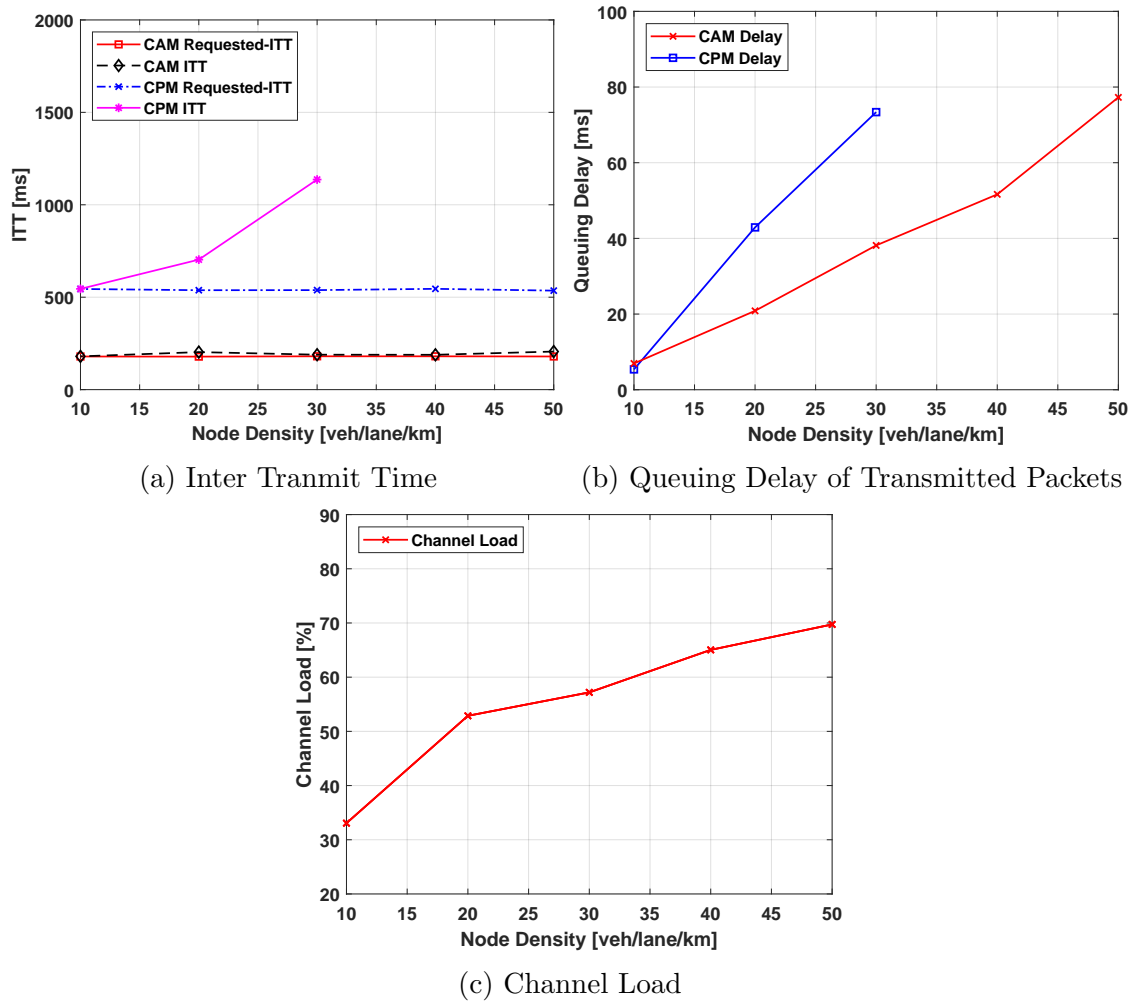

Figure 4.20: PGC via CRL on top of Improved Reactive Access DCC

Thus, in this section we demonstrated several issues with the coordination of packet generation control via TRL or CRL at the Facilities layer over both Reactive and Adaptive DCC at the Access layer. Although PGC via transmit rate or channel resource regulate the allocation based on the channel load, but there is a lack of synchronization of packet generation and Access DCC. Secondly, there is a lack of arbitration of the Access DCC-TxOp at the Facilities layer among the services. These two conditions make it impossible to avoid the DCC Access layer queuing delay, resulting transmission of messages containing old information and reducing information freshness.

In this regard, we design a Facilities layer resource orchestrator, which mitigates the aforementioned issues, i.e. negates the queuing delay and allows controlling the amount of resource to allocate to each application, as presented in the next section. Table 4.7 summarizes the issues found with the existing combinations of Access and Facilities layer rate control, and lists our proposed resource orchestrator, which can solve those issues, as will be presented in the next section.

Table 4.7: DCC Cross Layer Issues solved by the proposed Resource Orchestrator

	PGC TRL+ Reactive	PGC TRL+ Adaptive	PGC CRL + Adaptive	PGC CRL + Improved Reactive	Proposed Orchestrator + Adaptive
Synchronize Access with Facilities packet generation	No	No	No	No	Yes
Coordinate packet generation opportunity among applications	No	No	No	No	Yes
Eliminate DCC queue delay	No	No	No	No	Yes
Avoid DCC queue packet erasing of one application by another	No	No	No	No	Yes
Maximize channel capacity usage	No	Yes	Yes	Yes	Yes
Flexible & Dynamic resource allocation among applications eliminating starvation	No	No	No	No	Yes

4.6 Facilities Layer Resource Orchestration

In this section we present our proposed Facilities Layer Resource Orchestrator.

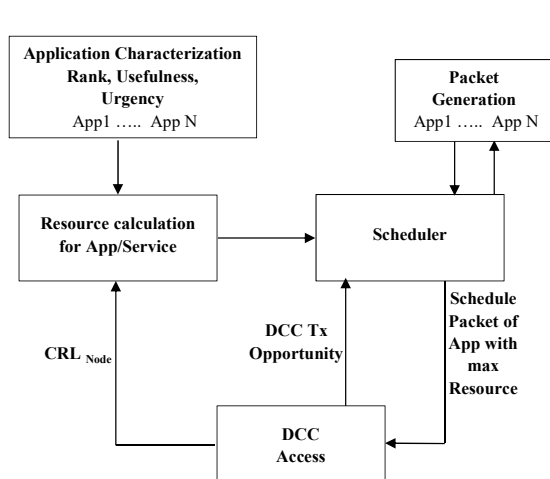

Figure 4.21: Resource Orchestrator Block Diagram

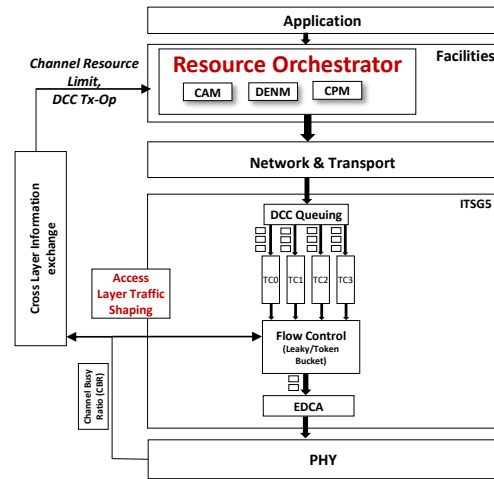

Figure 4.22: Orchestrator in the ETSI ITS Stack

The system block diagram is shown in Figure 4.21, which can be described by the following functionalities:

1. Each application or service⁹ provides the required QoS information to the initial function whose aim is to extrapolate the most stringent requirements for each type of application.
2. Another function characterizes each type of application using N_{prop} properties to calculate the application's share of the node's total transmission opportunity and its resource quota at any instance.

⁹To recall, for simplicity the words application and service are used interchangeably in this analysis.

3. Another function schedules the next packet from the application having the highest resource quota. It obtains information about the next transmit opportunity from Access Layer DCC and harmoniously coordinates the packet generation of the application having the highest resource to synchronize with the next DCC-TxOp, thus avoiding the DCC queuing delay as discussed in the previous section.

The design is modular and each block is independent from the other. The scheduler will work even if the internal workings of the ETSI Access DCC or the internal functions of the resource calculation block are modified, as long as the input to each block is satisfied. Figure 4.22, shows the orchestrator at the Facilities layer in the ETSI ITS stack.

4.6.1 Application characterization function

This function exposes a set of properties N_{prop} to the client applications. Those properties correspond to all the potential properties that can be used in order to optimize the allocation of the resource quota of the node among the applications. Each application subscribes to this function requesting specific V2X message and their associated QoS.

As an example the subscription could be described as:

Subscription Application '0' = $\langle \text{Msg0}, p_0, \dots, p_{N_{prop}}, \text{Msg1}, p_0, \dots, p_{N_{prop}}, \dots \rangle$
 \rangle
 Subscription Application '1' = $\langle \text{Msg0}, p_0, \dots, p_{N_{prop}}, \text{Msg1}, p_0, \dots, p_{N_{prop}}, \dots \rangle$
 \rangle
 ...
 Subscription Application 'l' = $\langle \text{Msg0}, p_0, \dots, p_{N_{prop}}, \text{Msg1}, p_0, \dots, p_{N_{prop}}, \dots \rangle$

Where $p_0 \dots p_{N_{prop}}$ corresponds to the values associated to the N_{prop} properties which are exposed by the function. In a specific embodiment, all the properties used in order to define the scheduling algorithm can be exposed to the applications and the values requested by each of the applications can be used in order to provide the set of parameters $p_0 \dots p_{N_{prop}}$. In a different embodiment only a subset of the N_{prop} properties can be exposed to the applications and this function autonomously defines the values associated to the remaining properties.

In one embodiment the following $N_{prop} = 3$ properties are considered. In this chapter, the examples and the simulation results are provided based on the following properties.

1. **Rank:** A primary differentiator to differentiate between applications of different priority. In one embodiment it can be of 4 levels having values of 1, 0.75, 0.5 and 0.25 to resemble the 4 traffic classes.
2. **Usefulness:** A usefulness metric measures how useful is the message in the context. For example, CAM and CPM may belong to the same traffic class, but a CAM is useful for all the neighboring vehicles, whereas CPM may or may not be useful for everybody. Thus if a packet is useful to all the neighbors, it can have a usefulness values of 1, whereas 0.5 if only 50% of neighbors will

be needing it. Similarly, if two applications have the same traffic class, they can be differentiated using a usefulness metric.

3. **Urgency:** An urgency metric is necessary to indicate how soon an application needs to transmit the information. For example, each application can provide a deadline to the facilities layer, before which it needs to transmit a packet. At the beginning, the urgency can be 0, which can gradually increase as the deadline approaches, increasing the urgency of the application to send a packet.

4.6.2 Application Resource Calculation

The priority coefficient of each application P_{App_i} can be defined as a weighted sum of the N_{prop} properties (example given for the $N_{prop} = 3$ properties defined above):

$$P_{App_i} = \alpha_1 Rank + \alpha_2 Usefulness + \alpha_3 Urgency + \dots \quad (4.2)$$

Every 100 milliseconds, the Access DCC calculates the Channel Resource Limit (CRL) for the Node. As explained earlier, this limit basically sets the proportion of time the particular node can use the channel to transmit its packets. If a node transmits a longer packet, then it will have to abstain from transmission for a proportionate amount of time, to respect the ratio, which is given by Eq. 4.3, illustrated here again for clarity:

$$CRL_N = \frac{T_{onNode}}{T_{onNode} + T_{offNode}} \quad (4.3)$$

Where CRL_N corresponds to the Channel Resource Limit for node ‘N’. This limit can be considered as a quota of transmission resource, which is divided into the different applications of the node re-illustrated using Eq.4.4, :

$$CRL_N = \frac{T_{onNode}}{T_{onNode} + T_{offNode}} = \frac{T_{on,App1}}{T_{on,App1} + T_{off,App1}} + \dots \frac{T_{on,Appk}}{T_{on,Appk} + T_{off,Appk}} \quad (4.4)$$

Every 100ms when a new CRL for the Node comes from the Access DCC, the resource calculation functionality in Figure 4.21 determines the priority of each application, using Eq. 4.2. This priority is used to calculate the resource percentage of each application as:

$$R_i = \frac{P_{App_i}}{\sum_k P_{App_k}} \quad (4.5)$$

The stock of resources at time instant ‘t’ can be computed as the Existing resource at time instant ‘t’ + Resource Earned – Resource Spent. After transmitting a packet of airtime T_{onApp_i} duration, the application should wait during T_{offApp_i} period. The resources earned depends on the amount of time that the application has waited before transmitting again. If the application waits a T_{offApp_i} period of time, it earns sufficient amount of resource to again send a packet of airtime T_{onApp_i} . The resource it spends to transmit the new packet is given by the T_{onApp_i} of current transmission ‘t’ \div T_{onApp_i} of last transmission ‘t-1’. After transmitting a packet of T_{onApp_i} , if the application waits T_{offApp_i} , and again transmits another

packet of same airtime Ton_{App_i} , the balance of its Resource Earned – Resource Spent will be 0.

The resource percentage of each application, determines the Channel Resource Limit or channel resource share of the application as:

$$CR_i = \frac{Ton_{App_i}}{Ton_{App_i} + Toff_{App_i}} = R_i * CRL_N \quad (4.6)$$

Therefore, connecting Eq. 4.4 and 4.6, it can be expressed as:

$$\begin{aligned} CRL_N &= \sum_i CRL_N * R_i = \sum_i CR_i \\ &= \sum_i \frac{Ton_{App_i}}{Ton_{App_i} + Toff_{App_i}} \end{aligned} \quad (4.7)$$

If an application, transmits a packet of air time, Ton_{App_i} , it has to wait a time $Toff_{App_i}$, before it is again allowed to transmit another packet, of air time Ton_{App_i} . If it waits half that time, it will be able to transmit a packet half the air time of Ton_{App_i} . Analogously, it can be said that after waiting $Toff_{App_i}$ duration, the application has earned enough resources to transmit a packet of airtime Ton_{App_i} .

The earning of resource $E_i(\Delta t)$ over a duration Δt can be expressed as:

$$E_i(\Delta t) = \frac{\Delta t}{Ton_{App_i}(t-1) + Toff_{App_i}(t-1)} \quad (4.8)$$

Where Δt corresponds to the Time since the Last Transmission (TSLT) by application ‘i’.

At any time, the net resource $A_i(t)$ of an application depends on the remaining resource after last transmission $A_i(t-1)$ plus the accumulated resource $E_i(\Delta t)$. It can be expressed as:

$$A_i(t) = A_i(t-1) + E_i(\Delta t) \quad (4.9)$$

By replacing $Toff_{App_i}$ using Eq. 4.6 and 4.8 , it becomes:

$$\begin{aligned} A_i(t) &= A_i(t-1) + E_i(\Delta t) \\ &= A_i(t-1) + \frac{\Delta t}{Ton_i(t-1) + Toff_i(t-1)} \\ &= A_i(t-1) + \frac{\Delta t}{Ton_i(t-1)} * CRL_i \\ &= A_i(t-1) + \frac{\Delta t}{Ton_i(t-1)} * R_i * CRL_N \end{aligned} \quad (4.10)$$

Whenever the next transmit opportunity is allowed by the Access DCC, the accumulated resource of each application is calculated and the application with the highest resource is allowed to transmit by the orchestrator, as shown in Fig 4.21. Each transmission costs resource to the application. As stated earlier, after transmitting a packet of duration $Ton_i(t-1)$, the node has to wait a Δt before transmitting the next packet $Ton_i(t)$. If $\Delta t = Ton_i(t-1) + Toff_i(t-1)$, the node has earned $E_i(\Delta t) = 1$, according to Eq. 4.8, and can transmit another packet of $Ton_i(t) = Ton_i(t-1)$, and the net resource will be zero.

Table 4.8: Scheduling Example by the Resource Orchestrator (The color is to highlight which packet is being transmitted each time)

Current Tme (ms)	DENM Resource	CAM Resource	CPM Resource	Packet Transmitted	Next Gate Open (ms)
100	0.5	0.30	0.1	DENM	200
101	-0.5	0.30	0.1	-	200
200	0	0.60	0.2	CAM	300
300	0.5	-0.10	0.3	DENM	400
400	0	0.20	0.4	CPM	600
600	1	0.80	-0.4	DENM	700
700	0.5	1.10	-0.3	CAM	800
800	1	0.40	-0.2	DENM	900
900	0.5	0.70	-0.1	CAM	1000
1000	1	0.00	0	DENM	1100

Therefore the cost of a transmission $C_i(t)$ can be expressed in terms of the currently transmitted packet's air time $Ton_i(t)$, as a proportion of the last transmission $Ton_i(t-1)$. Similarly, if it transmits twice the size, its cost will be 2, and $E_i(\Delta t) - C_i(t)$ will be -1. Thus, $C_i(t)$ can be expressed as:

$$C_i(t) = \frac{Ton_i(t) * (1 - CRL_i)}{Toff_i(t-1) * CRL_i} \quad (4.11)$$

The new net resource $A_i(t)$ is obtained as :

$$\begin{aligned} A_i(t) &= A_i(t-1) + E_i(\Delta t) - C_i(t) \\ &= A_i(t-1) + E_i(\Delta t) - \frac{Ton_i(t) * (1 - CRL_i)}{Toff_i(t-1) * CRL_i} \end{aligned} \quad (4.12)$$

Hence as anticipated, the resource stock of an application, is given by Existing resource + Resource Earned - Resource Spent. After transmitting a packet Ton_{App_i} , the application should wait $Toff_{App_i}$. The Resource earned is calculated as: Time waited $\div Toff_{App_i}$ as shown in Eq 4.8 (simplifying and considering $Ton \ll Toff$).

4.6.3 Packet Scheduling by the Resource Orchestrator

The Resource calculation functionality calculates and provides the resources of all the applications to the scheduler, as shown in Fig 4.21. The scheduler checks if the application with the highest resource has a packet to be transmitted, the application is allowed to generate and transmit a packet, otherwise the application with the next highest resource is queried if it has a packet for transmission.

Let's use an example to further clarify the process. Let's say a node has 3 applications DENM, CAM and CPM. DENM has a Rank of 0.75, CAM 0.5 and CPM 0.25. For simplicity, let the weight of each factor be 1 and DENM is always urgent with urgency value 1, and the other two applications are not urgent with urgency value 0. Let the usefulness value be 1 for all the applications. Then the priority values of each application will be:

$$\text{DENM} = 0.75 + 1 + 1 = 2.75$$

$$\text{CAM} = 0.5 + 0 + 1 = 1.5$$

$$\text{CPM} = 0.25 + 0 + 1 = 1.25$$

The sum of all the priority values is: $2.75+1.5+1.25 = 5.5$. The CRL of each application will be $2.75/5.5 = 0.5$ or 50% for DENM, 27% for CAM and 23% for CPM respectively. Let's round it to 50%, 30% and 20% for simplicity.

Let's say the node can use 0.4% of the channel resource allocated by Access DCC. Thus, $\text{Ton} \div (\text{Ton} + \text{Toff}) = 0.004$

If the node transmits 300 Byte packets, $\text{Ton Node} = 0.0004$ (400 μ sec, 300 bytes), Toff Node will be 0.996 (99.6 ms), allowing a 10 Hz transmission.

Let's say DENM and CAM are 300 Bytes and CPM is 600 Bytes. Therefore Channel Resource Limit per application can be calculated as:

$$\text{DENM CRL} = 0.5 * 0.004 = 0.002$$

$$\text{CAM CRL} = 0.3 * 0.004 = 0.0012$$

$$\text{CPM CRL} = 0.2 * 0.004 = 0.0008$$

$$\text{Ton DENM} = 0.0004 \text{ s } \text{Toff DENM} = 0.1996 \text{ s (5 Hz) 300 bytes}$$

$$\text{Ton CAM} = 0.0004 \text{ s } \text{Toff CAM} = 0.3329 \text{ s (3 Hz) 300 bytes}$$

$$\text{Ton CPM} = 0.0008 \text{ s } \text{Toff CPM} = 0.9992 \text{ s (1 Hz) 600 bytes}$$

Then according to the above resource orchestration mechanism, the orchestration will follow a pattern shown in Table 4.8. The first column shows the current time, followed by the net resource of each application at that time. The 4th column shows the packet transmitted from the application having earned the highest resource. The last column shows the earliest time when Access DCC will allow the next packet transmission after the *Toff* period.

As time passes each application earns resources as in Eq. 4.10, which are spent during packet transmissions as in Eq. 4.12. In Table 4.8, at 100ms DENM application has a resource of 0.5, higher than CAM and CPM, so the orchestrator allows a DENM transmission. Using Ton_{DENM} , $\text{Toff}_{\text{DENM}}$ and CRL_{DENM} values, its resource at 101ms, after the transmission is calculated by Eq. 4.12 as: $0 + 0.5 - (0.0004 * (1 - 0.002)) / (0.2 * 0.002) = -0.5$. Similarly, at 300ms, 200ms (0.2 sec) after its last Tx, its resource is calculated by Eq. 4.10 as: $-0.5 + 0.2 / 0.0004 * 0.5 * 0.004 = 0.5$. Similarly, at 600ms, its resource is 1, higher than the two other applications and a DENM is again sent, as shown in Table 4.8.

The Resource Orchestration Steps can be summarized as:

```

Step 0: A transmit opportunity is granted by the Access DCC, after
        waiting a Toff Node
Step 1: Obtain the Channel Resource Limit for the node for the current
        cycle
Step 2: Calculate the priority values for each application, f (traffic class,
        utility, urgency...)
Step 3: Calculate the share of the Channel Resource Limit by each
        application for the current cycle, using the priority values
Step 4: Add the resource share for each application for the current cycle to
        their existing resource
Step 5: if the application with the highest resource has a packet to be
        transmitted then
        | schedule its packet transmission
else
        | pass to the application with the next highest resource
end
Reduce the resource of the application which got the transmit opportunity,
        as a function of its packet size
if a packet was transmitted then
        | sleep and wake up; Restart from Step 0
else
        | sleep and wake up when any application has a packet to be transmitted;
        | Restart from Step 1
end

```

4.6.4 Resource Orchestration Performance Evaluation

We compare the application performance of the proposed Resource Orchestrator (RO), against the performance of PGC via Channel Resource Limit (CRL) as in the ETSI standard [30]. Although [30], is yet to be finalized¹⁰, for performance evaluation in this thesis, we use its design philosophy of channel resource allocation among applications using static TC. Similarly, there is a lack of synchronization with the Access DCC, as discussed earlier. The first metric of evaluation is the DCC Queue Delay and the second metric is the ITT.

DCC Queue Delay

Figure 4.23 shows the DCC Access Queue delay by using PGC via CRL and the RO. The curves of PGC via CRL are actually the same as in Figure 4.18, presented here again for comparison.

As shown in Figure 4.21 the RO coordinates with the Access DCC and is aware of the next DCC-TxOp allowed by the ‘Gate Keeper’. Consequently, as described in algorithm 1, the orchestrator wakes up at that time, compares the scores of all the applications and allocates the transmit opportunity to the application with the highest resource. The generated packet finds the DCC Access layer ‘Gate’ open and is transmitted without any queuing delay, as shown in Figure 4.23.

¹⁰[30] is still a draft

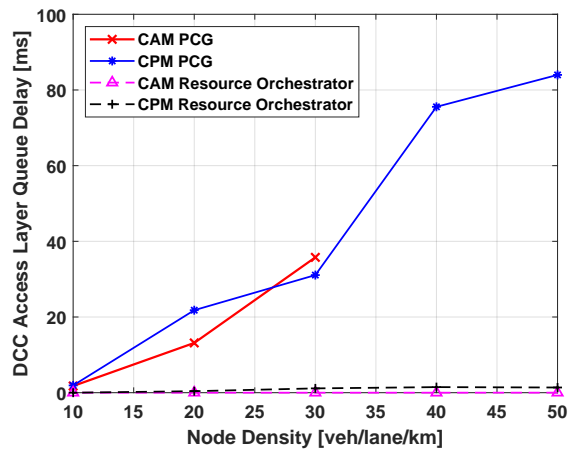
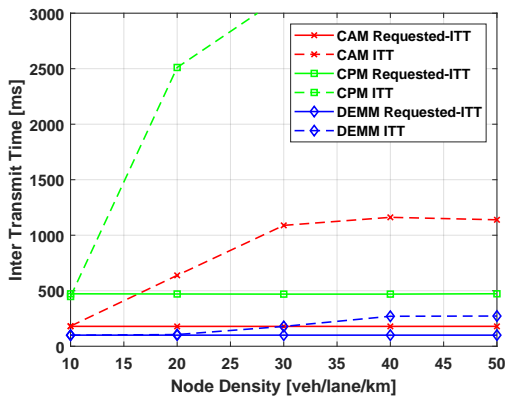
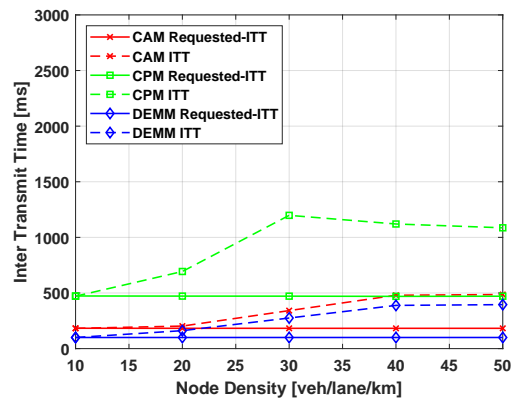

Figure 4.23: DCC Access Queue delay, using PGC vs Resource Orchestrator



(a) CRL control on top of Adaptive DCC



(b) Resource Orchestrator on top of Adaptive DCC

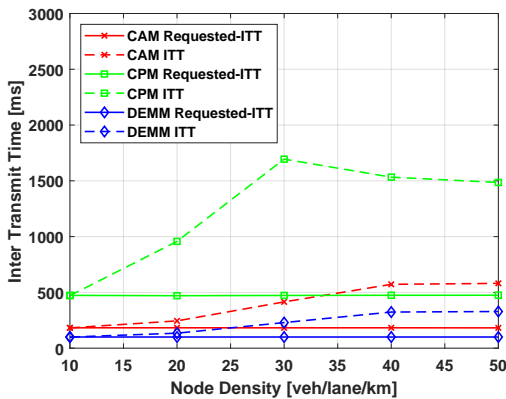

(c) Resource Orchestrator on top of Adaptive DCC with more resource for DENM

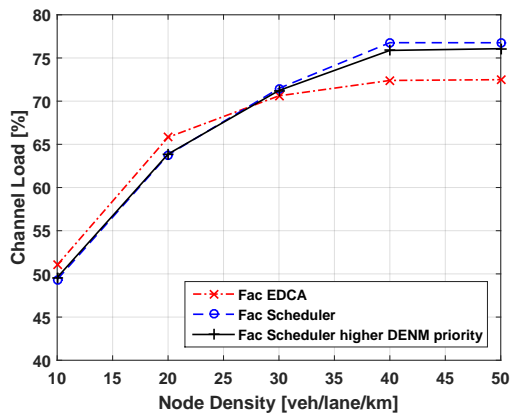

(d) Channel Load

Figure 4.24: Performance using Channel Resource Limit Control and Resource Orchestrator

Resource Orchestration among Application: Mitigating Lower priority application Starvation

We compare the performance of resource allocation to applications by PGC via CRL, which uses static TC versus the Resource Orchestrator, as presented in the earlier sub sections. For this evaluation, we use 3 applications, DENM, CAM and CPM, with TC 1, 2 and 3. The metric of evaluation is the ITT.

Figure 4.24a shows the difference in the ITT asked by each application and allowed by PGC via CRL using static TC. On average, DENM requests 100ms ITT, CAM 200ms and CPM around 500ms ITT. However, as the node density or channel load increases, the ITT increases. Above a density of 30veh/lane/km (channel load 70%), CPM is starved and the CPM ITT exceeds 3 seconds, and CAM over 1 second, while allocating 150 to 250 ms ITT to DENM. As described earlier, static prioritization is fixed and cannot be modified by PGC via CRL, highly degrading the performance of lower TCs.

However, using the RO the scheduler has much more flexibility to allocate resource among the applications. Figure 4.24b shows the ITT when each application DENM, CAM and CPM are given 50%, 27% and 23% priority using the priority values of 2.75 for DENM, 1.5 for CAM and 1.25 for CPM as in the example of Section 4.6.3. The ITT of CPM and CAM are much better than PGC via CRL. However, this comes at a cost of as much as 150ms performance degradation of DENM at higher channel loads.

Therefore, if the DENM performance is inadequate, then the resource calculation functionality can reduce the priority factors of CAM and CPM to give a higher resource share to DENM, using Eq. 1 & 2. Thus, Figure 4.24c shows the reduction in DENM ITT by around 100ms, when 60% resource share is allocated to DENM, while CAM and CPM having a reduced share of 25% and 15% respectively.

Both the mechanisms, i.e. PGC via CRL and RO produce similar loads, as in Fig 4.24d. The load increases gradually till 70%, after which it converges between 70 to 75%. In fact, limiting the channel load is the role of the Access DCC, and the Adaptive DCC used here, performs the job well. The role of the presented scheduler is to take the limit of the Access DCC and manage the transmit opportunity among the applications. Therefore, whether allocating 50% or 60% share to DENM, doesn't change the channel load.

This section concludes our analysis of the In-vehicle resource allocation i.e. dividing a vehicle's resource limit among its applications. In the next section we focus on inter-vehicle resource allocation, i.e. channel resource allocation to each vehicle as a whole, in particular when some vehicles have higher resource demand than other vehicles.

4.7 Inter-Vehicle Resource Allocation (Asymmetric resource demand by vehicles)

In this section we analyze and present our solution to the problem of DCC allocating equal channel resource to nearby vehicles facing similar channel loads, and how it can be problematic for some vehicles with higher number of applications and higher communication needs than other vehicles.

In our solution, when the channel load is near the threshold and the resource allocated to a node by DCC is insufficient to satisfy all its applications, the node can surpass the DCC allocated resource quota only for its messages of highest priority P. The burden of the surpassed resource amount is equally shared by neighboring nodes within 1-hop distance, who sacrifice quota from their messages of priority less than P. The goal is to temporarily re-allocate resource from some nodes who are transmitting low priority messages, to other nodes who have a high priority message to transmit, while keeping the channel load same. Let's use an example to clarify the concept and aid the explanation which follows.

4.7.1 Example of Distributed Resource Re-allocation

- Let's say the threshold limit of a channel is 100 msg/sec & currently 10 nodes are sending CAM of equal size at 10Hz each, totaling 100 msg/sec and fully using the channel. A 10Hz equal resource quota is allocated by DCC to each node.
- Out of those nodes, a node called A, additionally starts transmitting 10 Hz DENM, and DENM and CAM are of equal size. Using existing allocation of DCC, node A will not be able to send any CAM, as DENM will fully use the resource quota of 10Hz per node, as seen earlier.
- We propose a solution, so that when Node A transmits 10Hz DENM, which is 10% higher than the channel saturation threshold of 100 msg/sec, all the 10 nodes including node A, reduce the individual CAM transmit rate by 10%, from 10Hz to 9Hz, sacrificing 1Hz quota per node and liberating 10Hz capacity in the channel for the 10Hz DENM of node A. Analogously, if any node transmits 5Hz CAM, it will sacrifice its CAM transmit rate by 10% to 4.5 Hz.
- The new message pattern in the channel is 90Hz CAM and 10Hz DENM, accommodated within the channel usage threshold of 100Hz. Similarly, when Node A stops transmitting DENM, all nodes stop sacrificing and things return as before.
- Lastly, all the processes occur dynamically in a distributed way without any centralized control entity.

4.7.2 Resource Re-allocation Mechanism

There are 3 steps in the process, which are: i) The node with higher priority (HP) messages to transmit calculates the amount of its resource shortage as a percentage of low priority (LP) messages in the channel. To accommodate its HP messages without surpassing the channel saturation threshold, an equal amount of LP messages have to be reduced in the channel. ii) The node announces its resource shortage as the calculated percentage, inside the header of transmitted HP messages. iii) Each neighbor within a 1 hop distance transmitting LP messages, reduce their individual rate by that percentage.

The 3 steps are repeated every 100ms or its multiple, as long as the node with (HP) message has a quota shortage.

Step 1: Resource Shortage Calculation

A key component of the approach is the percentage reduction of LP messages in the channel and similarly by each node, such as 10% in the above example. It is calculated by the node demanding higher resource, which we refer to as higher priority node (HPN). The neighboring nodes who sacrifice their resource of LP messages can be referred to as lower priority nodes (LPN).

The resource quota shortage (QS) is calculated by the HPN as:

$$QS = H + L * (1 - R) - QA \quad (4.13)$$

Where QA is the quota allowed by the Access DCC, H is the resource demanded by the HPN for its HP messages, L is the resource demanded by the HPN for its LP messages, and R is the percentage of LP messages to be reduced in the channel. It is the same percentage reduction for the channel and each node within 1-hop range. It is calculated as:

$$R = \frac{QS}{LC} \quad (4.14)$$

In the above equation, LC corresponds to the total channel usage by lower priority messages from all nodes other than the HPN itself. Therefore, combining Eq. 4.13 and Eq. 4.14, QS can be obtained as:

$$QS = \frac{LC * (H + L - QA)}{L + LC} \quad (4.15)$$

In the case, where the node's allowed quota QA is fully consumed by LP messages, i.e. QA = L, then Eq. 4.15 becomes:

$$QS = \frac{LC * H}{QA + LC} \quad (4.16)$$

Thus, in the above example using Hz or msg/sec as the unit of resource, LC = 90Hz (total CAM transmitted by all nodes other than the HPN), H = 10Hz (DENM demanded by the HPN), L = 10Hz (CAM transmitted by the HPN), QA = 10Hz (quota/message rate allowed for each node). Therefore, using Eq. 4.16, QS for Node A is (90 * 10) / (10+90) = 9Hz. Similarly, using Eq. 4.14, the percentage reduction R can be calculated as: QS/LC = 9/90 = 0.1 or 10%.

As mentioned earlier, the HPN i.e. Node A repeatedly updates R and announces it inside the header of its HP messages. In the above example, for the second iteration, QS is calculated using Eq. 4.15 instead of Eq. 4.16, as the QA is 10, which is greater than L, which is 9. In the first iteration, every node including Node A, decreases 10% of LP messages, so in the second iteration the value of L is 9 for Node A. Therefore using Eq. 4.15, QA = 81(10 + 9 - 10)/(9 + 81) = 8.1 Hz. However, using Eq. 4.14, R remains the same, i.e. 8.1/81 = 0.1 or 10%. Therefore, the system remains stable if other conditions do not change, and all the nodes continue sacrificing 1Hz CAM.

However, for the HPN to use channel resource of an amount equivalent to QA + QS, it has to bypass the 'Gate Keeper' of the Access layer DCC, which allows QA resource to each node. Even if the 'Gate Keeper' functionality needs to be

bypassed, the overall channel load remains unchanged, as resource is simply ‘transferred’ from nodes with LP messages to nodes with HP messages. In other words, the total channel usage and the channel load remains unchanged.

Step 2: Announcing Resource Shortage

The percentage reduction R is calculated by the HPN, as it cannot be calculated by the LPNs, because the value of LC or amount of channel usage due to LP messages is unique to the HPN, which may not be same for all of its 1-hop neighbors due to hidden nodes and asymmetric spatial distribution of channel load and type of messages creating the channel load. As shown in Figure 4.25, Node B from its position cannot determine the 90Hz (or its equivalent percentage) value of LC for the HPN, i.e. Node A.

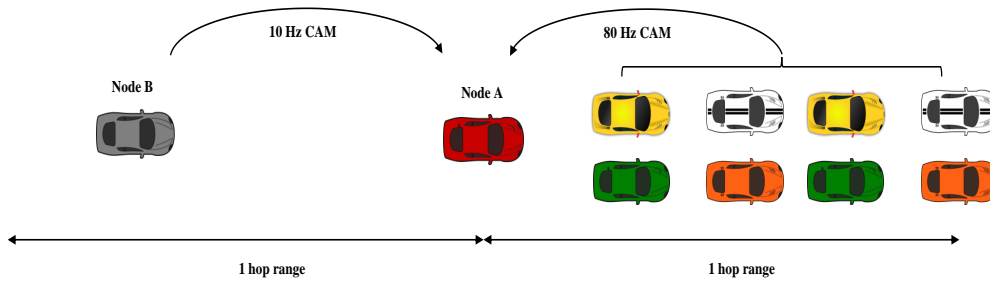

Figure 4.25: Hidden Nodes and Non-homogeneous spatial distribution of messages

Therefore, whenever the HPN faces a quota shortage, it can announce the value of R in the header of its HP messages, which acts as a control information for the LPNs to reduce the percentage of its LP messages. Although this procedure is not indicated in the standards, but an optional field can be included inside the header of emergency messages to communicate this information.

Step 3: Resource Sacrifice by Nodes with Lower Priority Messages

As long as any LP node k , receives a HP packet containing a value of R greater than 0, it sacrifices $R\%$ of resource from its LP messages. Therefore, each HPN periodically re-calculates R and announces it inside the header of the HP packets. If there are more than 1 HP neighboring nodes, the LP node k , sums up the $R_i\%$ for each of those N number of HPNs and reduces its low priority message resource quota L_k , according to:

$$L_k = \max(0, L_k * (1 - \sum_{i=1}^N R_i)) \quad i \neq k \quad (4.17)$$

If a node has no more LP messages to sacrifice, its quota of LP messages becomes 0. Additionally, if the difference of priority levels or Traffic Class, between the HP message and LP messages, i.e. $TC_{HP} - TC_{LP} > 1$, and if the node has quota for other low priority messages, then it starts sacrificing from that resource quota, as long as it has not sacrificed its share of quota of messages of priority equal to that of the HP message which is requesting the sacrifice. For example, if a node is sacrificing LP messages to allow more DENM in the channel, it first starts reducing resource quota of CPM. If the resource for CPM becomes 0, then it can reduce its quota of CAM and so on.

4.7.3 Evaluation with Static Scenario

In this sub-section we present the necessity and feasibility of asymmetric allocation using a static artificial scenario to analyze the functionality of our proposed mechanism at a granular scale. The following sub-section presents results of the usual evaluation scenario of this thesis, i.e. the 4 lane by 4 lane highway.

In this artificial scenario, there are 160 static Nodes, all visible to each other and transmit 300 Byte CAM at 10 Hz during 30 seconds. In scenario 1, there are 2 nodes out of those 160 which additionally transmit 450 Byte 10 Hz DENM between seconds 10 and 20. In scenario 2, there are 20 nodes out of those 160 which transmit 450 Byte 10 Hz DENM between seconds 10 and 20, instead of 2 DENM transmitters. Therefore, there are two types of nodes, i.e. transmitting only CAM and transmitting CAM and DENM.

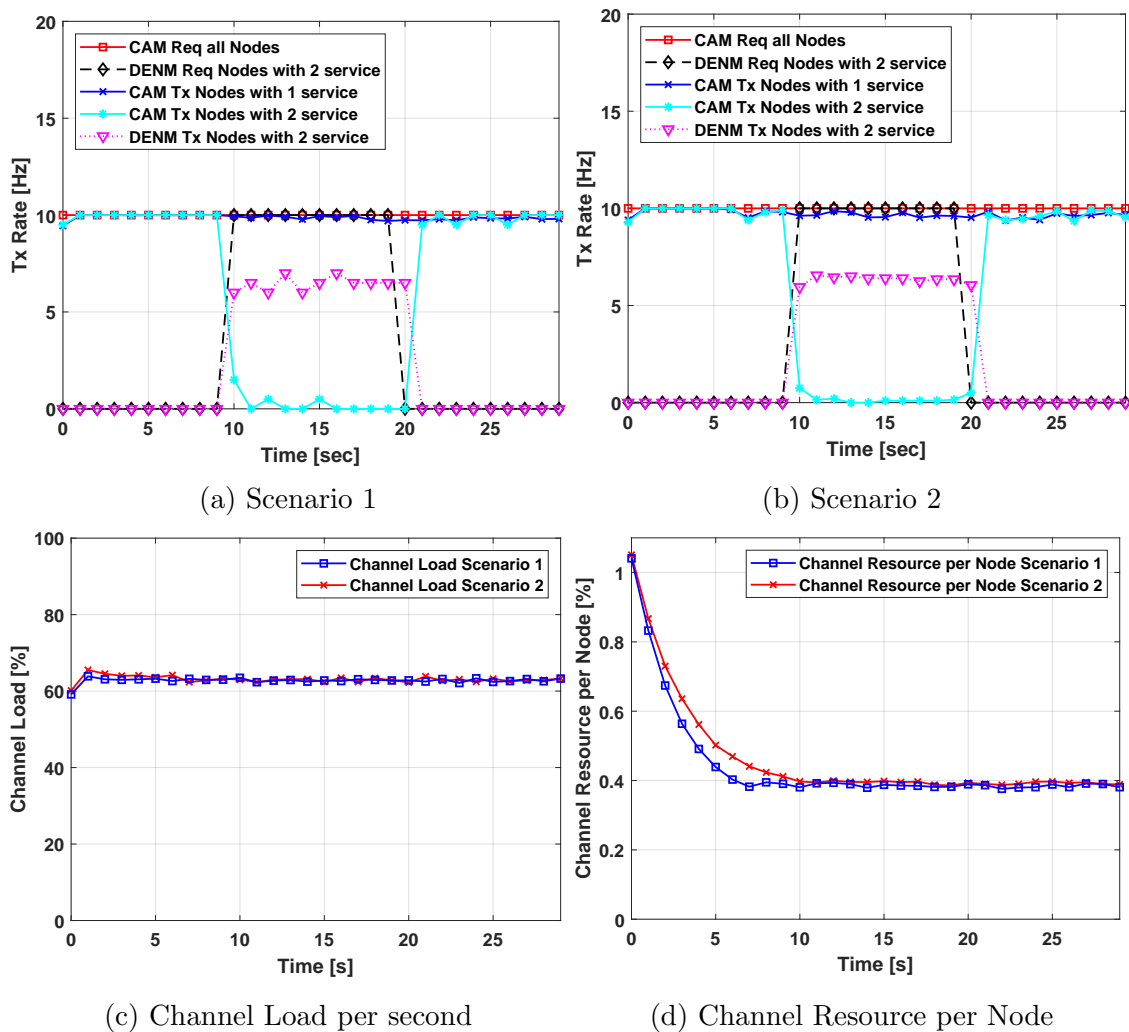

Figure 4.26: Performance of Adaptive DCC with equal resource allocation to Nodes

Figure 4.26a shows the performance of scenario 1. The first group of nodes, i.e. with only CAM demand and transmit 10Hz CAM all throughout the 30 seconds. The second group of nodes, request and transmit 10Hz CAM during the first 10

seconds. However, between 10 and 20 seconds when the nodes attempt to transmit 10Hz DENM, they can only transmit 6-7Hz DENM and no CAM at all. Exactly, the same pattern follows for scenario 2 as well, where 20 nodes transmit DENM out of the total 160 nodes.

This phenomena can be explained using graph 4.26d, which shows the resource allocation per node by Adaptive DCC. When the system stabilizes, each node is allocated 0.4% of channel resource. Considering 6Mbps datarate, 0.4% means $0.004 * 750000 \text{ Bytes/sec} = 3000 \text{ Bytes/sec}$. This resource quota can be used to transmit 300 Byte CAM at 10Hz or 450 Byte DENM at 6.67 Hz, which is exactly shown in graphs 4.26a and 4.26b. As the in-vehicle resource allocation maintains absolute priority during allocation, therefore DENM takes the totality of the resource, while CAM gets nothing, as discussed in earlier sections. However, the focus of this section is to highlight the inter-vehicle allocation and to highlight that even if one set of nodes cannot fully send its required 10 Hz DENM, the other set of nodes always send 10 Hz CAM, whereas CAM is of lower priority than DENM.

Similarly, the channel load is maintained around 64%, in both the scenarios as shown in Figure 4.26c. Therefore, this demonstrates that Adaptive DCC maintains the channel load by allocating a fixed channel resource quota per node, which does not depend on the type or the priority of the messages, or the number of applications per node.

Figure 4.27 shows the performance of the same static scenario 1 and 2, but using the resource reallocation mechanism described earlier in this section on top of Adaptive DCC. The first significant improvement is that nodes requesting 10Hz DENM are allowed to transmit them, unlike the case of using only Adaptive DCC.

In scenario 1, only 2 nodes transmit 10 Hz DENM of 450 Bytes, totaling 9000 Bytes/sec. This amount is equally sacrificed by all the 160 Nodes, who decrease their CAM transmission. However, the decrease is negligible, as the share on each node is $9000/160 = 56.25$, which is just 0.2 Hz reduction of 300 Byte CAM between 10 and 20 seconds, as shown in Figure 4.27a.

In scenario 2, 20 nodes transmit 10 Hz DENM, giving a total DENM footprint of 90000 Bytes/sec, which corresponds to 2Hz CAM sacrificed by each of the 160 nodes, as shown in Figure 4.27b. Therefore, an exact amount of channel resource is sacrificed by nodes with lower priority messages, which is fully used up by other nodes to transmit their higher priority messages without any loss of channel resource or transmit opportunity.

Similarly, the channel load is also maintained at around 64%, as shown in Figure 4.27c, as nodes only ‘transfer’ or re-allocate resource among themselves, while the total channel usage remains unchanged. However, at around 20 seconds, there is a slight dip in channel load, as it takes around 1 second for the sacrificing nodes to realize the fact that DENM are no longer transmitted, after which they continue transmitting CAM at 10Hz.

Lastly, Figure 4.27d shows the channel resource per node for Scenario 2. Adaptive DCC allocates equal amount of resource i.e. 0.4% per node. However, thanks to the asymmetric allocation, nodes with 2 services get higher channel resource, while nodes with 1 service of lower priority sacrifice their resource between 10 and 20 seconds.

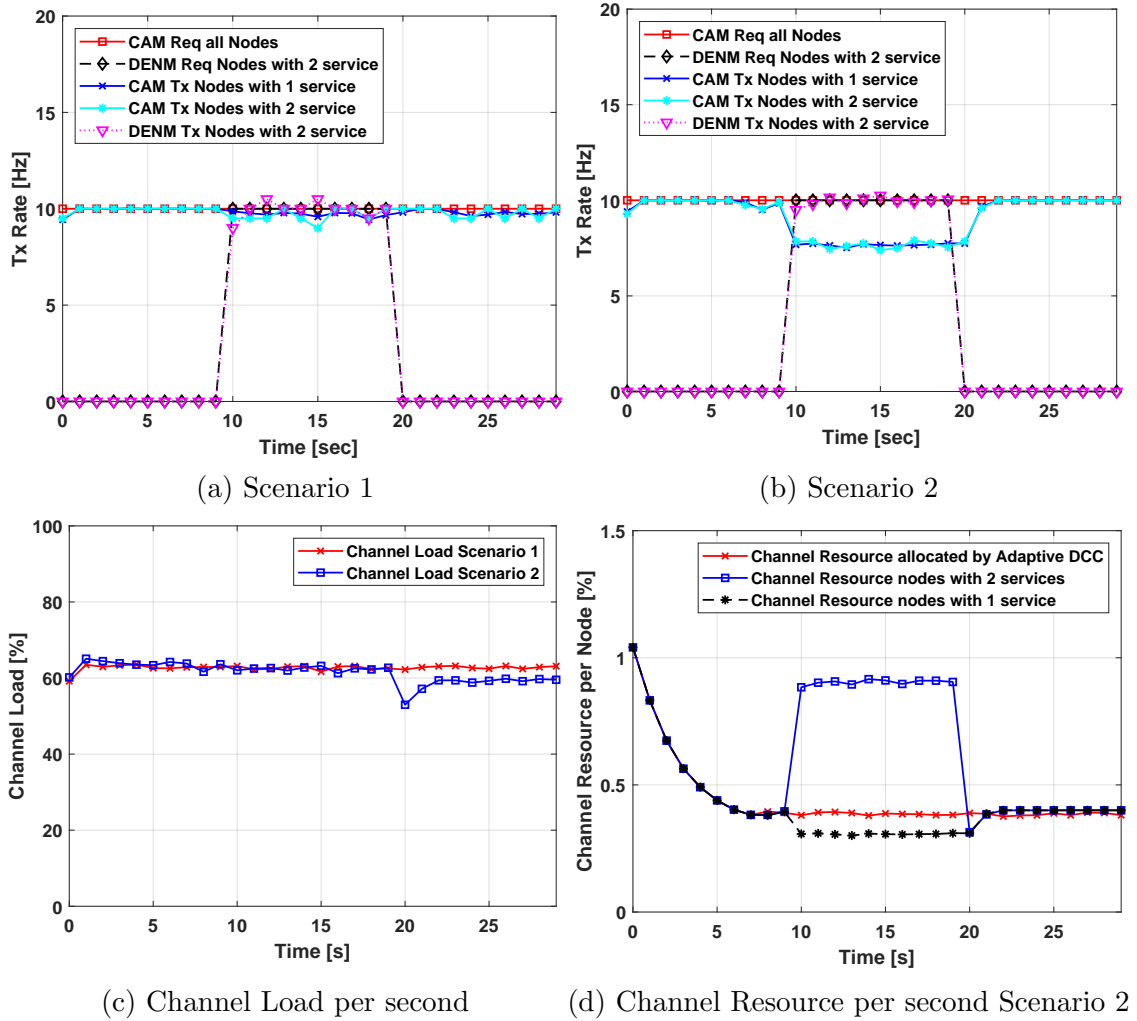

Figure 4.27: Asymmetric resource allocation, more resource to nodes with 2 services

4.7.4 Evaluation with Dynamic Scenario

In this section, we present the results of asymmetric resource allocation using the same bi-directional highway scenario as in the earlier sub-sections, with 10% of nodes transmitting DENM, in a burst of 100 DENM during a period of 10 seconds. Figure 4.28a shows the performance of the two groups of nodes, i.e. with CAM only and CAM and DENM, using adaptive DCC.

At low vehicle density and low channel load, the resource allocated to each node is sufficient to transmit 5Hz CAM and 10Hz DENM. However, from a density of 30veh/lane/km corresponding to 48% channel load, the resource allocated by Adaptive DCC is not sufficient, degrading the performance of CAM and DENM as shown in Figure 4.28a, whereas nodes emitting only CAM, always achieve the full required rate of 5Hz.

Figure 4.28b shows the performance when asymmetric allocation is used along with Adaptive DCC. Firstly, DENM always achieves the required rate of 10 Hz. At low channel load, when there is enough resource per node for 10Hz DENM and 5Hz CAM, there is no CAM sacrifice by the nodes. The sacrifice begins only from

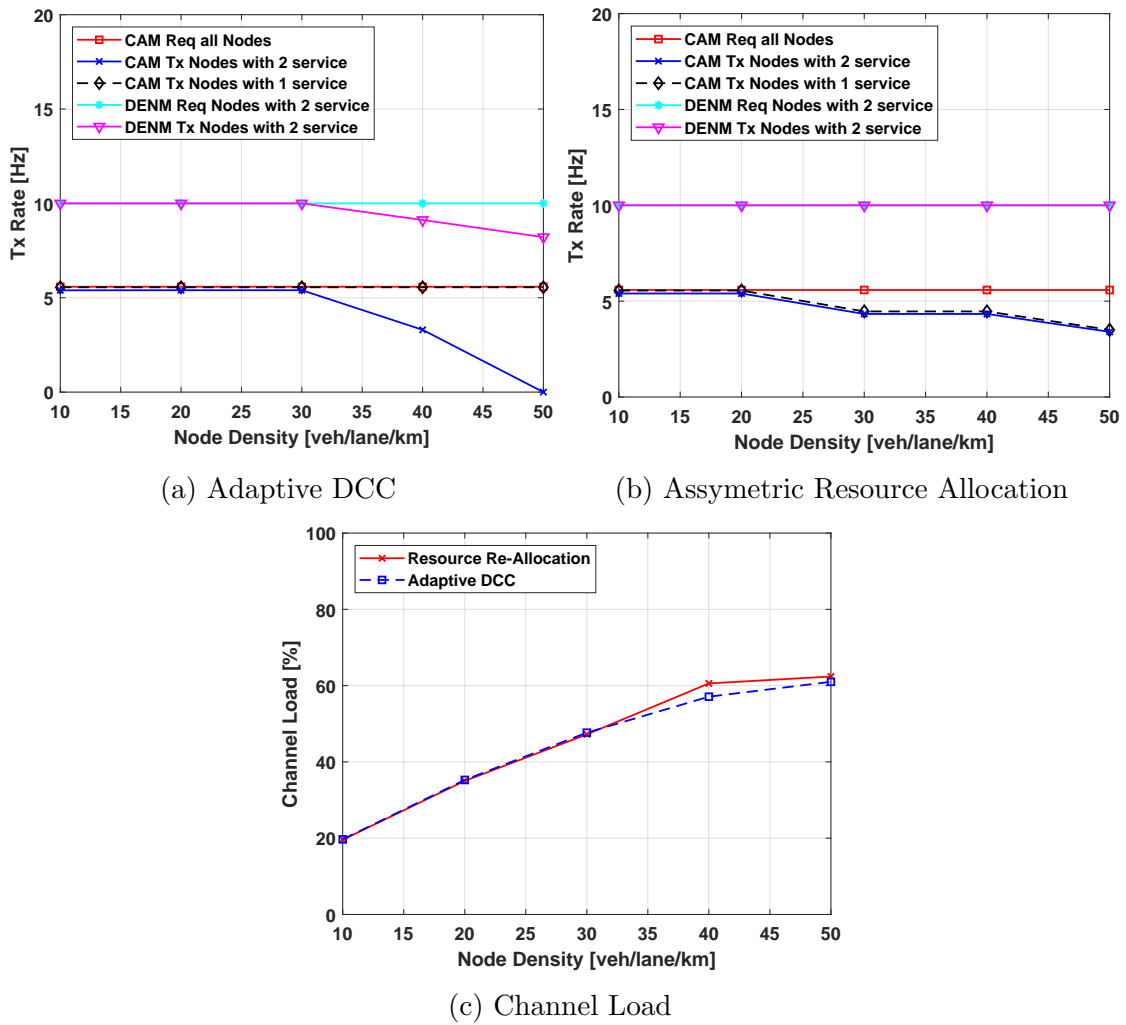

Figure 4.28: Asymmetric resource allocation, highway scenario

a density of 30veh/lane/km corresponding to about 48% channel load. Similarly, at higher channel loads, as the resource per node decreases, the CAM sacrifice per node increases to ensure the 10 Hz transmit rate of DENM.

4.8 ITS-G5 & WiFi Spectrum Sharing

In this section, we deal with a slightly different topic than the rest of this chapter. In fact the results in this chapter is to validate the relevance and necessity of all the results and analysis presented in this chapter so far.

As stated in earlier chapters, the spectrum of V2X communication in the 5.9 GHz band may not be exclusive for ITS-G5/DSRC, other than perhaps the control channel. Thus, all the previous results in this chapter so far have been dealing with how to use the control channel most efficiently for multiple safety applications. As service channels in the 5.9 GHz band may have to be shared with other technologies, communication performance may be degraded in those channels, arising the need for the control channel to be used to its maximum capacity.

Therefore, in this section we evaluate the standardized spectrum sharing protocols, and analyze whether coexistence with other technologies i.e. WiFi, indeed have a harmful effect on V2X communication or not. The spectrum sharing or coexistence protocols called Detect and Vacate (DAV) and Detect and Mitigate (DAM) Reduced and Absolute, which have been described in Chapter 2. In this section we evaluate their performance.

4.8.1 Performance Evaluation

We evaluate the DAM and DAV mechanisms on a simple urban intersection scenario with two WiFi and two ITS stations. We consider an urban scenario as WiFi is more densely deployed in cities, such as residential and commercial indoor WiFi and public outdoor WiFi hotspots. The first scenario is artificial and corresponds to the setup in Fig. 4.30 with a static ITS-G5 receiver placed at the intersection, which has been presented in chapter 3, shown here again for the ease of readability.

The WiFi nodes are in Line of sight (LOS) to the ITS stations and there is log-distance attenuation without fading. This artificial scenario is used to analyze microscopically the asymmetric detection and unilateral hidden issue between ITS-G5 and WiFi as described in Chapter 3 Section 3.2.5. The following scenario has two mobile ITS stations approaching an intersection and in LOS with WiFi, to simulate the coexistence with an outdoor WiFi hotspot. The last scenario in this Section simulates the same intersection, but with the WiFi nodes inside a building and in Non line of sight (NLOS) with the ITS stations, corresponding to indoor commercial or residential WiFi.

As with other simulations in this thesis, we use the iTETRIS simulator [109], which has a full ITS-G5 and WiFi protocol stack, which we modified to implement DAV and DAM. However, this is an urban scenario and some of the simulation settings are different. Table 4.9 lists the simulation parameters. We use the CAM Packet Reception Ratio (PRR) as the performance metric of the coexistence protocols, i.e. effective coexistence should not interfere with CAM and result in high PRR.

4.8.2 Artificial Scenario: 3 Zones of Awareness

Figure 4.29 illustrates the impact of WiFi on PRR of CAM, for various spectrum sharing protocols and traffic classes, as the ITS-G5 transmitter V1 in Fig. 3.2 approaches the WiFi AP through three zones. The negative and positive x-axis

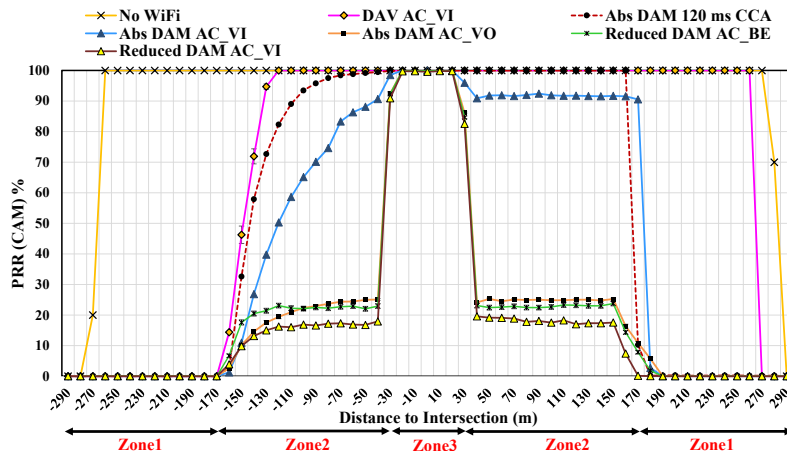

Figure 4.29: CAM PRR for 3 Zones of Awareness

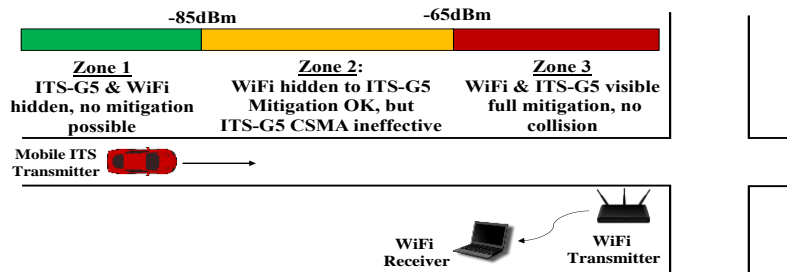

Figure 4.30: Three Zones of visibility between ITS-G5 and WiFi

values are the positions of V1 before and after the intersection respectively. The curve without WiFi has the maximum PRR as there is no interfere to the ITS-G5 communication, with minimum sensitivity of -92dBm. For all other curves, when V1 is in Zone 1 (<-170m), it is hidden from the WiFi AP, which starts detecting ITS-G5 at -85dBm, as explained in Section 3.2.5 Similarly the WiFi AP is hidden to V1 in Zone 1, due to ITS-G5 detecting WiFi at -65dBm, so PRR is almost 0.

In Zone 2, V1 becomes visible to WiFi but not vice-versa. However, the switching to DAM or DAV mode by WiFi starts only when a CAM probabilistically coincides with a WiFi non-transmission period. This probabilistic coincidence results a

Table 4.9: Simulation Parameters

Parameter	Value
Transmit Power	ITS-G5: 23 dBm, WiFi: 23dBm & 13dBm
Transmit Rate	ITS-G5: 10 [Hz] WiFi: ~300 [Hz] @ 2250 [B] 5.4 [Mps]
Packet Transmit time	ITS-G5: 0.4 [ms] WiFi: 1.5, 2 & 3 [ms]
Preamble Detection Threshold	ITS-G5: -92 [dBm] WiFi: -85 [dBm], WiFi: -65 [dBm]
Mobility	Static & 10 [m/s]
EDCA queue	ITS-G5: AC_BE WiFi: AC_VO / AC_VI / AC_BE
Fading	Scenario 1: No fading Scenario 2&3: WINNER B1 Urban Microcell (Correlated Gaussian & Ricean)
Performance Indicators	Packet Reception Ratio (PRR) (95% Confidence Intervals – 1000 runs)

gradual (not sharp) rise of CAM PRR, even if the attenuation is only log-distance without fading.

Table 4.10: Detect and Mitigate EDCA parameters

AC	CW min	CW max	AIFSN (Reduced)	AIFSN (Abs)	TXOP Limit (Reduced)	TXOP Limit (Abs)
BK	31	2047	49	2065	2528 ms	2258 ms
BE	31	2047	43	2059	2528 ms	2258 ms
VI	15	31	21	1029	3000 ms	3008 ms
VO	7	15	11	515	2080 ms	1504 ms

Unlike DAV, with DAM protocol WiFi doesn't sleep for 10s upon detecting ITS-G5, but transmits lesser than usual, using higher AIFS and backoff window, as shown in Table 4.10. Reduced DAM performs the worst in Fig. 4.29, giving only $\sim 20\%$ CAM success rate (PRR) in Zone 2. This low PRR doesn't improve much if WiFi transmits lower priority traffic of class AC_BE, so an increase in EDCA parameters for AC_BE is not significant to improve the performance of Reduced DAM. This is also the case with Absolute DAM class AC_VO, as even an AIFS of $\sim 4.6\text{ms}$ ($515 \times 9\mu\text{s}$, as shown in Table 4.10) is not enough. Absolute DAM with class AC_VI, with $\sim 9\text{ms}$ AIFS ($1029 \times 9\mu\text{s}$) performs better, but can't fully prevent CAM loss. The reason for this lack of effectiveness of DAM, even with higher AIFS, is that as the WiFi AP is unilaterally hidden to V1 in Zone 2, the long AIFS or backoff cannot guarantee that V1 will not transmit during a WiFi transmission. Nevertheless, a longer WiFi AIFS increases the probability that an ITS-G5 transmission will coincide with a WiFi non-transmission period and will not collide with WiFi.

In Zone 2, as WiFi has a better detection capability, the only way to fully prevent interference is that upon detecting the first CAM, WiFi should abstain and perform CCA **long enough** to detect the next ITS CAM. In Fig. 4.29 the curve DAM absolute EDCA (120ms fixed CCA) is a hypothetical implementation to demonstrate this aspect. In case of 100ms periodic CAM, 120ms WiFi CCA significantly improves the DAM performance. Unlike the 10s duration of DAV, DAM only lasts for 2s (if WiFi doesn't detect further ITS-G5), so WiFi returns to normal EDCA mode within 2 seconds of V1 quitting the WiFi detection range near +170m, whereas DAV continues channel vacate for 10 more seconds.

Finally as V1 enters Zone 3, WiFi is no longer hidden, so no interference may be observed. However, Zone 3 starts at 30m to the intersection, and is far too short for safety-related ITS applications. On the contrary, Zone 1 is too far away to affect such safety-related applications. Accordingly, Zone 2 remains the critical area, where DAM and DAV intend to ensure coexistence and prevent collision with ITS-G5 packets, which we analyze further in the next scenarios.

4.8.3 Scenario: Outdoor WiFi

This scenario has two ITS mobile nodes, both transmit and receive CAM at 10Hz. The channel contains fading (WINNER B1; Gaussian Shadowing & Ricean fast fading). Figure 4.32 shows the setup, i.e. an intersection without buildings to simulate outdoor WiFi.

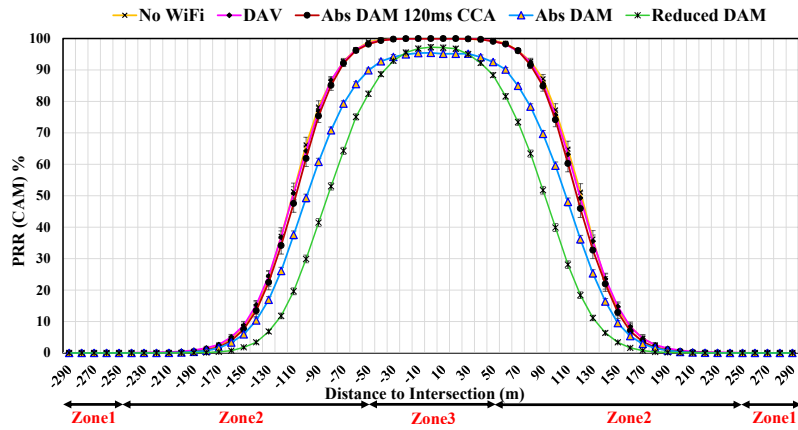

Figure 4.31: CAM PRR for Outdoor WiFi

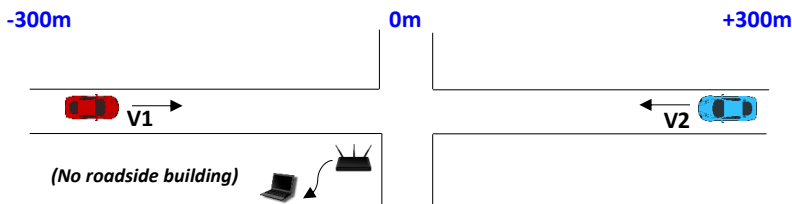

Figure 4.32: Scenario Outdoor WiFi, ITS-G5 in LOS with WiFi

Figure 4.31 shows the CAM PRR (average of V1 & V2) for various mitigation techniques for outdoor WiFi. At any point, both vehicles are equidistant to the intersection. WiFi traffic of class AC_VI is only analyzed and presented on the graph for the sake of readability.

Unlike the last scenario, the receiver is now mobile and the maximum CAM PRR is governed by the distance between transmitters and receivers. The attenuation of WINNER LOS propagation is lower than the log-distance one, so the start of Zone 2 i.e. the WiFi awareness range stretches as far as -250m.

The PRR rises gradually for the different mitigation techniques, with Reduced and Absolute DAM resulting 10%~20% CAM loss in Zone 2, compared to the curve of CAM PRR with no WiFi, and reach even closer to the curve of no WiFi in Zone 3 starting at -50m, indicating an increase in PRR. The curves of Absolute DAM 120ms CCA and DAV follow the curve of CAM PRR with no WiFi, indicating their high effectiveness in preventing interference. Therefore, we can conclude that both the coexistence protocols perform relatively well in outdoor WiFi scenario.

4.8.4 Scenario: Indoor WiFi

In this scenario, the WiFi stations are inside a building, for NLOS propagation between WiFi and the ITS stations, as shown in Fig. 4.34. With indoor WiFi, in addition to the three zones, two other factors affect the CAM PRR, i.e. is the ITS receiver within the transmission range of the ITS transmitter and is the ITS receiver within the interference range of WiFi. This aspect can be explained via points **1 to 5** on the curve Reduced DAM in Fig. 4.33.

Point 1: The ITS receiver (either V1 or V2) is outside the transmission range of the transmitter (either V1 or V2), so low PRR due to strong attenuation (ir-

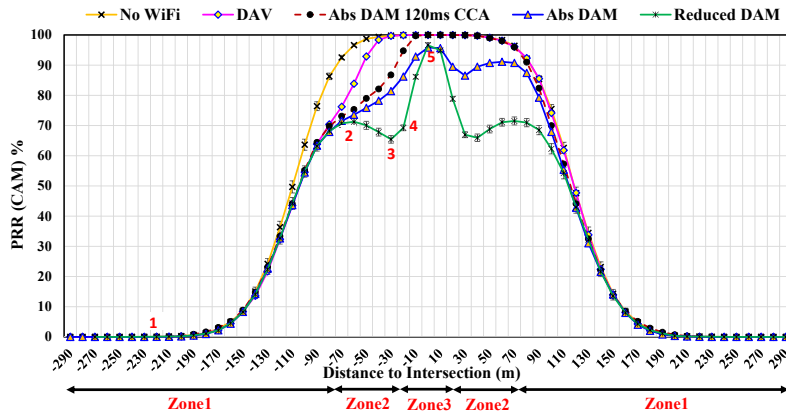

Figure 4.33: CAM PRR for Indoor WiFi

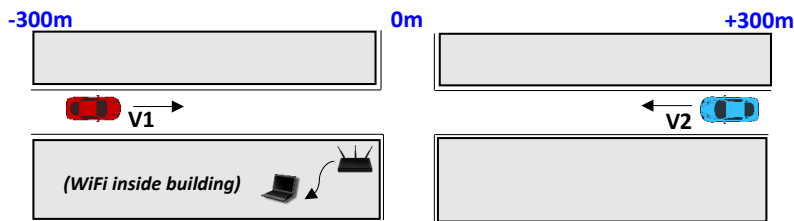

Figure 4.34: Scenario Indoor WiFi, ITS-G5 in NLOS with WiFi

respective of WiFi). **Point 2:** The CAM PRR rises as the mobile ITS receiver comes inside the transmission range of the mobile ITS transmitter. Zone 2 starts at -70m and WiFi begins to detect ITS-G5, but Reduced DAM cannot fully prevent interference in Zone 2, as discussed earlier. **Point 3:** Unlike outdoor WiFi, the PRR doesn't always increase in Zone 2, but there is a dip in PRR as the ITS receiver moves more and more inside the interference range of the WiFi AP, i.e. the SINR of received CAM decreases due to stronger interference from WiFi. This is the point of highest interference at around -30m . **Point 4 & 5:** The ITS stations move closer to the WiFi nodes and detect WiFi signal above -65dBm in Zone 3 at around -20m , causing a sharp rise in PRR.

Compared to outdoor WiFi, Zones 2 and 3 start later for Indoor WiFi as the awareness range of WiFi is attenuated by the walls. ITS stations have to come nearer and overlap with a WiFi non-transmission period, in order for WiFi to detect ITS-G5 signal above -85dBm and apply DAM or DAV. Zone 2 starts at -70m , and different mitigation techniques vary in their level of performance, following the same trend as before. DAV gives the highest CAM PRR, followed by Absolute DAM 120ms CCA, then Absolute DAM and finally Reduced DAM produces the highest interference so lowest PRR.

This decrease in awareness range of indoor WiFi for detecting ITS stations and vice versa in NLOS condition is a significant challenge, regardless of the mitigation protocol. Reduced & Absolute DAM both create significant interference in Zone 2, and even DAV causes interference, while 100% PRR is achieved not until Zone 3.

One aspect to notice is that beyond the generated interference, one may notice their spatial scales. All WiFi induced interference occurs in Zone 2, at distances below 70m for indoor WiFi, which corresponds to 3-5s drive time for 70km/h and 50km/h respectively. In both cases, that would lead to a too short detection time

by any mobile vehicle to avoid a potential impact, which is not acceptable and needs to be improved.

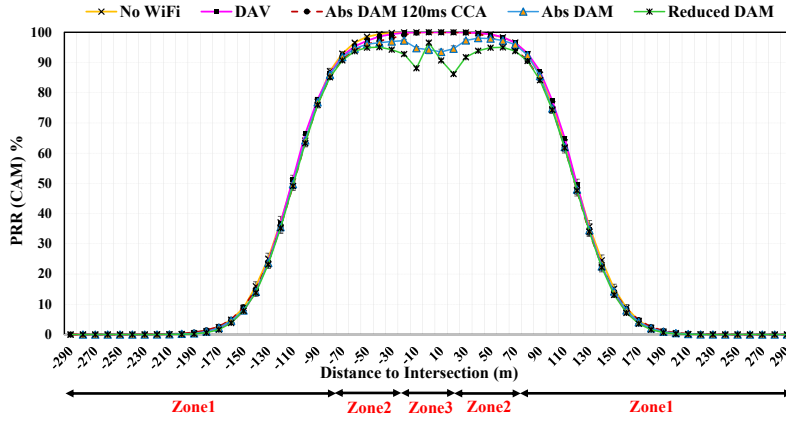

Figure 4.35: CAM PRR for Indoor WiFi Reduced Power

Proposal - Reduce WiFi Transmit Power: One possible solution to counter loss of awareness from indoor WiFi is to decrease the WiFi Tx power. The CAM PRR for lower WiFi power i.e. 13dBm instead of 23dBm, is shown in Fig. 4.35. WiFi induced interference follow similar trends for Absolute and Reduced DAM, but at a significantly higher CAM PRR compared to Fig. 4.33.

Similarly at reduced power, DAV does not generate almost any interference with ITS-G5. This is a clear indication that a reduction in WiFi power for indoor WiFi might be necessary to mitigate interference with ITS-G5. The impact of such Tx power reduction on the WiFi performance remains to be evaluated, but is out of the scope of this thesis, as we focus on ITS-G5 and it is not the role of ITS-G5 to maximize the performance of WiFi when using ITS-G5 channels.

Chapter 5

Conclusions and Discussion

In this chapter we recall the problems addressed in this thesis, summarize the findings and discuss their limitations and implications for V2X communication. Similarly, we also present some future perspectives and directions for extending the work.

Our focus in this thesis has been analyzing and proposing improvements to Decentralized Congestion Control and channel Resource Allocation protocols standardized by ETSI in Europe for safety V2X communication. These standardized protocols have been designed for initial V2X communication scenarios, a.k.a Day 1 deployment, considering mainly a single type of message for Cooperative Awareness. Whereas in future deployment or Day 2 scenario, vehicles will transmit a variety of messages, while the capability and channel resource requirement will be heterogeneous among the vehicles. We evaluated DCC protocols for multiple V2X safety messages in the same channel and heterogeneous resource requirement by the vehicles and found out shortcomings with existing DCC design and protocols.

5.1 Summary of Problems Addressed and Contributions

In the first section of this chapter, we recall the problems addressed in this thesis and present a summary of the findings. In the second section we discuss some directions for future work.

5.1.1 DCC Access

Firstly, we evaluated the performance of DCC for transmit rate control of multiple applications at the Access layer. Access DCC is of two types, i.e. Reactive and Adaptive. Reactive DCC controls the transmit rate by mapping the channel load to Transmit Rate Limit via a state machine. We analyzed and found several issues with different aspects of Reactive DCC.

Firstly, the rate control is too severe, which limits the transmit rate from as low as 30% channel load. Thereby, these strict rate limits proposed in the standards do not allow any channel usage over 50% capacity, even if the node density increases,

thus throttling transmit rate and hindering communication performance, even if ample channel capacity remains available. Moreover, the adaptation of transmit rate to channel load is non-optimal causing transmit rate oscillation resulting in an unstable control process.

Therefore, we improved Reactive DCC by proposing less severe rate control parameters, starting at 40% channel load, which is able to limit the channel load to 70% with as high as 300 vehicles in a single hop communication range of one another, moving at a speed of 70-90km/h.

Similarly, we mitigated the rate oscillation of Reactive DCC by implementing a continuous smooth channel resource adaptation function and a first order filter, instead of abrupt rate oscillation via a state machine, which further improves its performance.

Lastly, Reactive DCC limits the transmit rate without considering the packet size or packet air-time which makes it incompatible for transmitting multiple types of messages. This is because using the same channel resource quota a node can send more small packets or few large ones. Transmit rate limit without considering packet size does not allow this flexibility. Therefore, we modified the unit of Reactive DCC from transmit rate limit to channel resource limit, which makes it more adapted to handle multiple packets with variable packet size, and makes it compatible with any higher layer DCC entity managing the channel resource share per service/application. The channel resource is essentially the percentage of channel a node is allowed to use regardless of the packet size. We use this unit for inter-vehicle resource allocation among the vehicles and in-vehicle resource allocation among the applications of a vehicle.

We also analyzed the other variant i.e. Adaptive DCC, which uses channel capacity much more than Reactive DCC giving better application performance. However, we found issues with the overall DCC design for managing multiple applications per vehicle and heterogeneous number of applications among the vehicles, even by using Adaptive DCC.

5.1.2 DCC Queuing and Traffic Shaping

Whether Reactive or Adaptive rate control, DCC performs traffic shaping via queuing and flow control at the upper MAC layer, using an additional layer of queuing on top of EDCA queues. DCC prioritizes transmit opportunity among the applications using static Traffic Classes, giving absolute priority to a higher TC over a lower TC. During high channel load or channel resource shortage, an application belonging to a lower TC is indefinitely starved.

The DCC queue size is limited and generally chosen to be 1, in order for a newer packet to erase an older packet waiting in the queue and itself be transmitted as it contains more up to date sensor information. Therefore, to mitigate the aforementioned problem of starvation due to static TC, if two services are put in the same DCC queue, then a service can erase the packet of another service.

Similarly, the service with the higher packet generation rate contends better and gets better QoS. The problem persists using a multi layer LIFO queue, where a service with higher packet generation rate pushes the packet of another service backwards which eventually gets dropped, after a limited Time To Live. On the other hand, the packet age in a queue increases with higher channel load, and the

queuing delay is higher for a multi layer queue than a single layer queue, whereas information inside transmitted packets should be up to date for safety V2X applications. These factors make it difficult for the node to ensure QoS per application, degrading the performance of safety V2X applications during channel congestion.

To summarize, the two major problems of DCC queueing is that QoS cannot be controlled as a per application basis and during channel congestion, the queues delay packets as much as around 80 ms or even more for some DCC combinations, for a channel load of 70%. Additionally, there is also a CSMA channel access delay, (which has not been analyzed in this thesis.) Whereas V2X safety applications need up to date information and the lower the Inter Transmit Time the better it is, in terms of information quality such as positioning error/uncertainty.

We do not attempt to solve the problem of queuing, as the Access layer doesn't have sufficient knowledge about the applications and the node's communication context and requirements. Instead we focus on moving the traffic shaping intelligence from the Access to the Facilities layer.

5.1.3 Design and Cross Layer Issues

In order to mitigate the problem of DCC queuing, one approach is to control the packet generation with respect to the channel load, and avoid generating excess packets at the Service/Facilities layer, as excess would queue up in the DCC queues due to limited transmit opportunities during channel congestion. In this regard, two functionalities at the Service/Facilities layer have been proposed in the ETSI standards.

We refer to the first mechanism of controlling the packet generation at the Facilities layer as Packet Generation Control (PGC) via Transmit Rate Limit (TRL), which maps the channel load to the minimum packet generation interval for each Traffic Class. This inter packet generation interval w.r.t DCC are called as T_GenCam_DCC and T_GenCpm_DCC in the standards.

The second mechanism, which we refer as Packet Generation Control (PGC) via Channel Resource Limit (CRL), takes the channel resource limit for the node calculated by Access DCC, and divides it as CRL per application, prioritizing applications via static Traffic Class, similar to Access DCC.

However, these two mechanisms cannot fully avoid the DCC queue delay due to several design problems. Firstly there is no synchronization between the PGC and the exact DCC Access transmit opportunity, resulting in some queue delay of the generated packet. Secondly, there is no coordination among the PGC process of different services, causing a lack of arbitration in allocating the next DCC transmit opportunity. Similarly, PGC via CRL allocates channel resource to applications based on static TC, which starves lower priority TC during channel resource shortage. Therefore starvation is not only a problem of Access DCC queuing, but it originates from the design principle of giving absolute priority to one static TC over another.

We tested the two PGC mechanisms on top of Adaptive and Reactive DCC, and Table 5.1¹ summarizes the performance of each combination in handling the issues due to DCC cross layer design. As can be seen in the table, all the 4 combinations fail to tackle most of the issues. In this regard, we propose a resource orchestrator

¹already presented in Chapter 4, presented here again for the ease of readability

Table 5.1: DCC Cross Layer Issues solved by the proposed Resource Orchestrator

	PGC TRL+ Reactive	PGC TRL+ Adaptive	PGC CRL + Adaptive	PGC CRL + Improved Reactive	Proposed Orchestrator + Adaptive
Synchronize Access with Facilities packet generation	No	No	No	No	Yes
Coordinate packet generation opportunity among applications	No	No	No	No	Yes
Eliminate DCC queue delay	No	No	No	No	Yes
Avoid DCC queue packet erasing of one application by another	No	No	No	No	Yes
Maximize channel capacity usage	No	Yes	Yes	Yes	Yes
Flexible & Dynamic resource allocation among applications eliminating starvation	No	No	No	No	Yes

at the Facilities Layer, which succeeds in handling the problems arising from the DCC cross layer design.

5.1.4 Resource Orchestrator

We proposed a resource orchestrator which characterizes each application/service using multiple dynamic factors instead of static TC. These factors dynamically determine what proportion of a node’s resource should be allocated to each application. As the factors are dynamic, it ensures that no application is indefinitely starved during resource constraints. Similarly, the orchestrator maintains a memory and implements functionalities for keeping track of the resource earning and spending by each application, instead of the existing ‘fire and forget’ design of DCC.

Above all, the orchestrator functions in coordination with the ETSI Access DCC. After transmitting each packet, the orchestrator is informed about the next DCC transmit opportunity. At that next DCC-TxOp, the orchestrator updates the resource stock of each application and schedules a packet from the application having the highest resource.

The design of the orchestrator solves two problems simultaneously. Firstly, the cross layer interaction is synchronized between Access DCC and packet generation at the Facilities layer. Secondly, the orchestrator arbitrates the allocation of DCC transmit opportunity among the applications. Thus, queuing delay is negated as well as the problem of one application erasing packets of another application in the DCC queues.

5.1.5 Inter-Vehicle Asymmetric Resource Allocation

Another problem addressed in this thesis is that DCC measures the channel load by calculating the number of slots busy during an observation window. However, this does not reflect the priority of the communications producing the channel load. Consequently, nodes facing similar channel load, are allocated equal channel resource. Whereas, in Day 2 V2X deployment, some nodes will have more applications than others and will need a higher proportion of channel resource than others.

Using DCC we demonstrated that when a node has to transmit packets from several applications, but the resource is sufficient only for one application, the lower priority application is completely starved. Whereas, nearby nodes even if transmitting only lower priority packets, can fulfill their entire requirement, while the node with two applications get only half of their required amount of resource. Although DCC provides a mechanism for a node to temporarily send a burst of highest priority DENM once every 10 seconds using a token bucket, but that mechanism is only for messages in the highest priority TC, and is not scalable for other TCs.

To mitigate this problem of asymmetric resource demand we designed a distributed protocol to re-allocate resource to a node with higher priority messages facing a resource shortage. To prevent the increase of channel load due to this excess amount allocated, all the nodes sharing the channel sacrifice a small resource quota from their lowest priority message, which sum up to the excess resource re-allocated to the node with higher priority message. Similarly, whenever the resource scarcity ends, things return to normal in a distributed manner without any centralized resource allocator. Simulation based evaluation shows the feasibility of this approach and highly improves the performance of nodes with asymmetric resource demand during channel congestion.

5.1.6 Spectrum Sharing

In this thesis, we also analyzed the spectrum sharing on the 5.9 GHz ITS band, highlighting the challenges of coexistence between IEEE 802.11p and WiFi. Our findings show that coexistence can be challenging, while some spectrum sharing protocols perform better than others. Above all, the main challenge is for WiFi devices to detect the presence of ITS-G5 signal, which can be non-trivial depending on the environment, thus creating harmful interference for ITS-G5 communication.

We identified 3 zones of awareness relevant for coexistence, and found that at short distances between ITS transmitter and receiver, there isn't much problem of coexistence. At long distances, there is high ITS packet loss due to interference from WiFi, but long distances are not critical for safety related ITS applications. At medium distances, outdoor WiFi can coexist better than indoor WiFi, the latter creating non-negligible ITS CAM loss which can be problematic for ITS safety applications. We demonstrated that reducing indoor WiFi transmit power significantly improves the performance of the proposed coexistence protocols.

We observed that the coexistence protocol Detect and Mitigate faces performance issues, and we showed that one way to improve its performance is that upon a single ITS-G5 packet detection, the WiFi channel non-usage time and CCA should be at least similar to the periodicity of ITS-G5 packets, in order to detect the presence of further ITS-G5 packets.

The CCA duration and abstention period can be optimized and adapted by WiFi through a cognitive process and we will look into this in our future work. We will also look into the effect of WiFi interference on ITS applications, such as the impact on braking distance and other safety applications.

Nevertheless, the challenges of coexistence affirms the relevance of the other contributions in this thesis, i.e. efficiently managing multiple applications on a single channel. Most probably, the Control Channel will remain exclusive for ITS-G5 communication. This brings the need for the Control Channel to be utilized to

the maximum, requiring the need for efficient in-vehicle and inter-vehicle resource orchestration for multiple V2X messages in the same channel.

5.2 Future Work

Many of the contributions in this thesis are a first approach in the domain and there are several possibilities for extending the work, providing the way for new research challenges which we discuss in this section.

5.2.1 In-vehicle resource allocation

Service Characterization factors

We designed a modular resource orchestrator which characterizes each application using dynamic factors, and calculates the resource share and keeps account of the resource earning/spending of each application, and synchronizes the scheduling with the Access layer DCC. Although the design and the functionality of the orchestrator has been detailed in this thesis, but the service characterization can be further developed.

We provided examples of 3 parameters for service characterization, i.e. Rank, Usefulness and Urgency. These metrics need to be further developed, establishing their dynamic relations with a vehicle's requirement and knowledge of the environment. For example, to determine the usefulness of a service like Collective Perception, which disseminates the information collected by the sensors of a vehicle, a publish subscribe mechanism can be defined. Thereby a communication which has more subscribers, can have a high usefulness value.

Similarly, more complex mechanisms to determine the value of the information for the neighboring nodes from the viewpoint of the sender needs to be developed. In this regard, a recent study [110] proposes computing the value of the detected objects and determines whether or not to transmit a Collective Perception Message. Thus any application communicating information with a high value for the most number of neighbors, should have a high usefulness than others.

Another recent study [111] evaluates the redundant transmissions of Collective Perception Message by neighboring nodes who detect the same event. Similarly, this factor can add to the usefulness metric, such as a lower information redundancy increasing the usefulness of the information and vice versa.

We designed the orchestrator to be modular, which leaves room for developing the prioritization of the services, such as implementing value based networking or other dynamic traffic characterization functionalities. However, the interaction of the orchestrator with the Access DCC functions can remain unchanged, regardless of the service characterization method.

Extension of the contributions to other technologies: LTE-V2X

As indicated in the Introduction chapter, LTE-V2X has entered into the V2X communication ecosystem much later than DSRC/ITS-G5, and channel congestion control mechanism for LTE-V2X Mode 4 has been introduced in 3GPP Release 14

specification. It works similar to Reactive DCC, which maps the CBR to Channel occupancy ratio (CR) for the node.

As the approach is similar to Reactive DCC, a recent study [112] has found rate control oscillation for LTE-V2X DCC. Therefore, the improvements we have proposed in this thesis for Reactive DCC, can be attempted for LTE-V2X DCC to stabilize the rate control oscillation.

Another major issue found out in the study [112], is that the LTE-V2X DCC produces lower packet delivery ratio compared to using no DCC at all, at high channel loads. This is due to an incompatibility between the LTE-V2X DCC rate control mechanism of packet dropping and LTE-V2X resource reservation via semi-persistent scheduling. Therefore, in such a scenario a resource orchestrator is surely necessary to respect the constraints of the PHY layer and schedule the application packet generation, instead of generating excess packets which may get dropped.

Compared to ITS-G5/DSRC, DCC for LTE-V2X can be challenging, in particular for multiple applications with variable periodicity and packet size. This is because for LTE-V2X, the point in time the resource is reserved is fixed and the amount of resource reserved is also fixed until the next reservation or canceling the current reservation and making a new one. However, for ITS-G5/DSRC, DCC rate control only sets the lower bound i.e. minimum Inter Transmit Time between two transmissions without a maximum. Therefore for LTE-V2X, if the applications themselves are left to generate packets without an orchestrator/arbitrator, it can surely degrade performance, which will be evaluated in our future work, along with extending our application layer resource orchestrator for LTE-V2X radio access technology.

5.2.2 Dynamic prioritization for Inter-vehicle resource allocation

We proposed a mechanism for allocating excess resources to vehicles with higher priority messages compared to other vehicles sharing the channel, in particular when the channel resource is insufficient to transmit those higher priority messages. This excess resource amount is sacrificed by the vehicles with lower priority messages in the channel.

We tested using static TC, for example vehicles sacrifice their CAM (TC 2) transmissions, when other vehicles transmitting DENM (TC 1) face resource shortage. However, if the resource amount to be sacrificed by a vehicle keeps on increasing, it may happen that the lower priority application is being starved. Therefore, dynamic application prioritization has to be implemented in this mechanism, similar to the mechanism we proposed for In-vehicle resource allocation.

Consequently, nodes will not reduce quota based on the TC, but using the priority value of the vehicle requesting excess resource compared to the priority of its own messages. However, system stability may be affected by too many dynamic factors, which is simplified when using static TCs. Similarly, vehicles need to have a common system of measuring the priority, in order to compare the importance of neighbor's messages versus ego-messages. These interesting challenges will be dealt in our future work.

5.2.3 Network Slicing for DSRC/ITS-G5

Network slicing is a hot topic, which has gained popularity in recent years to be implemented in 5G networks. The actual definition of a network slice varies on the part of the network and on the use case. According to one paper [113], a network slice is referred to as a collection of core network and radio access network functions whose settings are configured to meet the diverse requirements. As a simple interpretation, slicing basically involves reserving a network's capacity for ensuring constraints demanded by particular services. For V2X communication, although slicing has received attention regarding LTE-V2X, but implementing the concept for ITS-G5/DSRC is yet to be investigated.

Thus, our proposed inter-vehicle resource allocation can be extended for slicing the IEEE 802.11 radio access network. As mentioned earlier, DCC and our resource allocation works on top of 802.11 CSMA medium access. Therefore the unit of resource is the percentage of channel usage or duty cycle, without considering the CSMA channel access delay.

Using this definition of resource, a specific channel capacity or 'slice' can be reserved for a particular application having a particular priority, and only vehicles with a packet to transmit of that application can be allocated capacity in that slice. Similarly, if the capacity of a higher priority slice becomes insufficient, it can be dynamically increased by shrinking the slices of lower priority services.

All these possibilities will be investigated in our future work.

5.2.4 Machine learning for resource allocation

Machine learning is being currently used for various aspects of V2X communication and channel resource allocation can highly benefit from machine learning, for learning and predicting a vehicle's channel resource requirement and availability, and thus enabling better resource allocation and reservation among the applications.

The resource orchestrator presented in this thesis allocates resource as the demand comes, i.e. based on the latest calculation of the priority values. However, during highly dynamic channel conditions, it may happen that currently the channel resource is constrained while more capacity will be liberated in the near future. In such a context, an application with higher priority can be allowed to use higher proportion of a node's current resource, temporarily pausing other lower priority applications. Consequently, when the channel load reduces in the near future, the lower priority applications can be allowed to transmit their packets.

This requires learning the transmissions of neighboring nodes, and predicting the availability of channel resource. The channel load can be influenced by a lot of factors such as, the communication scenario, traffic density, road topology, vehicle mobility pattern, types of applications using the channel etc. Simultaneously, the ego vehicle's resource requirement pattern has to be predicted, i.e. the future transmission demand of the vehicle's applications, allowing resource reservation based on demand and supply.

As the number of factors affecting the channel load, i.e. the number of features to learn can be quite a lot, the task is not trivial. Nevertheless, we attempted a first approach to learn neighbors' transmission pattern on a rather stable scenario, using time series prediction to predict and avoid concurrent transmissions and collisions with hidden nodes. The results have been put in the Appendix of this thesis.

Thus for future work, we plan to extend the machine learning approach for application resource orchestration.

Appendices

Appendix A

Machine Learning for V2X message prediction

A.1 Introduction

Vehicle to Vehicle (V2V) and Vehicle to Infrastructure (V2I) communications are being deployed with a goal to improve traffic safety and transport efficiency. Initially a majority of the vehicular safety applications were only based on improving a vehicle's awareness of its vicinity by exchanging with its neighbors its position, speed, heading through periodically broadcasting Cooperative Awareness Messages (CAM) or Basic Safety Messages (BSM). Further along the road, V2X communication will be used for cooperative driving and navigation, when a variety of messages will be transmitted, as intelligent vehicles will negotiate and coordinate their maneuvers. This will require more reliable V2X communication mechanisms.

Among several potential wireless communication technologies, the technology being currently commercially available is called ITS-G5 in Europe and DRSC in the USA, with standardized PHY and MAC layers based on IEEE 802.11p.¹ In the ad-hoc mode of IEEE 802.11p, no centralized channel resource management is available. Each node is granted access in a stochastic way using a CSMA/CA mechanism. However, advanced applications such as Autonomous Driving and other Safety-V2X services will need highly reliable communication, which CSMA/CA-based medium access of IEEE 802.11p is not capable of providing. As the channel load increases, the communication performance of CSMA/CA also rapidly degrades, further affecting the performance of critical V2X services.

Wireless congestion control has been designed to prevent channel saturation, enabling each node to periodically monitor the channel load and adjust its transmit rate and power. However, collisions still occur due to the stochastic nature of CSMA/CA and near-far effects. As safety-V2X services mostly rely on broadcast traffic, packet collisions due to probabilistic channel access or due to hidden terminals can neither be detected nor fully avoided. Yet, what if an intelligent vehicle could precisely anticipate and predict neighboring vehicles' transmission, and accordingly orchestrate its own transmissions?

We address the possibility for a vehicle to learn, predict and transmit channel

¹The 3GPP LTE-V2X mode 4 is a promising alternative technology. Due to its ad-hoc nature, it bears similarities regarding the challenges discussed in this chapter, and is expected also to benefit from the approach proposed in this chapter.

activities in order to avoid packet collisions. Assuming a vehicle can learn the transmit patterns from 1-hop neighbors, it can precisely know the channel activity rather than sensing it. Thus, each node will know much better when to transmit and to avoid collisions with its neighbors. Moreover, if such a vehicle further shares such predicted channel activity with its 1-hop neighbors, it would enable farther away vehicles to learn the transmit patterns of hidden nodes. Accordingly, this would let each vehicle better orchestrate its transmissions, not only based on the slots used by its 1-hop neighbors, but also considering slots initially sensed ‘idle’ via carrier sense, but actually being occupied by hidden neighbors.

In a static and highly synchronous system, this can be easily optimized by coordinating the transmissions from different nodes. However, safety V2X communication scenarios are far from synchronous. They are rather highly dynamic, with aggressive node mobility, a varying neighbor density, a fluctuating channel load and subject to events triggered packet transmissions. In this regard, machine learning can be a useful tool for an intelligent vehicle to learn and predict its neighbors’ transmit patterns for an optimized resource orchestration.

In this chapter, we propose a novel approach to avoid packet collisions by learning and predicting neighboring transmissions using Recurrent Neural Networks (RNN) with Long and Short Term Memory (LSTM). Our contributions are three-fold: (i) we highlight the challenges of ITS-G5 to sense idle resources in time and space. (ii) we propose a machine learning mechanism using deep neural network for learning and predicting neighbors’ transmissions. (iii) using simulation based evaluation, we demonstrate that resource orchestration according to predicted channel activities can significantly reduce packet collisions and improve communication performance of safety V2X applications.

The rest of the chapter is organized as follows: Section II discusses resource management and corresponding issues in IEEE 802.11p based vehicular networks. Section III presents our intelligent scheduling via machine learning. Section IV provides performance evaluation results, followed by a brief review of the state of the art in Section V. The conclusion and future work are discussed in Section VI.

A.2 Resource Management in IEEE 802.11p based Vehicular Network

Medium Access: The medium access of ITS-G5 and DSRC is based on IEEE 802.11 standards, where there is no centralized channel resource scheduler and each node acts in a decentralized way to contend for channel access. It employs a CSMA/CA listen before talk approach, i.e. if the channel is sensed free for a certain time the node transmits directly, otherwise the node chooses a random back-off window, which decreases each time the channel is sensed free. Transmission occurs when the countdown reaches zero. The random back-off value between 0 and CW is chosen to avoid simultaneous channel access by multiple nodes.

Transmit Rate Control: In CSMA/CA, when a unicast packet is not acknowledged, the contention window is increased. This reduces channel congestion by distributing the transmission attempts over a longer period. However, safety related vehicular communications involve packet broadcast without acknowledgments, so

this contention window increase mechanism is not possible. To counter this problem, on top of CSMA/CA, there is additional flow control to limit the transmit rate of each node and reduce channel congestion. This mechanism is also known as Decentralized Congestion Control, or DCC in European Standards. Similarly in the USA, SAE has standardized a channel congestion control algorithm in SAE J2945/1 [37].

A.2.1 Issues with existing Approaches

Stochastic Medium Access: CSMA/CA attempts to minimize concurrent channel access by several nodes using a random back-off window, usually of a size between 0 to 15 slots. However, it is still probable for two nodes to obtain the same back-off window or same remaining back-off. Identical back-off results in simultaneous transmissions and collisions.

Lack of Spatial Resource Reuse: The presence of hidden nodes beyond the Carrier Sense range cannot be detected via Carrier Sense. This results in packet collisions and significantly deteriorates the communication performance as the node density increases. CSMA/CA cannot rely on spatial channel usage information beyond the Carrier Sense range. For example, if hidden nodes could transmit during different time slots, it could mitigate the problem of hidden node collisions.

Lack of a notion of Orchestration:The goal of CSMA/CA is to attribute channel access in a stochastic way to avoid concurrent transmissions by several nodes. Additionally during high channel load, transmit rate control limits the transmit rate of each node to prevent channel saturation. However, neither CSMA/CA nor transmit rate control aim to schedule or uniformly distribute the nodes transmissions along the time axis in a coordinated manner.

Channel Load calculation Granularity: Along the time axis, there can be periods of higher channel footprint during transmission bursts, when more nodes will contend for channel access. Although most transmissions are periodic or quasi-periodic during initial vehicular network deployment, some vehicles will have more advanced capabilities in the future. These vehicles will transmit multiple packets with different transmit patterns, which will result in variations of the channel footprint. This is impossible to observe by the present channel load measurement mechanisms. In the standards, the average channel load is calculated and smoothed using a FIR filter [101] over a 100ms window, while the vehicle is unaware of the granular channel activity during this window. This will degrade communication performance for future deployment scenario, involving heterogeneous and multiple safety applications per vehicle.

A.3 Intelligent Scheduling via Machine Learning

In this section, we present a learning node, which learns the channel activity during an observation window of 100ms and predicts neighbors' packet transmissions, packet size, type and the channel footprint for the next few windows of 100ms. The goal is to use the learned patterns of neighbors' packets to schedule one's own

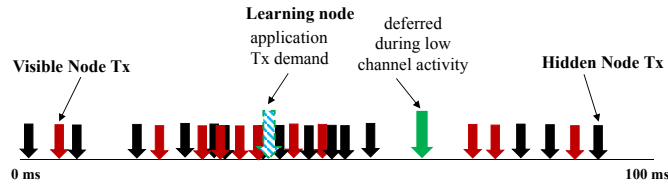

Figure A.1: Transmission deferred to period of low channel activity

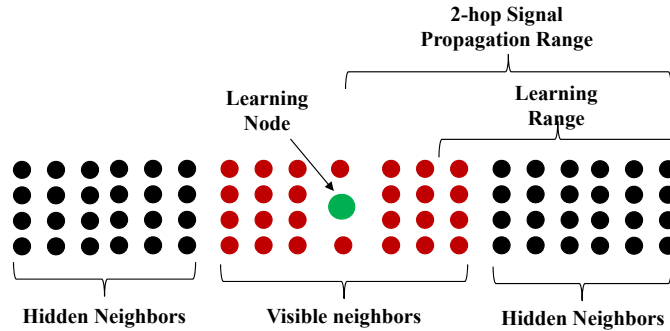

Figure A.2: Learning Distance of Intelligent Node

packets, depending on the application deadline, during periods of low or no channel activity, as shown schematically in Fig. A.1.

The figure shows a typical prediction pattern of a learning node, predicting the time instances when neighbors will transmit during the next 100ms. The dotted arrow indicates that an application of the learning node needs to generate a packet at a certain point. However, according to the prediction pattern, a period of low channel footprint will be available in the current prediction window. Consequently, the application defers the packet generation and eventually generates and transmits the packet during a period of lower channel activity.

The tolerated delay of deferring a packet depends on the application requirement. The goal is to decrease the probability of concurrent transmissions, and avoid interfering with visible and hidden neighbors, while remaining within the packet transmission deadline requirement of the application.

The learning node monitors all received packets from visible neighbors and uses the packet reception history to predict its neighbors' future transmissions. Furthermore, each node piggybacks the packet reception pattern of its own neighbors, i.e. Neighbor ID, type of packet and reception time, inside the packets it transmits. Thanks to this piggybacking, the awareness of the learning node is extended and it becomes aware of the transmit patterns of hidden nodes as well. Although piggybacking adds extra transmission overhead in each packet, it is out of the scope of this current work. In future work we intend to analyze this overhead and increase the efficiency and scalability of such piggybacking.

Nevertheless, the number of neighbors a learning node can keep track of and predict their transmissions is limited. If a learning node has to keep track of a large number of neighbors, such as in a scenario of high vehicle density, it becomes difficult to find vacant slots to schedule its own transmissions.

The set of 1-hop visible and 2-hop hidden neighbors that a learning node can keep track of has to be chosen optimally. Figure A.2 shows a schematic scenario of learning during a high node density. In the figure, the green point indicates

the learning node, the red points indicate the nodes visible to the learning node and the black points are the hidden nodes. In such scenario, the learning node prioritizes learning and predicting the transmit patterns of hidden nodes 2-hops away. As detailed in the next section, collisions due to hidden nodes play a more significant role in degrading communication performance, while potential collisions due to visible nodes are largely prevented by CSMA/CA.

A.3.1 Machine Learning for Predicting Neighbors' Transmissions

For predicting vehicular message transmissions, we use time-series prediction using RNN with LSTM. There are many algorithms for predicting sequential data, the earliest algorithm being AutoRegressive Integrated Moving Average (ARIMA). For most use cases, ARIMA or Hidden Markov Models (HMM) have become deprecated and have been replaced by RNN, for reasons outlined in [114].

The algorithms used to train HMM and vanilla RNN struggle to deal with many different inputs and to capture long term dependencies. For predicting messages from neighboring vehicles, the consequence would be that the influence of older messages on the current prediction would be ignored. LSTMs were designed to overcome this issue as discussed in [115]. For these reasons, we decided to use RNN with LSTM.

In terms of performance, deep learning is not an overkill in this use case, as the neural network is not that big and does not generate a large overhead. In this work, we look at a simplified approach of using a time-series prediction for packet transmit patterns, for which other simpler machine learning technique could be enough. However, for future work, we will consider more advanced features, such as the impact of the CSMA/CA back-off window or cellular V2X slot allocation pattern, realistic node mobility model, signal propagation and channel model, or even the impact of wireless congestion control. Deep learning will be required to learn the complex interactions between these features.

A.3.2 Design of the Predictor

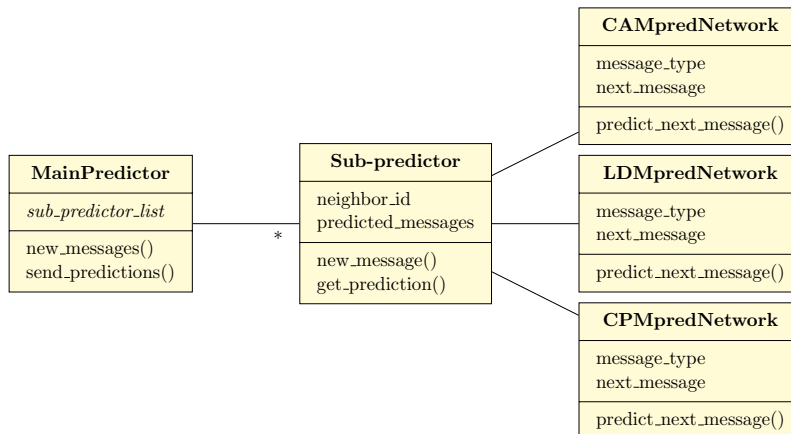

Figure A.3: Predictor Architecture

In order to predict messages from neighboring vehicles, the learning vehicle uses a *divide and conquer* approach. It maintains a sub-predictor instance for each neighbor, and predicts the neighbor’s future packets based on the previous ones. The predictor is trained off-line, using the typical communication pattern of a vehicle. The sub-predictor uses one RNN for each type of packet.

The organization of the prediction program can be seen in Fig. A.3. The main predictor keeps an active instance of the sub-predictor for each of the current neighbors. The sub-predictor handles all the packets received from a particular neighbor. It uses them to predict the next packet of each type from that neighbor. When a new packet is received by the sub-predictor, it pre-processes the packet to obtain the information used by the neural network and then feeds it to the corresponding neural network.

Periodically, every 100 milliseconds, the learning node inquires the predictor for the predicted packets for the next 100ms. The main predictor iterates through all the active instances of the sub-predictors to fetch packet predictions, and returns a complete list of future packet transmissions and the packet air time. After a time-to-live, if no more packets are received from a neighbor, the corresponding sub-predictor instance is deleted. This means that the neighbor has moved out of the learning node’s communication range and is no longer relevant.

Although the learning node feeds the predictor and inquires future packet pattern every 100ms, the sub-predictors also consider older messages during prediction. The sub-predictors do not explicitly save the older messages, but the LSTMs have an internal state that acts as a memory, and the information needed for future predictions are saved in this state.

A.3.3 Features selection and preparation

The learning node predicts three types of packets transmitted by each neighbor, i.e. motion-event triggered and periodic Cooperative Awareness Messages (CAM), event triggered bursts of Cooperative Perception Message (CPM) and periodic exchange of High Definition Maps between vehicles, using a message called Local Dynamic Map (LDM). These packets are further explained in the next section.

For each type of packet, a separate neural network is used. Each neural network receives as input the time interval between the currently received packet and the previous packet of the same type from a particular neighbor. Conceptually, this means that the interval to the next packet is predicted using the interval between the two previous packets.

CAMs are triggered by a change in a vehicle’s speed, direction or position, and the values of speed, direction and position of the CAM sender are contained inside the CAM. Values of vehicle dynamics and their gradients are also fed into the neural network. All these input features are normalized before being fed to the RNN. We use feature scaling to map the values between -1 and 1.

A.4 Evaluation

We perform a simulation based evaluation to demonstrate the communication performance improvements achieved by learning and predicting neighbors’ transmissions, and orchestrating transmissions during periods of low channel usage.

We analyze the effectiveness of our machine learning method in reducing collisions through the transmissions of visible nodes within 1-hop distance, and hidden nodes beyond the range of carrier sense (i.e. within 2-hop range). The Packet Reception Ratio (PRR) by all neighbors of the learning node as function of the distance is the primary metric of our performance evaluation.

A 10km long dense highway scenario is used, consisting of 50 vehicles/lane/km and 3 lanes in each direction. Vehicles move at speeds between 20 to 45 m/s, following a Gauss-Markov mobility model. The simulator used is called iTETRIS [116], which has a full ITS-G5 protocol stack implemented on top of NS-3.

We consider 3 types of packets (i) CAM (periodic 10Hz and motion triggered), (ii) CPM (bursts) and (iii) LDM (periodic). The European standard ETSI EN 302 637-2 [3], specifies that CAMs are generated as a function of changes in vehicle dynamics, either a 4m variation in position or a 4 degree change in heading or a 0.5m/s difference in speed. We also consider CAM transmitted at 10Hz, as a comparison point to Basic Safety Messages (SAE J2735 [41]) transmitted in the US at 10Hz. The CAM size is fixed to 300 Bytes.

CPMs are being standardized in ETSI TS 103 324 [28], and are triggered upon detection of new sensor data or road objects. In our simulation, CPMs are triggered following an uniform random distribution, where 5 messages are emitted in burts within 500ms. Unlike CAMs, CPMs are not mandatory and only vehicles with appropriate object detection capability will generate them. Thus, in our simulation, we only consider 50% of the nodes to emit CPMs with a fixed size 500 Bytes.

Lastly LDM as described in ETSI TR 102 863 [117], are messages intended to exchange HD maps data between cars. In our simulations, we considered LDMs to be emitted at 1 Hz with a fixed size of 750 Bytes. Each node starts transmission following an uniform random distribution, including a small jitter of 500 μ s during transmission of each packet. The results are averaged over 50 simulation runs with 95% Confidence Interval.

For machine learning and prediction, the LSTM with RNN have been imple-

Table A.1: Simulation Parameters

Parameter	Value
Transmit Rate	CAM: 10 [Hz] & Triggered CPM: 5 [Hz], LDM: 1 [Hz]
Transmit Power	20 dBm
Packet Size	CAM: 300 Bytes, CPM 500 Bytes LDM: 750 Bytes
EDCA Packet Priority	CAM: Best Effort, CPM & LDM: Background
DataRate	6 Mbps
Mobility	3 by 3 lane 10 km highway Speed 20 to 45 [m/s] Gauss Markov, Memory level 0.95 Sampling period 0.1 [s]
Node Density	50 vehicles/lane/km
PHY and MAC	ITS-G5 802.11p in 5.9 GHz (10 MHz Control Channel)
Attenuation	Log Distance Path Loss
Preamble Detection Threshold	- 95 dBm
Neural Network	4 layers: 40, 50, 60 neurons & LSTM unit layer
Training	Off-line, ADAM algorithm Stochastic gradient descent
Performance Indicators	Packet Reception Ratio 50 runs, 95% Confidence Interval

Table A.2: Average Channel Load for different transmit Patterns

Transmit Pattern	Average Channel Load
10 Hz CAM	65.35 %
Triggered CAM Higher Speed	50.74 %
Triggered Lower Speed	35.47 %
CAM + CPM	52.10 %
CAM + CPM + LDM	66.90 %

mented in tensorflow. The neural network consists of 4 hidden layers, with 40, 50 and 60 neurons and a LSTM unit layer. Without loss of generality, the configuration of the the neural network has been chosen empirically for this use case, to keep it large enough to capture the complexity of the data, and small enough to be trained efficiently.

The training is done using the ADAM Optimizer, with stochastic gradient descent. The batch size is 1 in order to capture the time dependencies between the packets. The training is done off-line using packets logged during simulation runs on highway scenarios. The prediction is done on-line during the run time as the learning node receives transmissions from its neighbors. Table A.1 summarizes the main simulation parameters.

Figure A.4 shows the Packet Reception Ratio (PRR) on the y-axis by the neighbors of the learning node when vehicles emit 10Hz CAMs, producing an average channel load of 65.35% as shown in Table A.2. The x-axis corresponds to the distance between the learning node and the receiving nodes.

As it can be seen, the case with no learning performs worse compared to when a node transmits according to predicted transmissions of its visible and hidden neighbors. The reception performance is improved a bit by predicting and avoiding concurrent transmissions with 1-hop visible neighbors. However, the performance improvement is the highest, when the learning node predicts the transmissions of hidden nodes. This indicates that collisions with hidden nodes play a more significant role than visible nodes in performance degradation .

Nevertheless, when the learning node predicts the transmissions of both 1-hop visible and 2-hop hidden nodes, the performance reduces a bit compared to the case with learning only hidden nodes. In the simulations, within a distance of

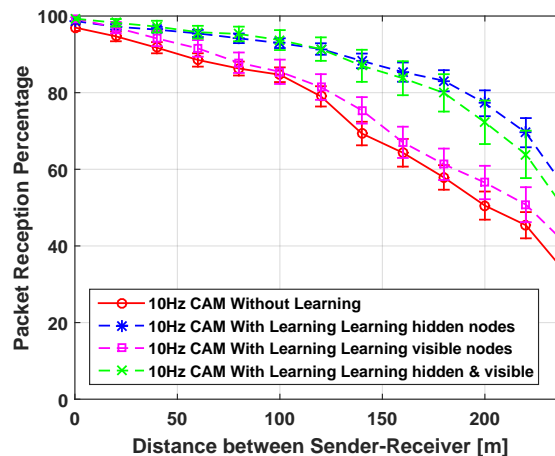

Figure A.4: Packet Reception Ratio of 10 Hz Periodic CAMs

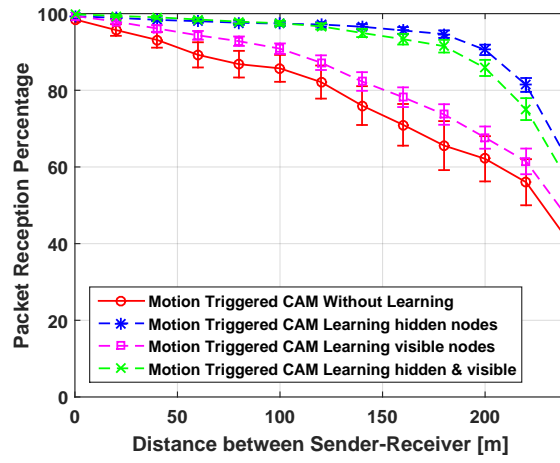

Figure A.5: Packet Reception Ratio of Triggered CAMs for vehicle speed of 35-45 m/s

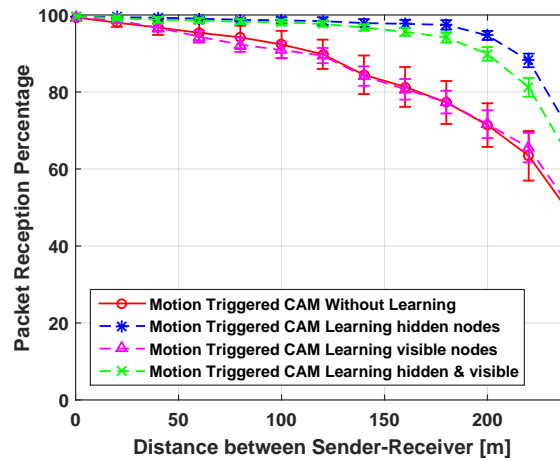

Figure A.6: Packet Reception Ratio of Triggered CAMs for vehicle speed of 20-30 m/s

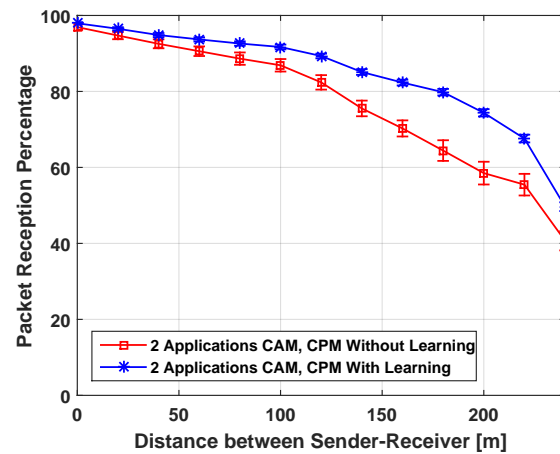

Figure A.7: Packet Reception Ratio of Two Applications CAM and CPM

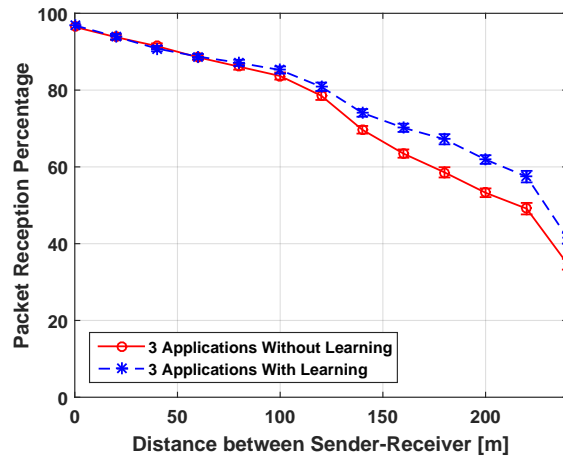

Figure A.8: Packet Reception Ratio of Three Applications CAM, CPM, LDM

a 2-hop signal propagation range, approximately 280 nodes in total are spread across 500m in both directions. In an attempt to avoid concurrent transmissions with such a high number of nodes, the learning node cannot find enough vacant periods to schedule its own transmissions before the packet TTL, and thus transmits immediately. Nevertheless, transmitting to avoid concurrent transmissions with only hidden nodes, produces an improvement of respectively 10% and 25% PRR at distances of 100m and 200m.

Figure A.5 shows the PRR when CAMs are triggered according to vehicle dynamics. Compared to 10Hz transmission, the PRR is higher, as a velocity between 35 to 45 m/s triggers CAMs between 5 and 10Hz creating a lower channel load of 50.74% compared to a 65.35% channel load produced by the earlier 10Hz periodic CAMs scenario. A lower channel load results in lesser collisions, giving a better PRR. The trend is similar, i.e. learning only hidden nodes' transmissions performs the best, followed by learning both hidden and visible nodes, then learning only visible nodes. As expected, the no learning case performs the worst.

This trend continues when the channel load gets even lower at 35.47% for a velocity of 20-30m/s as shown in Fig. A.6. However, at a low channel load of 35.47%, collisions with visible nodes are almost negligible, therefore learning transmissions of visible nodes only, provides no improvement. At a distance of 200m, learning induced PRR improvements is around 30% and 35% for channel loads of 50.74% and 35.47% respectively (i.e. for CAMs triggered at high and low speeds).

In addition to a single CAM application, we analyze the packet reception performance when 50% of the nodes emit Cooperative Perception Messages (CPM) to broadcast their sensor information. The PRR is shown in Fig. A.7, when the learning node predicts the pattern of its hidden neighbors only and transmits accordingly. CPM being larger than CAMs, the combined CAM and CPM transmissions generate an average channel load of 52.1%.

However the reception performance improvement due to learning and predicting is less than the case with only CAMs. Unlike CAMs, CPMs are triggered randomly and 5 packets are emitted in a burst, making it difficult to predict the first packet of the burst. The prediction error degrades the orchestration performance, thus affecting the packet reception ratio. Nonetheless, the learning induced PRR improvements is 5% at 100m, and 18% at 200m respectively.

Lastly, Fig. A.8 shows the PRR, when the nodes transmit 750 Bytes LDM packets along with CAMs and CPMs, producing a higher average channel load of around 66.9%. However, as the channel load increases, the performance improvement due to learning is less compared to the previous scenarios at lower channel loads. As mentioned before, at high channel loads, the learning node cannot find sufficient vacant windows of low channel activities to orchestrate its own packets before the application TTL, and thus transmits immediately. Nevertheless, at high channel load, the transmit rate control mechanism of the ETSI DCC is supposed to be activated to prevent such channel saturation, which has not been considered in this work. As part of our future work, we will investigate the behavior of the learning node along with transmit rate control at high channel loads.

A.5 Conclusion

In this chapter, we have shown that using recurrent neural network, a *intelligent* vehicle can learn and predict the transmit patterns of its neighbors. This knowledge can then be used to orchestrate its own transmissions during periods of low channel activity, leading to improved packet reception. In particular, our deep learning aided resource orchestration showed to be able to perform best on detecting and avoiding collisions with hidden nodes. We further showed that recurrent neural networks can also learn the transmit patterns of multiple V2X messages, such as CAM, CPM and LDM altogether, and are able to provide a more efficient resource orchestration than a plain CSMA/CA scheduler.

Quite a few open challenges yet remain ahead. Firstly, piggybacking creates redundancy and extra transmission overhead, which has not been analyzed in this work. Moreover, in a scenario with multiple learning nodes, the intelligence of each learning node has to be coordinated with other learning neighbors, also in a decentralized manner. Similarly, the global performance in a hybrid scenario consisting of a varying percentage of learning nodes, i.e. some nodes having learning capability, while other nodes do not, has to be investigated. Last but not the least, transmit rate control has to be incorporated with learning, which with no doubt will impact the learning efficiency. These are left to future work.

Bibliography

- [1] “C2c-cc about c-its,” <https://www.car-2-car.org/about-c-its>.
- [2] ETSI, “Etsi ts 102 637-2 v1.1.1-intelligent transport systems (its); vehicular communications; basic set of applications; part 2: Specification of cooperative awareness basic service,” 2010.
- [3] —, “EN 302 637-2 v1.4.1-intelligent transport systems (its); vehicular communications; basic set of applications; part 2: Specification of cooperative awareness basic service,” 2019.
- [4] “Cooperative driving maneuvers, perception, and ivc,” <https://materials.dagstuhl.de/files/18/18202/18202.LarsWolf.Slides.pdf>.
- [5] ETSI, “TS 102 687: Decentralized congestion control mechanisms for intelligent transport systems operating in the 5 ghz range, v1.2.1,” 2018.
- [6] “iTETRIS project,” http://wiki.ict-itetris.eu/index.php/Main_Page.
- [7] C. . C. C. Consortium, “C2c-cc distributed congestion control (dcc) for day one. version 1.0. car 2 car communication consortium, dec. 2013.”
- [8] ETSI, “En 302 636-4-2 intelligent transport systems (its); vehicular communications; geonetworking; part 4: Geographical addressing and forwarding for point-to-point and point-to-multipoint communications; sub-part 2: Media-dependent functionalities for its-g5 v1.1.1,” *ETSI EN*, 2013.
- [9] “ANNEX 2, ANNEX to the commission delegated regulation supplementing its directive 2010/40/eu of the european parliament and of the council with regard to the provision of cooperative intelligent transport systems,” <http://www.europarl.europa.eu/cmsdata/161222/Delegated%20Regulation%20C-ITS%20Annex%202.pdf>.
- [10] ETSI, “TS 102 687: Decentralized congestion control mechanisms for intelligent transport systems operating in the 5 ghz range, v1.1.1,” 2011.
- [11] “Global status report on road safety 2018,” https://www.who.int/violence_injury_prevention/road_safety_status/2018/English-Summary-GSRRS2018.pdf.
- [12] W. Dabbous and C. Huitema, “Prometheus: Vehicle to vehicle communications,” Research Report, INRIA-Renault collaboration, Tech. Rep., 1988.

- [13] M. Schulze, “Chauffeur—the european way towards an automated highway system,” in *Mobility for everyone. 4th World Congress on intelligent Transport Systems, 21-24 October 1997, Berlin. (Paper No. 2311)*, 1997.
- [14] W. Franz, R. Eberhardt, and T. Luckenbach, “Fleetnet—internet on the road,” in *8th World Congress on Intelligent Transport Systems ITS America, ITS Australia, ERTICO (Intelligent Transport Systems and Services—Europe)*, 2001.
- [15] A. Festag, G. Noecker, M. Strassberger, A. Lübke, B. Bochow, M. Torrent-Moreno, S. Schnauffer, R. Eigner, C. Catrinescu, and J. Kunisch, “‘now—network on wheels’: Project objectives, technology and achievements,” 2008.
- [16] G. Vivo, “The safespot integrated project: An overview,” in *2007 IEEE Intelligent Vehicles Symposium*. IEEE, 2007, pp. 14–14.
- [17] M. N. Mariyasagayam, H. Menouar, and M. Len, “Geonet: A project enabling active safety and ipv6 vehicular applications,” in *2008 IEEE International Conference on Vehicular Electronics and Safety*. IEEE, 2008, pp. 312–316.
- [18] T. Leinmüller, L. Buttyan, J.-P. Hubaux, F. Kargl, R. Kroh, P. Papadimitratos, M. Raya, and E. Schoch, “Sevecom—secure vehicle communication,” in *IST Mobile and Wireless Communication Summit*, no. POST_TALK, 2006.
- [19] “Comesafety, year=2009, howpublished = ”<http://www.ecomove-project.eu/links/comesafety/>.”
- [20] “Preparation for driving implementation and evaluation of c2x communication technology,” <http://www.pre-drive-c2x.eu/>.
- [21] D. C. Consortium *et al.*, “Drive c2x—accelerate cooperative mobility,” 2012.
- [22] H. Aniss, “Overview of an its project: Scoop@ f,” in *International Workshop on Communication Technologies for Vehicles*. Springer, 2016, pp. 131–135.
- [23] C. Little, “The intelligent vehicle initiative: advancing” human-centered” smart vehicles,” *Public Roads*, vol. 61, no. 2, pp. 18–25, 1997.
- [24] “Vehicle safety communications project,” <https://www.nhtsa.gov/DOT/NHTSA/NRD/Multimedia/PDFs/Crash%20Avoidance/2006/Vehicle%20Safety%20Communications%20Project%20-%20Final%20Report.pdf>.
- [25] S. J. Row, “Intellidrive: safer, smarter, greener,” *Public Roads*, vol. 74, no. 1, 2010.
- [26] C. Nowakowski, S. D. Gupta, D. Vizzini, R. Sengupta, C. Mannasseh, J. Spring, J. VanderWerf, A. Sharafsaleh *et al.*, “Safetrip 21 initiative: networked traveler foresighted driving field experiment, final report.” California. Dept. of Transportation. Division of Research and Innovation, Tech. Rep., 2011.
- [27] J. Sayer, “Connected vehicle safety pilot,” 2010.

- [28] ETSI, “ETSI DRAFT TS 103 324 (2018),” *Intelligent Transport Systems (ITS); Collective Perception Service*.
- [29] —, “Etsi ts 103 561 intelligent transport systems (its); vehicular communication; basic set of application; maneuver coordination service,” 2014.
- [30] DRAFT, “ETSI TS 103 141 “intelligent transport systems,” *Facilities Layer; Communication Congestion Control*, 2018.
- [31] ETSI, “Intelligent transport systems (its); vehicular communications; geonetworking; part 4: geographical addressing and forwarding for point-to-point and point-to-m ultipoint communications; sub-part 2: Media-dependent functionalities for its-g5,” *ETSI TS*.
- [32] —, “TS 103 175 intelligent transport systems (its),” *Cross Layer DCC Management Entity for operation in the ITS G5A and ITS G5B medium, v1*, 2015.
- [33] A. Autolitano, C. Campolo, A. Molinaro, R. M. Scopigno, and A. Vesco, “An insight into decentralized congestion control techniques for vanets from etsi ts 102 687 v1. 1.1,” in *Wireless Days (WD), 2013 IFIP*.
- [34] G. Bansal, B. Cheng, A. Rostami, K. Sjoberg, J. B. Kenney, and M. Gruteser, “Comparing limeric and dcc approaches for vanet channel congestion control,” in *2014 IEEE WiVeC 2014*.
- [35] M. I. Khan and J. Härrri, “Integration challenges of facilities-layer DCC for heterogeneous V2X services,” in *IV 2018, 29th IEEE Intelligent Vehicles Symposium, 26-29 June 2018*.
- [36] H.-J. Günther, R. Riebl, L. Wolf, and C. Facchi, “Collective perception and decentralized congestion control in vehicular ad-hoc networks,” in *Vehicular Networking Conference (VNC), 2016 IEEE*.
- [37] SAE, “SAE J 2945/1 on-board system requirements for v2v safety communications,” 2016.
- [38] ETSI, “ETSI EN 302 665 (2010),” *Intelligent Transport Systems (ITS); Communications Architecture*.
- [39] —, “TS 102 894-1 (2013),” *TS Intelligent Transport Systems (ITS); Users and applications requirements; Part 1: Facility layer structure, functional requirements and specifications*, vol. 1.
- [40] —, “ETSI TS 103 301 V1.1.1 (2016),” *Intelligent Transport Systems (ITS); Vehicular Communications; Basic Set of Applications; Facilities layer protocols and communication requirements for infrastructure services*.
- [41] SAE, “SAE J j2735 dedicated short range communications (dsrc) message set dictionary,” 2009.
- [42] “5.9 ghz dsrc connected vehicles for intelligent transportation systems,” <https://ecfsapi.fcc.gov/file/7520943378.pdf>.

- [43] ETSI, “En 302 636-4-1 intelligent transport systems (its); vehicular communications; geonetworking; part 4: Geographical addressing and forwarding for point-to-point and point-to-multipoint communications; sub-part 1: Media-independent functionality v1.3.1,” *ETSI EN*, 2017.
- [44] —, “ETSI EN 302 636-6-1 V1.2.1 (2014),” *Intelligent Transport Systems (ITS); Vehicular Communications; GeoNetworking; Part 6: Internet Integration; Sub-part 1: Transmission of IPv6 Packets over GeoNetworking Protocols*.
- [45] —, “ETSI EN 302 636-5-1 V2.1.0 (2017),” *Intelligent Transport Systems (ITS); Vehicular Communications; GeoNetworking; Part 5: Transport Protocols; Sub-part 1: Basic Transport Protocol*.
- [46] D. Jiang, Q. Chen, and L. Delgrossi, “Optimal data rate selection for vehicle safety communications,” in *Proceedings of the fifth ACM international workshop on Vehicular Inter-NETworking*. ACM, 2008.
- [47] R. Molina-Masegosa, J. Gozalvez, and M. Sepulcre, “Configuration of the C-V2X Mode 4 Sidelink PC5 Interface for Vehicular Communications,” in *14th Conference on Mobile Ad-hoc and Sensor Networks (MSN 2018)*, 2018.
- [48] A. Mansouri, V. Martinez, and J. Härri, “A first investigation of congestion control for LTE-V2X mode 4,” in *WONS 2019, 15th IEEE Wireless On-demand Network systems and Services Conference, 22-24 January 2019, Wengen, Switzerland*, Wengen, SWITZERLAND, 01 2019.
- [49] ETSI, “ETSI TR 103 319 broadband radio access networks (bran); 5 ghz high performance rlan; mitigation techniques to enable sharing between rlan and road tolling and intelligent transport systems in the 5 725 mhz to 5 925 mhz band.”
- [50] A. Vesco, R. Scopigno, C. Casetti, and C.-F. Chiasserini, “Investigating the effectiveness of decentralized congestion control in vehicular networks,” in *Globecom Workshops (GC Wkshps), 2013 IEEE*.
- [51] J. B. Kenney, G. Bansal, and C. E. Rohrs, “Limeric: a linear message rate control algorithm for vehicular dsrc systems,” in *8th ACM Workshop on Vehicular inter-networking (VANET), 2011*.
- [52] J. B. Kenney, “Dedicated short-range communications (dsrc) standards in the united states,” *Proceedings of the IEEE*, vol. 99, no. 7, pp. 1162–1182, 2011.
- [53] A. Festag, “Cooperative intelligent transport systems standards in europe,” *IEEE communications magazine*, vol. 52, no. 12, pp. 166–172, 2014.
- [54] C.-J. Hsu, J. Fikentscher, and R. Kreeb, “Development of potential methods for testing congestion control algorithm implemented in vehicle-to-vehicle communications,” *Traffic Injury Prevention*, vol. 18, 2017.

- [55] T. Tielert, D. Jiang, Q. Chen, L. Delgrossi, and H. Hartenstein, “Design methodology and evaluation of rate adaptation based congestion control for vehicle safety communications,” in *IEEE Vehicular Networking Conference (VNC), 2011*.
- [56] S. Ruehrup, P. Fuxjaeger, and D. Smely, “Tcp-like congestion control for broadcast channel access in vanets,” in *2014 International Conference on Connected Vehicles and Expo (ICCVE)*. IEEE, 2014, pp. 427–432.
- [57] M. Torrent-Moreno, P. Santi, and H. Hartenstein, “Distributed fair transmit power adjustment for vehicular ad hoc networks,” in *2006 3rd Annual IEEE Communications Society on Sensor and Ad Hoc Communications and Networks*. IEEE, 2006.
- [58] B. Kloiber, J. Harri, and T. Strang, “Dice the tx power—improving awareness quality in vanets by random transmit power selection,” in *Vehicular Networking Conference (VNC), 2012 IEEE*.
- [59] J. T. Willis, A. Jaekel, and I. Saini, “Decentralized congestion control algorithm for vehicular networks using oscillating transmission power,” in *2017 Wireless Telecommunications Symposium (WTS)*. IEEE, 2017, pp. 1–5.
- [60] S. Subramanian, M. Werner, S. Liu, J. Jose, R. Lupoai, and X. Wu, “Congestion control for vehicular safety: synchronous and asynchronous mac algorithms,” in *Proceedings of the ninth ACM international workshop on Vehicular inter-networking, systems, and applications*. ACM, 2012, pp. 63–72.
- [61] M. Joseph, X. Liu, and A. Jaekel, “An adaptive power level control algorithm for dsrc congestion control,” in *Proceedings of the 8th ACM Symposium on Design and Analysis of Intelligent Vehicular Networks and Applications*. ACM, 2018, pp. 57–62.
- [62] S. Rezaei, R. Sengupta, and H. Krishnan, “Reducing the communication required by dsrc-based vehicle safety systems,” in *2007 IEEE Intelligent Transportation Systems Conference*. IEEE, 2007.
- [63] C.-L. Huang, Y. P. Fallah, R. Sengupta, and H. Krishnan, “Intervehicle transmission rate control for cooperative active safety system,” *IEEE Transactions on Intelligent Transportation Systems*, vol. 12, no. 3, pp. 645–658, 2010.
- [64] F. Goudarzi and H. Asgari, “Non-cooperative beacon power control for vanets,” *IEEE Transactions on Intelligent Transportation Systems*, vol. 20, no. 2, pp. 777–782, 2018.
- [65] S. A. A. Shah, E. Ahmed, J. J. Rodrigues, I. Ali, and R. M. Noor, “Shapely value perspective on adapting transmit power for periodic vehicular communications,” *IEEE Transactions on Intelligent Transportation Systems*, vol. 19, no. 3, pp. 977–986, 2018.
- [66] J. Mittag, F. Schmidt-Eisenlohr, M. Killat, J. Härri, and H. Hartenstein, “Analysis and design of effective and low-overhead transmission power control for vanets,” in *Proceedings of the fifth ACM international workshop on VehiculAr Inter-NETworking*. ACM, 2008, pp. 39–48.

- [67] B. Kloiber, J. Härri, T. Strang, S. Sand, and C. R. Garcia, “Random transmit power control for dsrc and its application to cooperative safety,” *IEEE Transactions on Dependable and Secure Computing*, 2015.
- [68] M. Ruffini and H.-J. Reumerman, “Power-rate adaptation in high-mobility distributed ad-hoc wireless networks,” in *Vehicular Technology Conference, 2005. VTC 2005-Spring. 2005 IEEE 61st*.
- [69] R. Baldessari, D. Scanferla, L. Le, W. Zhang, and A. Festag, “Joining forces for vanets: A combined transmit power and rate control algorithm,” in *6th international workshop on intelligent transportation (WIT)*, 2010.
- [70] M. Sepulcre, J. Gozalvez, and B. Coll-Perales, “Why 6 mbps is not (always) the optimum data rate for beaconing in vehicular networks,” *IEEE Transactions on Mobile Computing*, 2017.
- [71] C. B. Math, H. Li, S. H. de Groot, and I. Niemegeers, “A combined fair decentralized message-rate and data-rate congestion control for v2v communication,” in *2017 IEEE Vehicular Networking Conference (VNC)*. IEEE, 2017, pp. 271–278.
- [72] R. Stanica, E. Chaput, and A.-L. Beylot, “Physical carrier sense in vehicular ad-hoc networks,” in *Mobile Adhoc and Sensor Systems (MASS), 2011 IEEE 8th International Conference on*.
- [73] H. Song and H. S. Lee, “A survey on how to solve a decentralized congestion control problem for periodic beacon broadcast in vehicular safety communications,” in *Advanced Communication Technology (ICACT), 2013 15th International Conference on*, 2013.
- [74] X. Liu and A. Jaekel, “Congestion control in v2v safety communication: Problem, analysis, approaches,” *Electronics*, 2019.
- [75] M. Sepulcre, J. Mittag, P. Santi, H. Hartenstein, and J. Gozalvez, “Congestion and awareness control in cooperative vehicular systems,” *Proceedings of the IEEE*, vol. 99, no. 7, pp. 1260–1279, 2011.
- [76] G. Bansal, H. Lu, J. B. Kenney, and C. Poellabauer, “Embarc: Error model based adaptive rate control for vehicle-to-vehicle communications,” in *Proceeding of the tenth ACM international workshop on Vehicular inter-networking, systems, and applications*. ACM, 2013, pp. 41–50.
- [77] C.-L. Huang, Y. P. Fallah, R. Sengupta, and H. Krishnan, “Intervehicle transmission rate control for cooperative active safety system,” *IEEE Transactions on Intelligent Transportation Systems*, 2010.
- [78] M. Sepulcre, J. Gozalvez, O. Altintas, and H. Kremo, “Integration of congestion and awareness control in vehicular networks,” *Ad Hoc Networks*, vol. 37, 2016.
- [79] M. Sepulcre, J. Gozalvez, and M. C. Lucas-Estañ, “Power and packet rate control for vehicular networks in multi-application scenarios,” *arXiv preprint arXiv:1906.07009*, 2019.

- [80] S. Kuhlorgen, A. Festag, and G. Fettweis, "Evaluation of multi-hop packet prioritization for decentralized congestion control in vanets," in *2017 IEEE Wireless Communications and Networking Conference (WCNC)*, 2017.
- [81] S. Kuhlorgen, H. Lu, A. Festag, J. Kenney, S. Gensheim, and G. Fettweis, "Evaluation of congestion-enabled forwarding with mixed data traffic in vehicular communications," *IEEE Transactions on Intelligent Transportation Systems*, 2019.
- [82] G. Bansal and J. B. Kenney, "Achieving weighted-fairness in message rate-based congestion control for dsrc systems," in *2013 IEEE 5th International Symposium on Wireless Vehicular Communications (WiVeC)*. IEEE, 2013, pp. 1–5.
- [83] S. Kuhlorgen, A. Festag, and G. Fettweis, "Evaluation of multi-hop packet prioritization for decentralized congestion control in vanets," in *2017 IEEE WCNC*.
- [84] M. Torrent-Moreno, J. Mittag, P. Santi, and H. Hartenstein, "Vehicle-to-vehicle communication: fair transmit power control for safety-critical information," *IEEE Transactions on Vehicular Technology*, 2009.
- [85] J. Liu, G. Naik, and J.-M. J. Park, "Coexistence of dsrc and wi-fi: Impact on the performance of vehicular safety applications," in *2017 IEEE International Conference on Communications (ICC)*. IEEE, 2017, pp. 1–6.
- [86] G. Naik, J. Liu, and J.-M. J. Park, "Coexistence of dedicated short range communications (dsrc) and wi-fi: Implications to wi-fi performance," in *IEEE INFOCOM 2017-IEEE Conference on Computer Communications*. IEEE, 2017, pp. 1–9.
- [87] B. Cheng, H. Lu, A. Rostami, M. Gruteser, and J. B. Kenney, "Impact of 5.9 ghz spectrum sharing on dsrc performance," in *2017 IEEE Vehicular Networking Conference (VNC)*. IEEE, 2017, pp. 215–222.
- [88] I. Khan and J. Härrri, "Can ieee 802.11p and wi-fi coexist in the 5.9ghz its band?" in *2017 IEEE 18th International Symposium on A World of Wireless, Mobile and Multimedia Networks (WoWMoM)*, June 2017.
- [89] A. Goldsmith, S. A. Jafar, I. Maric, and S. Srinivasa, "Breaking spectrum gridlock with cognitive radios: An information theoretic perspective," *Proceedings of the IEEE*, 2009.
- [90] I. F. Akyildiz, W. y. Lee, M. C. Vuran, and S. Mohanty, "A survey on spectrum management in cognitive radio networks," *IEEE Communications Magazine*, 2008.
- [91] I. F. Akyildiz, W. . Y. Lee, and K. R. Chowdhury, "Crahn's: Cognitive radio ad hoc networks," *Ad Hoc Networks*, 2009.
- [92] B. Wang and K. J. R. Liu, "Advances in cognitive radio networks: A survey," *IEEE Journal of Selected Topics in Signal Processing*, 2011.

-
- [93] E. Z. Tragos, S. Zeadally, A. G. Fragkiadakis, and V. A. Siris, "Spectrum assignment in cognitive radio networks: A comprehensive survey," *IEEE Communications Surveys Tutorials*, 2013.
- [94] S. C. Jha, U. Phuyal, M. M. Rashid, and V. K. Bhargava, "Design of omc-mac: an opportunistic multi-channel mac with qos provisioning for distributed cognitive radio networks," *IEEE Trans. Wireless Commun.*, 2011.
- [95] J. Jia, Q. Zhang, and X. S. Shen, "Hc-mac: A hardware-constrained cognitive mac for efficient spectrum management," *IEEE Journal on Selected Areas in Communications*, 2008.
- [96] K. D. Singh, P. Rawat, and J.-M. Bonnin, "Cognitive radio for vehicular ad hoc networks (cr-vanets): approaches and challenges," *EURASIP Journal on Wireless Communications and Networking*, 2014.
- [97] S. Chen, A. M. Wyglinski, M. Advisor, W. Ece, K. Pahlavan, P. C. Pedersen, and S. K. Jayaweera, "Vehicular dynamic spectrum access: Using cognitive radio for automobile networks," 2013.
- [98] N. Cheng and X. Shen, *Opportunistic Spectrum Utilization in Vehicular Communication Networks*, 2015.
- [99] M. D. Felice, K. R. Chowdhury, and L. Bononi, "Analyzing the potential of cooperative cognitive radio technology on inter-vehicle communication," in *Wireless Days*, 2010.
- [100] M. Di Felice, R. Doost-Mohammady, K. R. Chowdhury, and L. Bononi, "Smart radios for smart vehicles: cognitive vehicular networks," *IEEE Veh. Tech. Mag.*, 2012.
- [101] T. B. et al., "C2c-cc basic system profile. version 1.1.0. car 2 car communication consortium, dec. 2015."
- [102] ETSI, "ETSI ES 202 663 intelligent transport systems (its); european profile standard for the physical and medium access control layer of intelligent transport systems operating in the 5 ghz frequency band."
- [103] "ETSI TR 101 612 intelligent transport systems (its); cross layer dcc management entity for operation in the its g5a and its g5b medium; report on cross layer dcc algorithms and performance evaluation," 2014.
- [104] ETSI, "TS 102 724: Intelligent transport systems (its); harmonized channel specifications for intelligent transport systems operating in the 5 ghz frequency band v1.1.1," 2012.
- [105] ———, "EN 302 571 v1. 1.1 (2008-09) intelligent transport systems (its)," *Radiocommunications equipment operating in the*.
- [106] H. C. Manual, "Highway capacity manual," *Washington, DC*, vol. 2, 2000.
-

- [107] L. Cheng, B. E. Henty, D. D. Stancil, F. Bai, and P. Mudalige, “Mobile vehicle-to-vehicle narrow-band channel measurement and characterization of the 5.9 ghz dedicated short range communication (dsrc) frequency band,” *IEEE Journal on Selected Areas in Communications*, vol. 25, no. 8, pp. 1501–1516, 2007.
- [108] ETSI, “ETSI DRAFT TR 103 562 V0.0.16 (2019),” *Intelligent Transport System (ITS); Vehicular Communications; Basic Set of Applications; Analysis of the Collective Perception Service (CPS)*.
- [109] M. Rondinone et al., “itetris: A modular simulation platform for the large scale evaluation of cooperative {ITS} applications,” *Simulation Modelling Practice and Theory*, 2013.
- [110] T. Higuchi, M. Giordani, A. Zanella, M. Zorzi, and O. Altintas, “Value-anticipating v2v communications for cooperative perception,” in *2019 IEEE Intelligent Vehicles Symposium (IV)*. IEEE, 2019, pp. 1947–1952.
- [111] G. Thandavarayan, M. Sepulcre, and J. Gozalvez, “Analysis of message generation rules for collective perception in connected and automated driving,” in *2019 IEEE Intelligent Vehicles Symposium (IV)*. IEEE, 2019, pp. 134–139.
- [112] A. Mansouri, V. Martinez, and J. Härri, “A first investigation of congestion control for lte-v2x mode 4,” in *WONS 2019, 15th IEEE Wireless On-demand Network systems and Services Conference*, 2019.
- [113] C. Campolo, A. Molinaro, A. Iera, and F. Menichella, “5g network slicing for vehicle-to-everything services,” *IEEE Wireless Communications*, vol. 24, no. 6, pp. 38–45, 2017.
- [114] Z. C. Lipton, J. Berkowitz, and C. Elkan, “A critical review of recurrent neural networks for sequence learning,” *arXiv preprint arXiv:1506.00019*, 2015.
- [115] S. Hochreiter and J. Schmidhuber, “Long short-term memory,” *Neural computation*, vol. 9, no. 8, pp. 1735–1780, 1997.
- [116] “itetris: A modular simulation platform for the large scale evaluation of cooperative {ITS} applications,.”
- [117] ETSI, “TR 102 863 v1. 1.1 local dynamic map (ldm)-rational for and guidance on standardization,” 2011.