



Slicing and orchestration in service-oriented 5G architecture

Navid Nikaein

Assistant Professor at Eurecom

Founder of Mosaic5G initiative

Plenary keynote at IEEE/IFIP WONS 2018

6-8 February 2018, Isola 2000, France



Connected, Controlled, and Flexible

Digital Society

Value Creation

Consistent experience

Sustainable business model

What is 5G?



V2X is a critical component to our vision
Giving vehicles the ability to communicate with each other and beyond

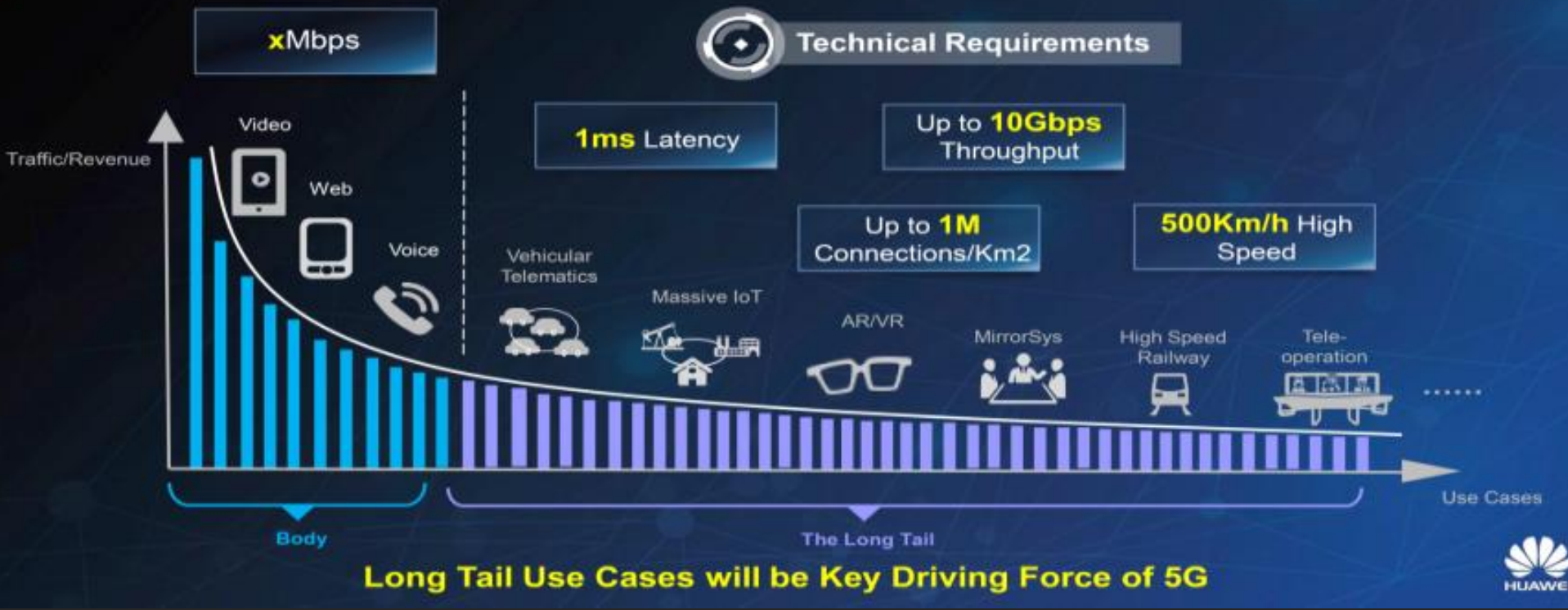

Not a one-size fits all

Turn physical infrastructure into multiple logical networks

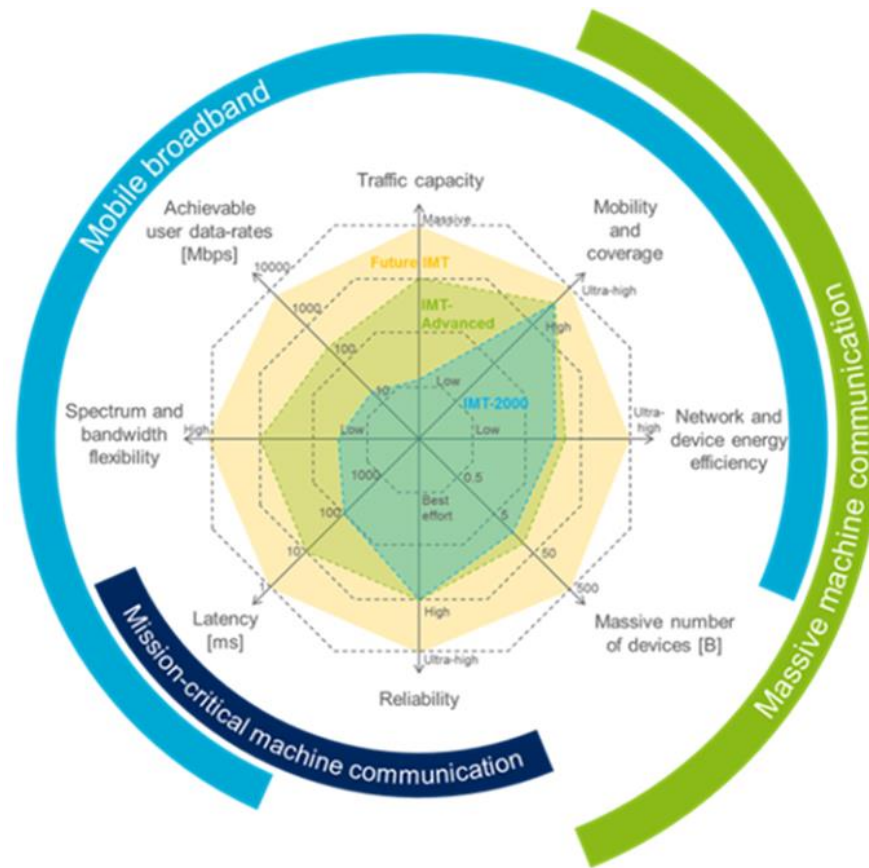

Service-Oriented 5G

Today's 4G is designed for limited number of UCs

Throughput-optimized
Fixed
Rigid

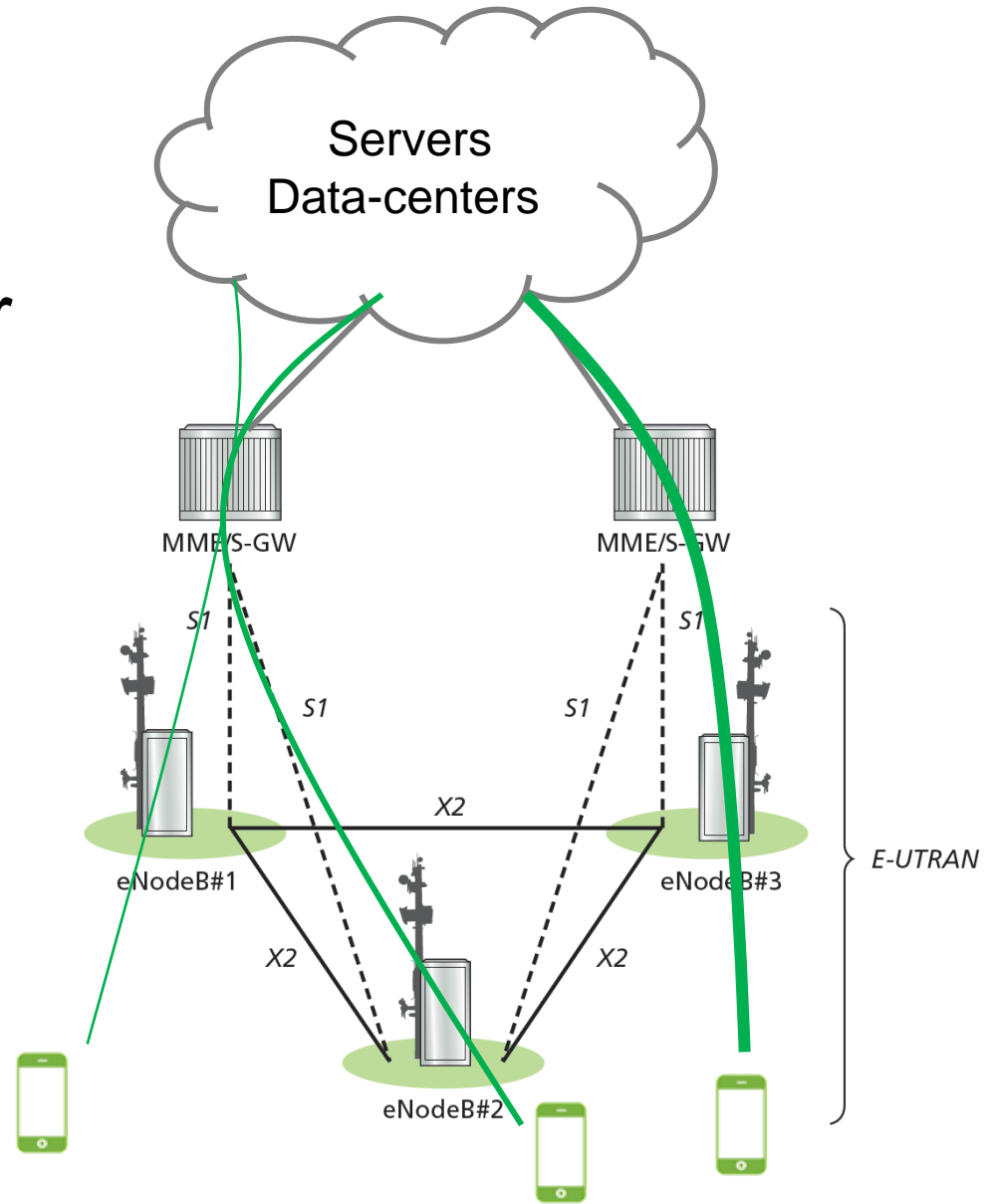

Communication-oriented 4G

Mindful about
3GPPP facts and figures

- 514 Companies from 45 Countries
- 50,000 delegate days per year
- 40,000 meeting documents per year
- 1,200 specifications per Release
- 10,000 change requests per year

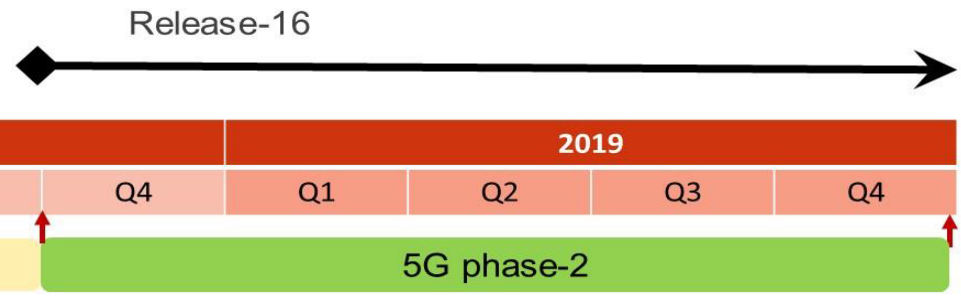
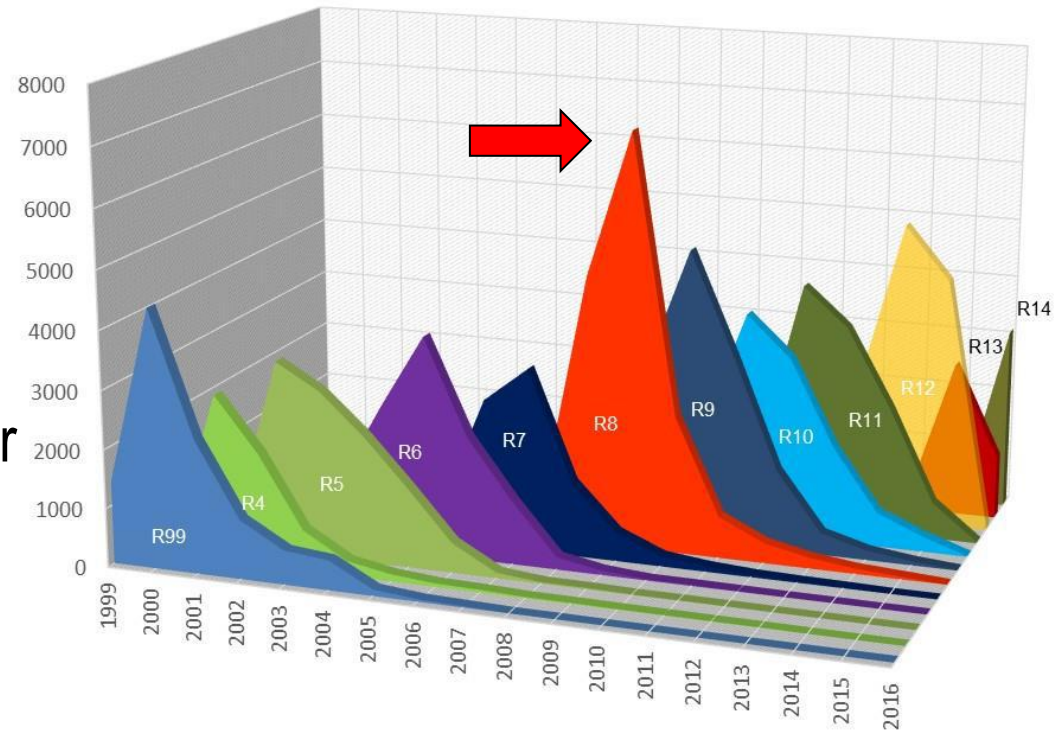

Communication-oriented 4G

Future mobile network will look
fundamentally different

There will be no “one-size-fits-all”
architecture

Like it or not

Service-oriented 5G

Flexible and Customizable for each use-cases

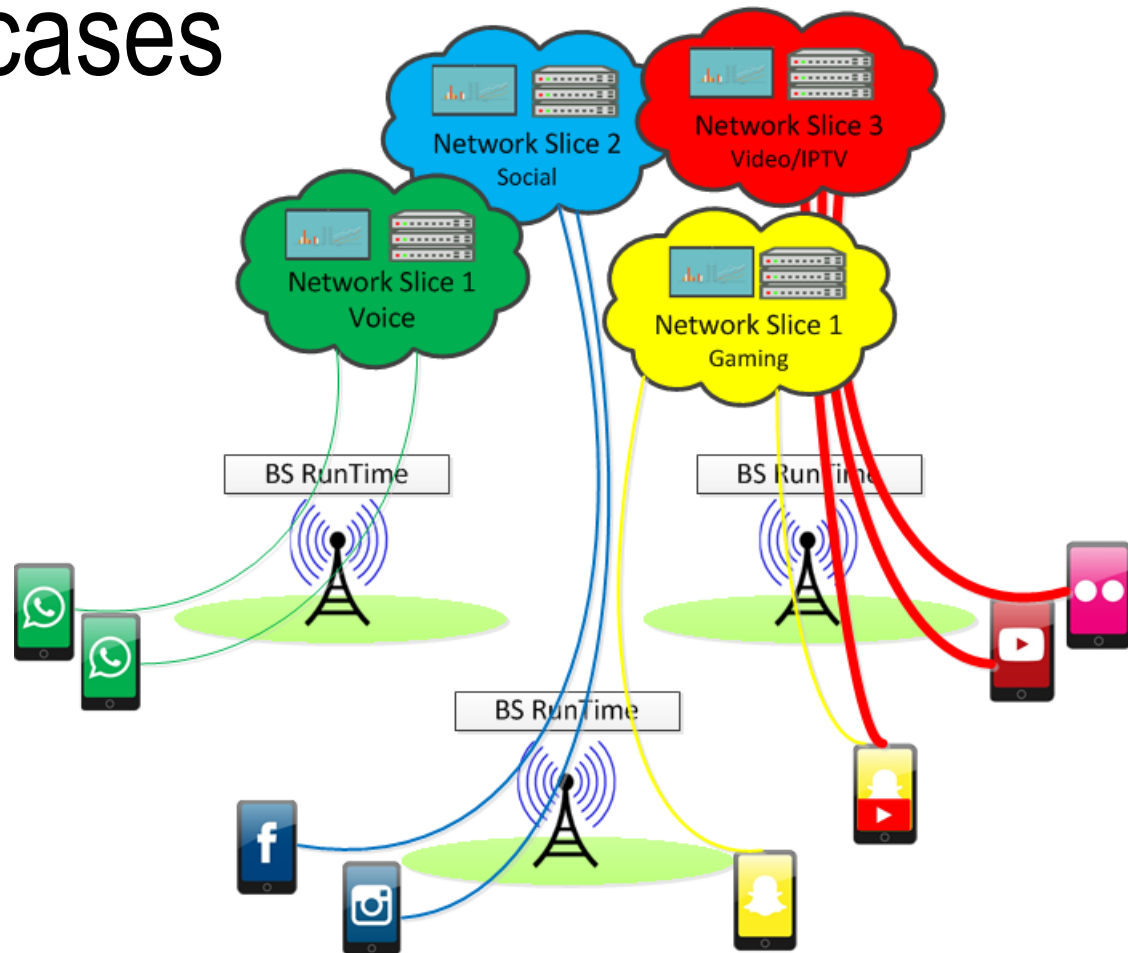
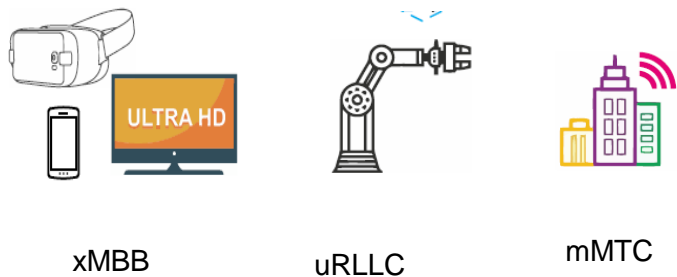

Service-oriented 5G

Trends

Softwarization
Virtualization
Disaggregation

Service-oriented architecture



Service-oriented 5G

Why will it happen?

Extreme network flexibility and
modularity

Service-oriented 5G



3GPP re-architects mobile networks

	3G	4G	5G
Downlink waveform	CDMA	OFDM	OFDM, SCFDMA
Uplink waveform	CDMA	SCFDMA	OFDMA, SCFDMA
Channel coding	Turbo	Turbo	LDPC (data) / Polar (L1 contr.)
Beamforming	No	Only data	Full support
Spectrum	0.8 – 2.1 GHz	0.4 – 6 GHz	0.4 – 90 GHz
Bandwidth	5 MHz	1.4 – 20 MHz	Up to 100 MHz (400MHz for >6GHz)
Network slicing	No	No	Yes
QoS	Bearer based	Bearer based	Flow based
Small packet support	No	No	Connectionless
In-built cloud support	No	No	Yes

Service-oriented 5G

5G 3GPP re-architects mobile networks

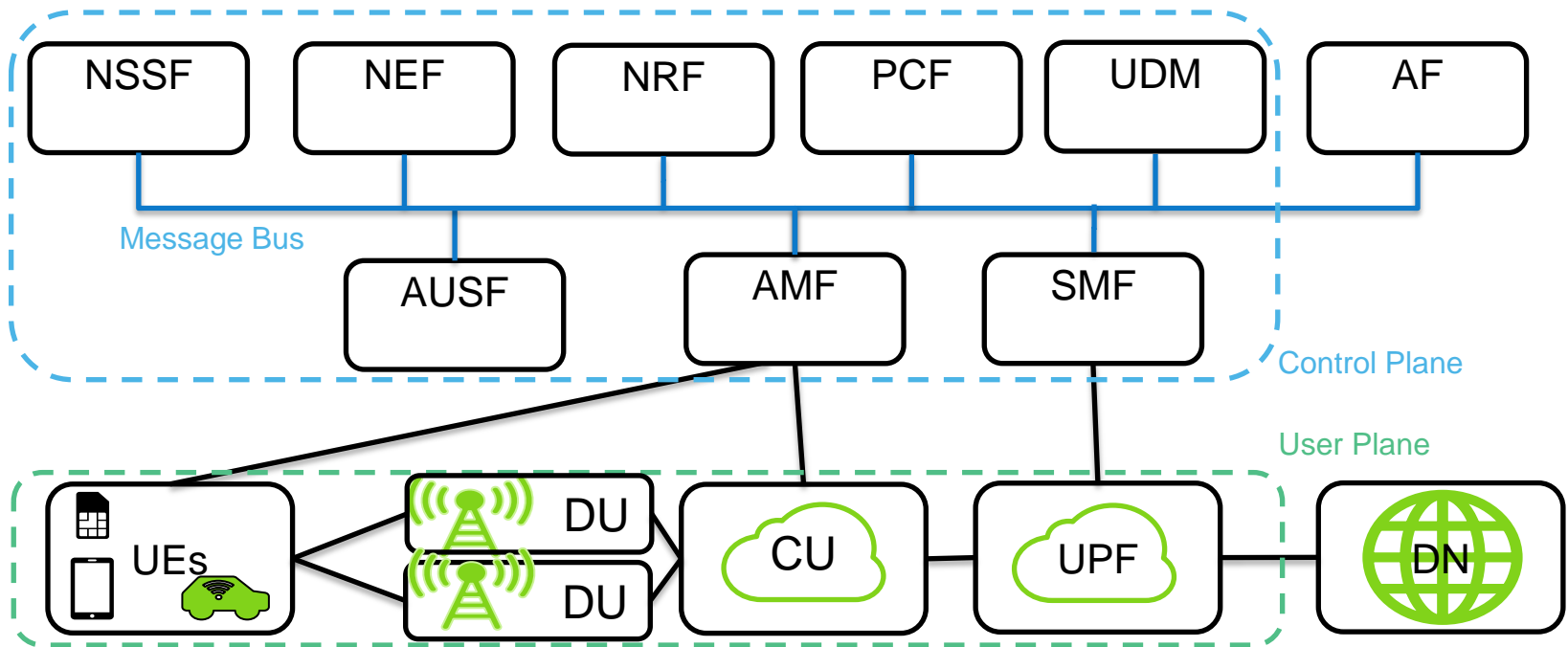

AMF	Access & Mobility Management Function	SMF	Session Management Function
AUSF	Authentication Server Function	UPF	User Plane Function
NRF	Network Repository Function	AF	Application Function
UDM	Unified Data Management	PCF	Policy Control Function
DN	Data Network	NEF	Network Exposure Function

Service-oriented 5G



3GPP Role Model

E.g.: End user,
Small & Medium Enterprise,
Large enterprise,
Vertical,
Other CSP, etc.

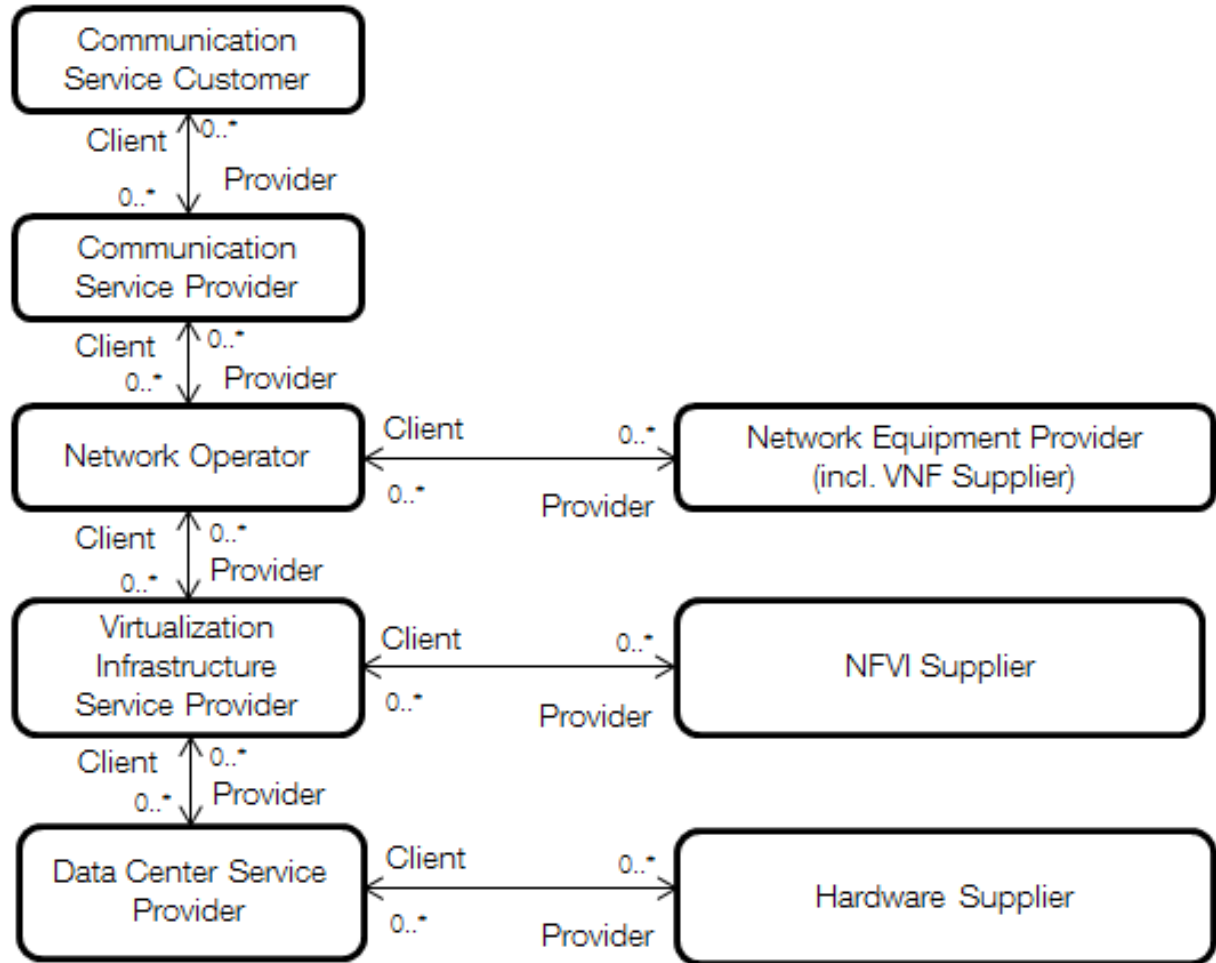

Service-oriented 5G



Shared Resources?



Isolated Resources?



DevOps

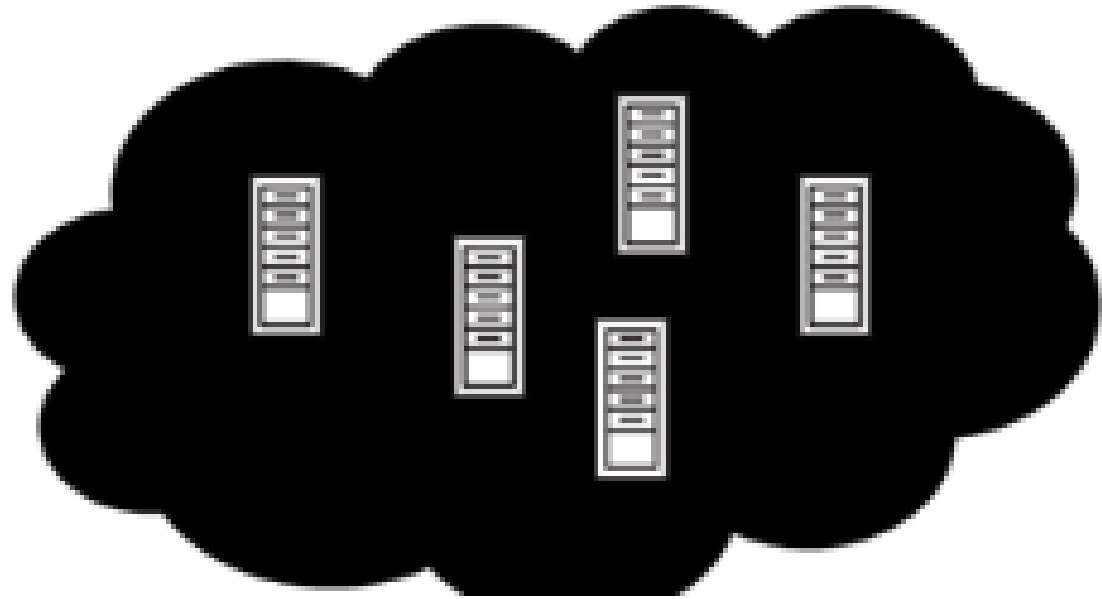

Automation-Orchestration

the phase change of modern software

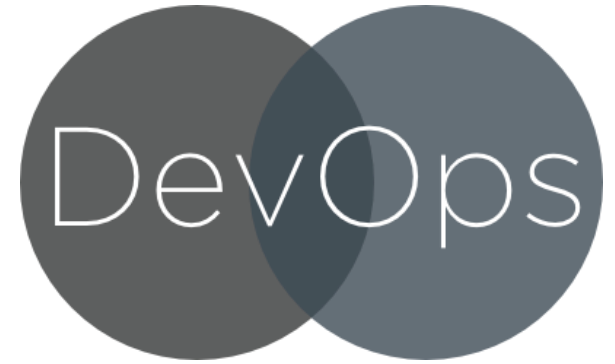

Operation cost

Software cost

Free software is becoming expensive

Automation-Orchestration

LifeCycle Management (Encapsulate operation)

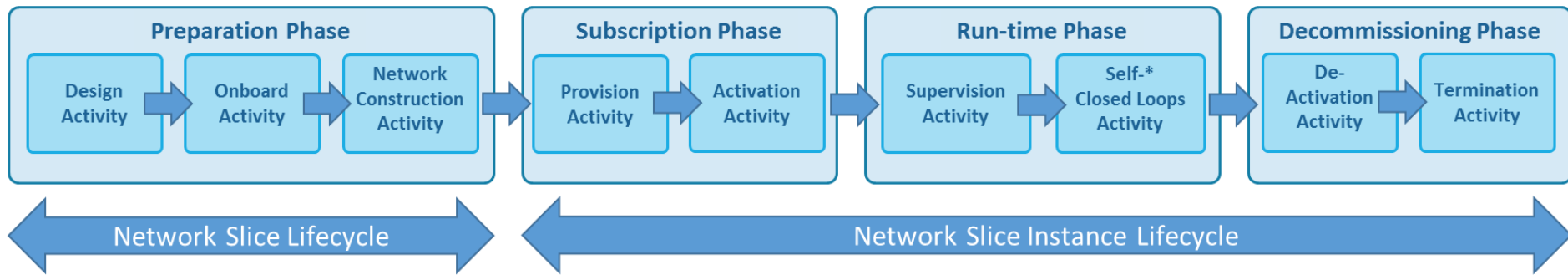
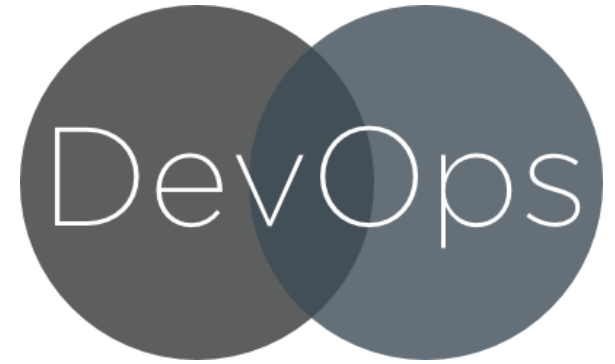

Automation-Orchestration

LifeCycle Management (Encapsulate operation)

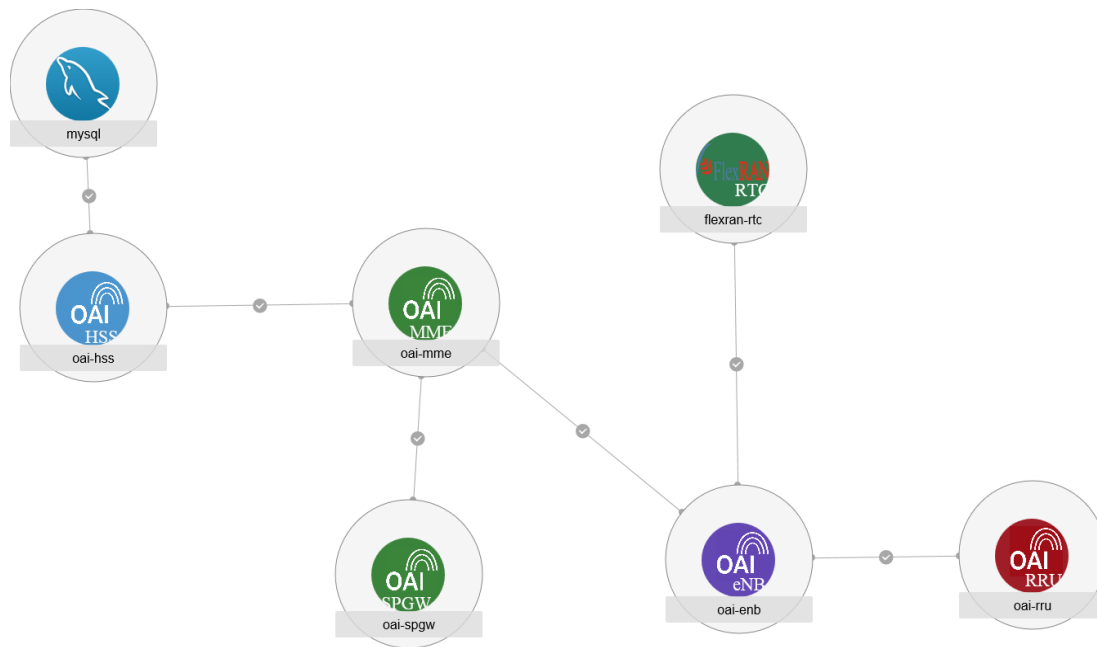
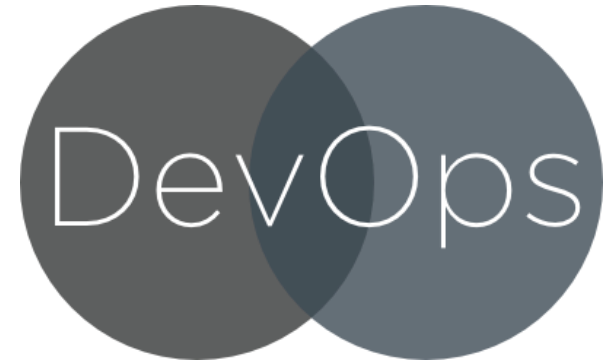

- installation
- configuration
- connections
- upgrades and updates
- scale-out and scale-back
- health checks
- operational actions
- benchmarks

<https://jujucharms.com/q/oai>

Automation-Orchestration

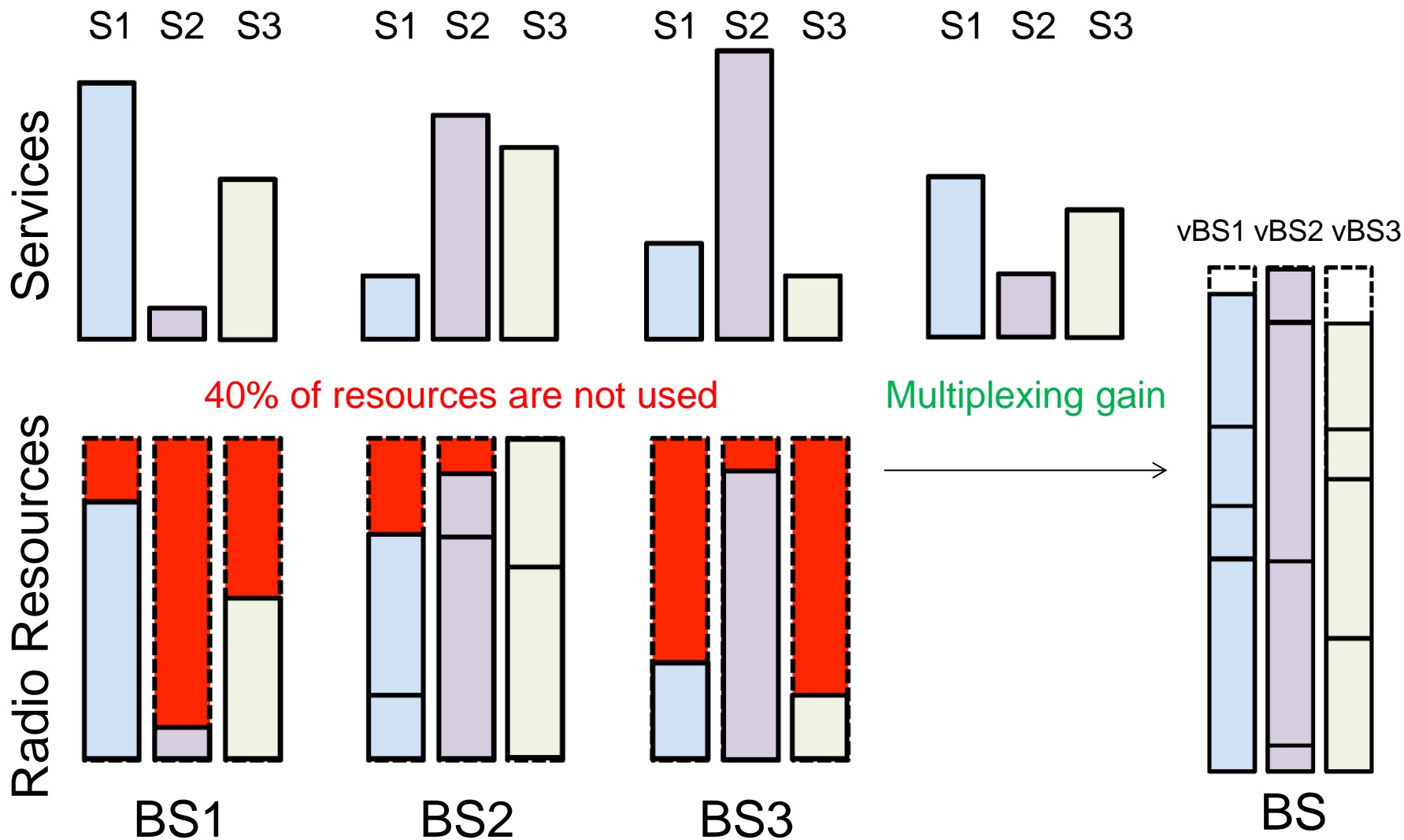

Disaggregation

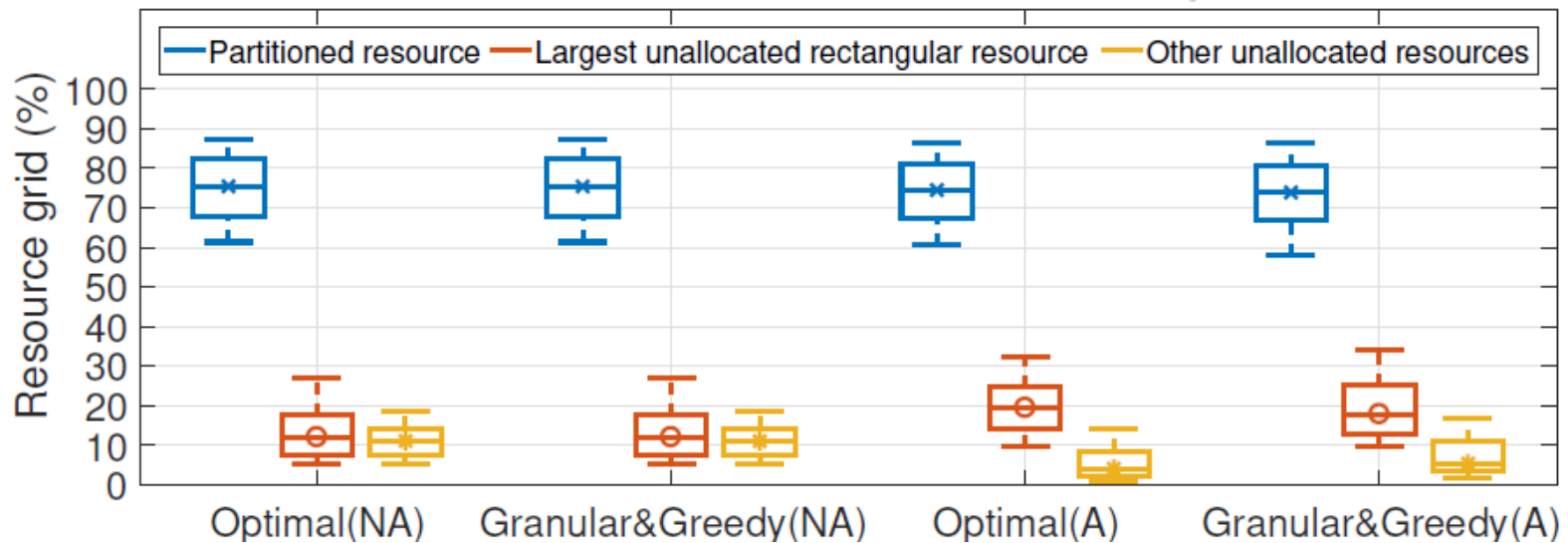
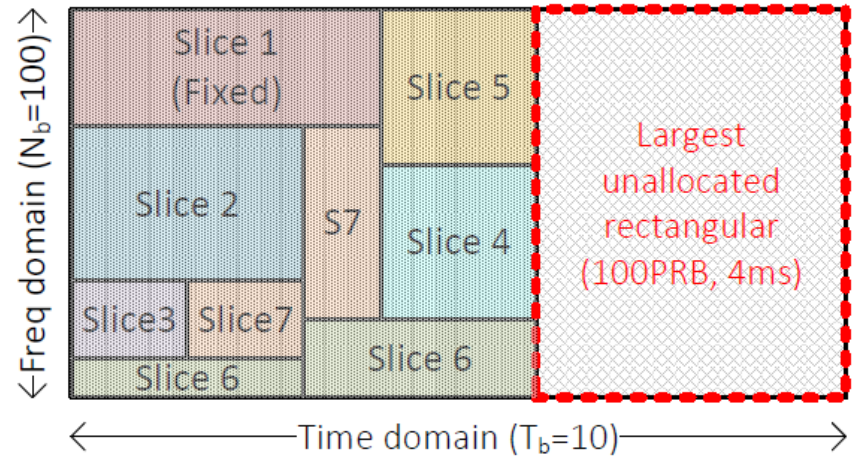
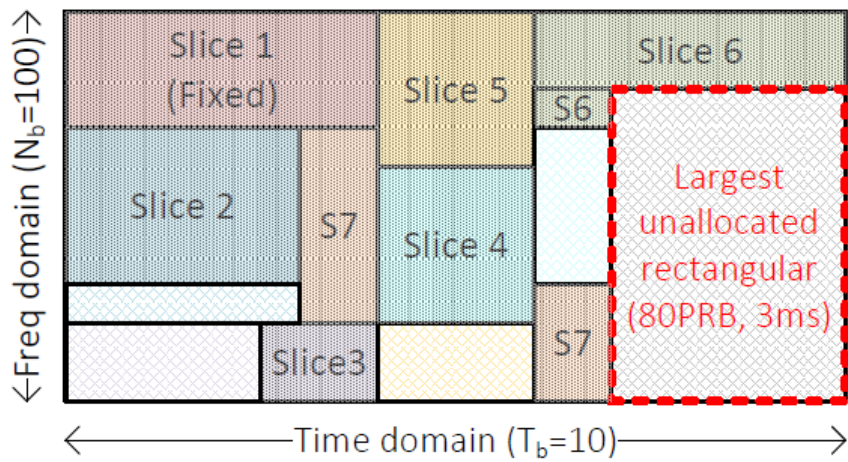

Multiplexing Gain

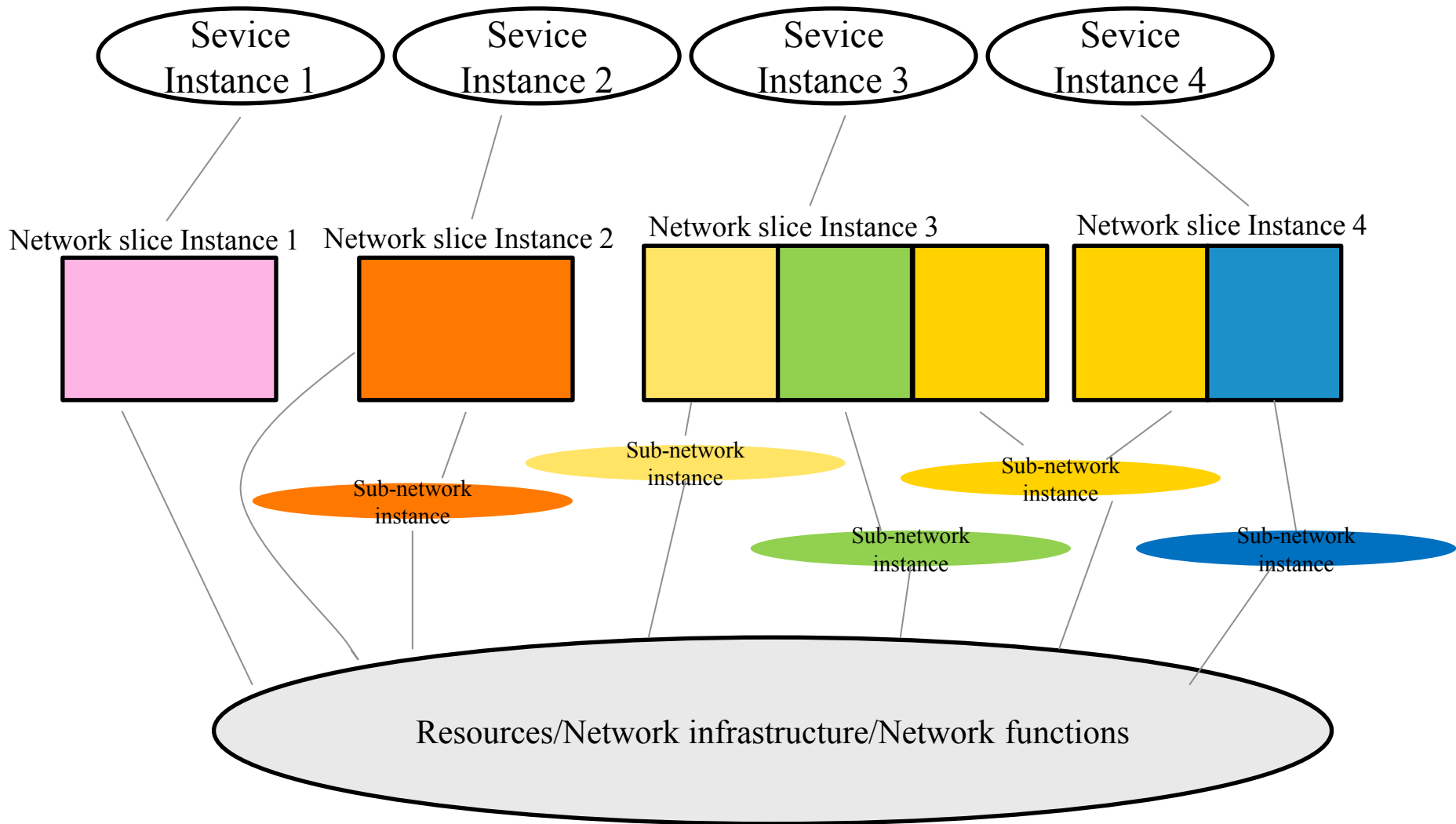

Network Slicing Concept

Turn physical infrastructure into multiple logical networks on top of a partially shared network infrastructure

Each instance of a network slice represents an independent end-to-end network

Efficient sharing of radio and spectrum resources

Functional and performance isolation

Plug & Play CP/UP customization

API

Cognition

Foundations

Network Slicing Concept

NFV
Cloud Infra

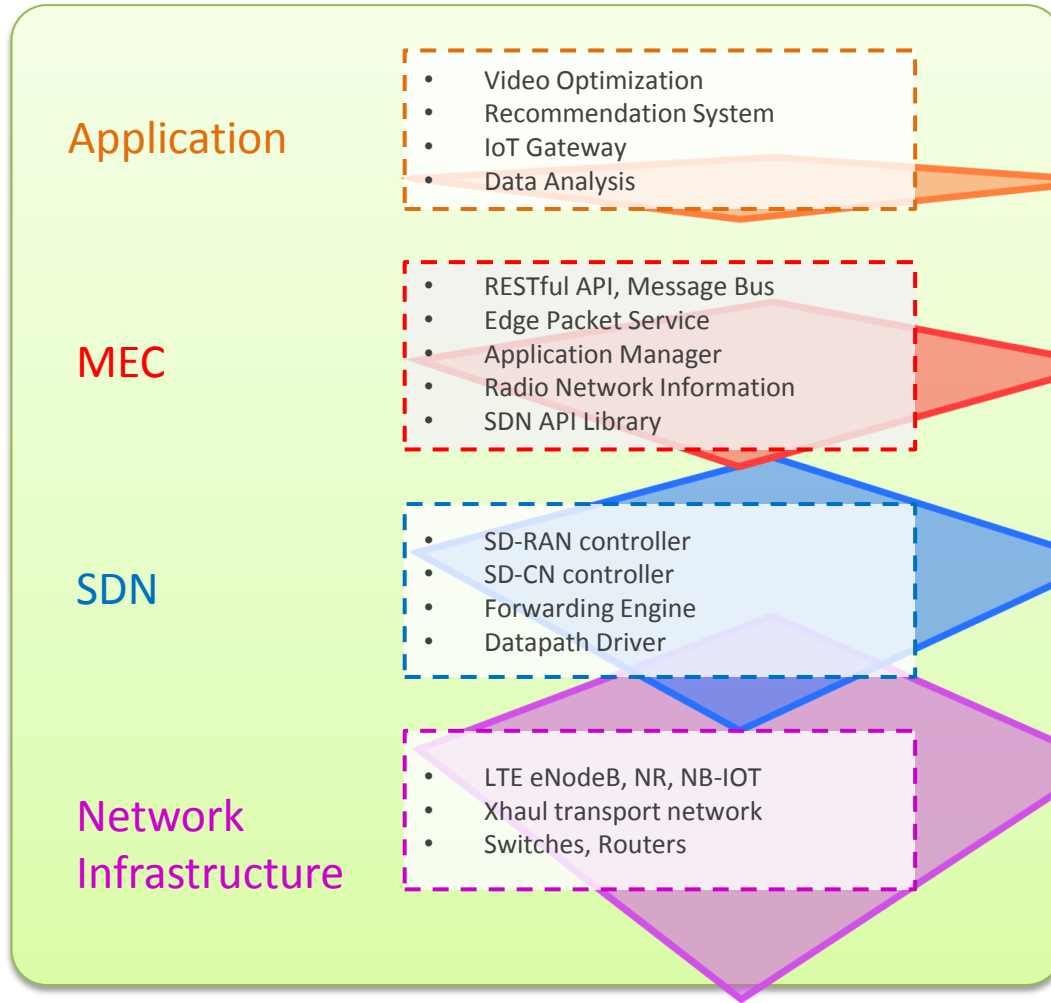

Enabling Technologies

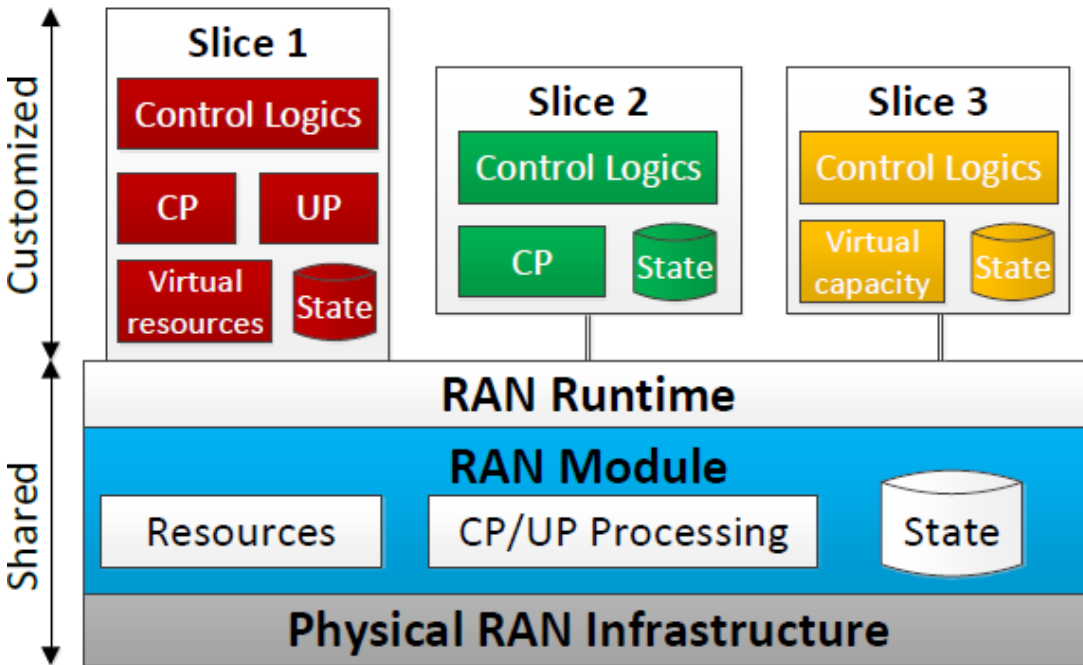

Service provider: owner of data with isolated and customized services

Runtime: multi-service execution environment allowing to monitor and control the behavior of the underlying RAN resources, states, and functions

Infrastructure: including RAN module, physical infrastructure, and radio spectrum

RAN Slicing System

Inter-Slice Resource Partitioning

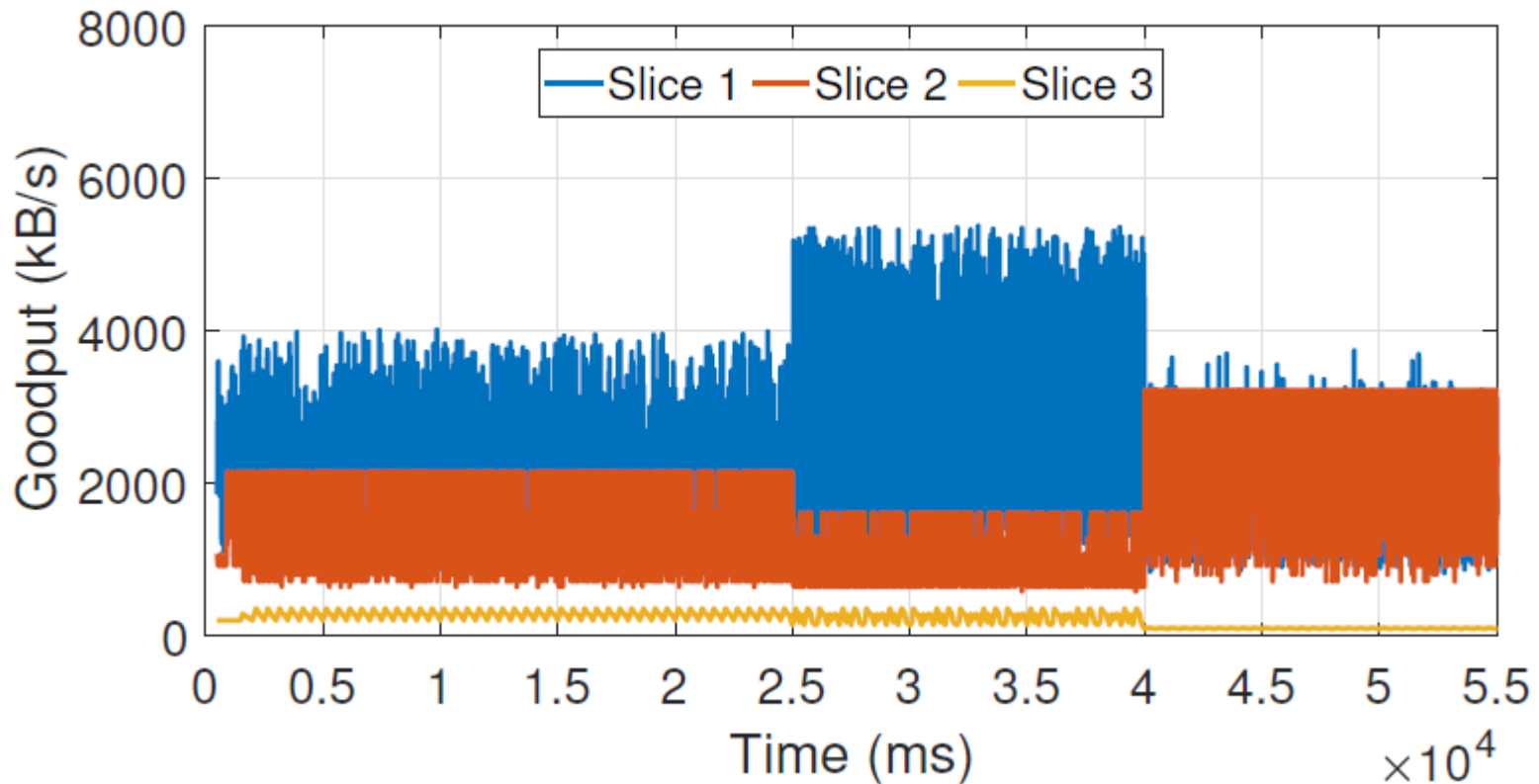

RAN Slicing

Function customization in Monolithic BS

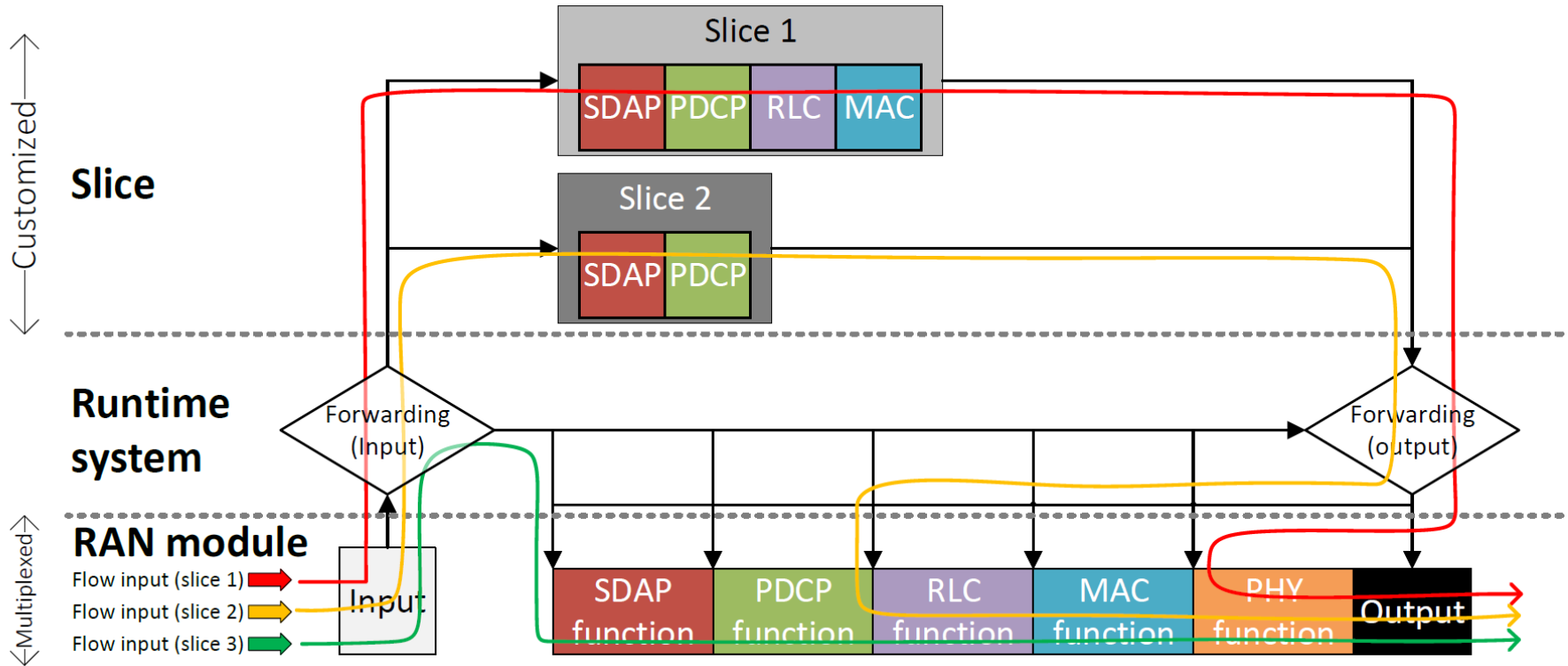

RAN Slicing Example

Maximize the multiplexing gain

Isolate tenants resources

customize tenant resources

Benefit of Slicing

What is the typical number of slices?

What is the typical lifetime of a slice?

Two numbers in Slicing

Why such a big complexity to support slicing?

Is the net neutrality principles retained ?

Two questions in Slicing

Realtime control and coordination in RAN and CN

Tradeoff between slice isolation and resource sharing

Security control across many logical networks and abnormality detection

Pattern recognition and correlation to support QoS-QoE

Predict network behavior if a given control logic is applied

Automate failover and network health monitoring and prediction

Dynamic guarantees as a function of cost /adaptive/probabilities

Example Research Areas

Need for agile network service delivery platforms and use-cases for 4G-5G R&D



Consume 5G service

Build 5G service and open APIs

Host 5G service

Opensource Platforms

Agile network service delivery platforms



A Flexible & Programmable
SD-RAN Platform



A Low Latency SDN-based
MEC Platform



An event-driven juju-based
service orchestrator core



A Flexible & Programmable
SD-CN Platform



Network function & application
distribution Repository



Remotely accessible
experimentation testbed

Mosaic5G.io Ecosystem

Agile network service delivery platforms

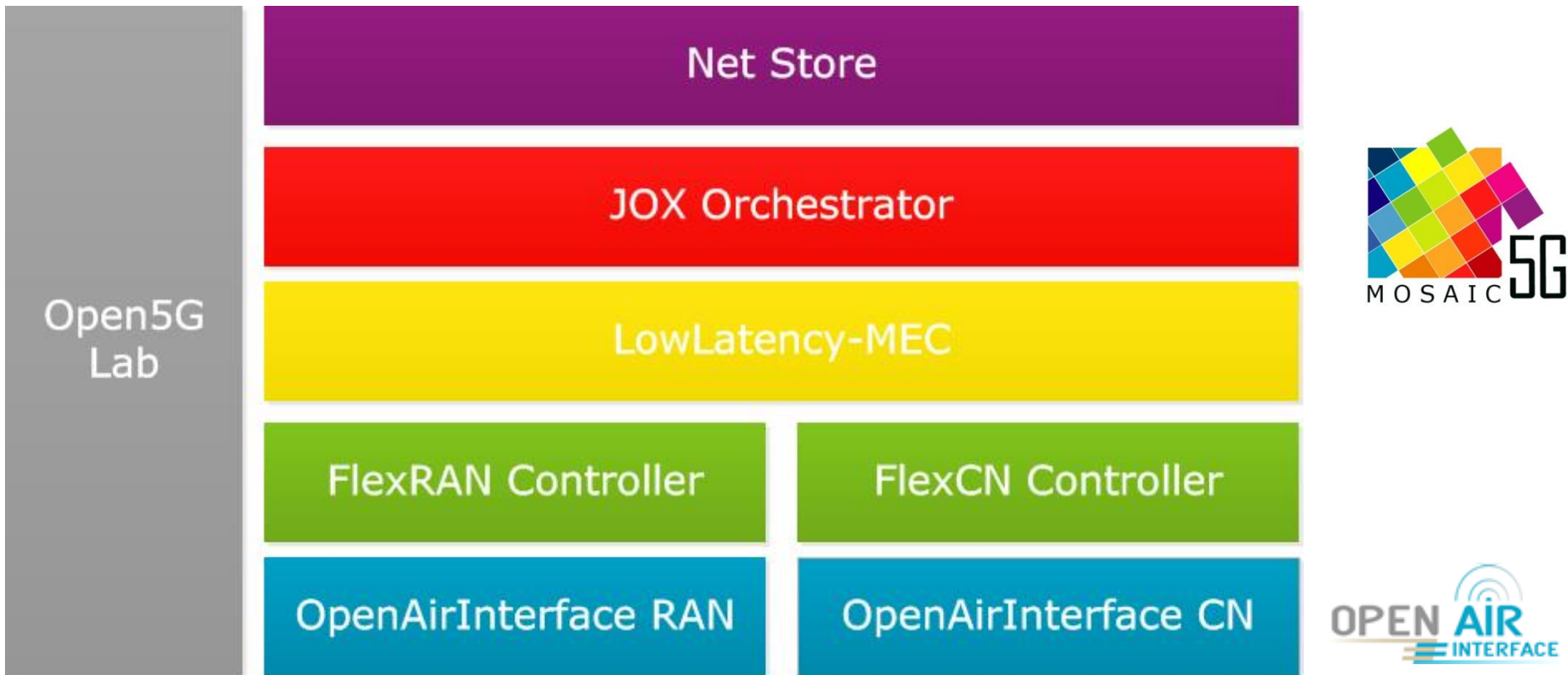

Mosaic5G.io Ecosystem

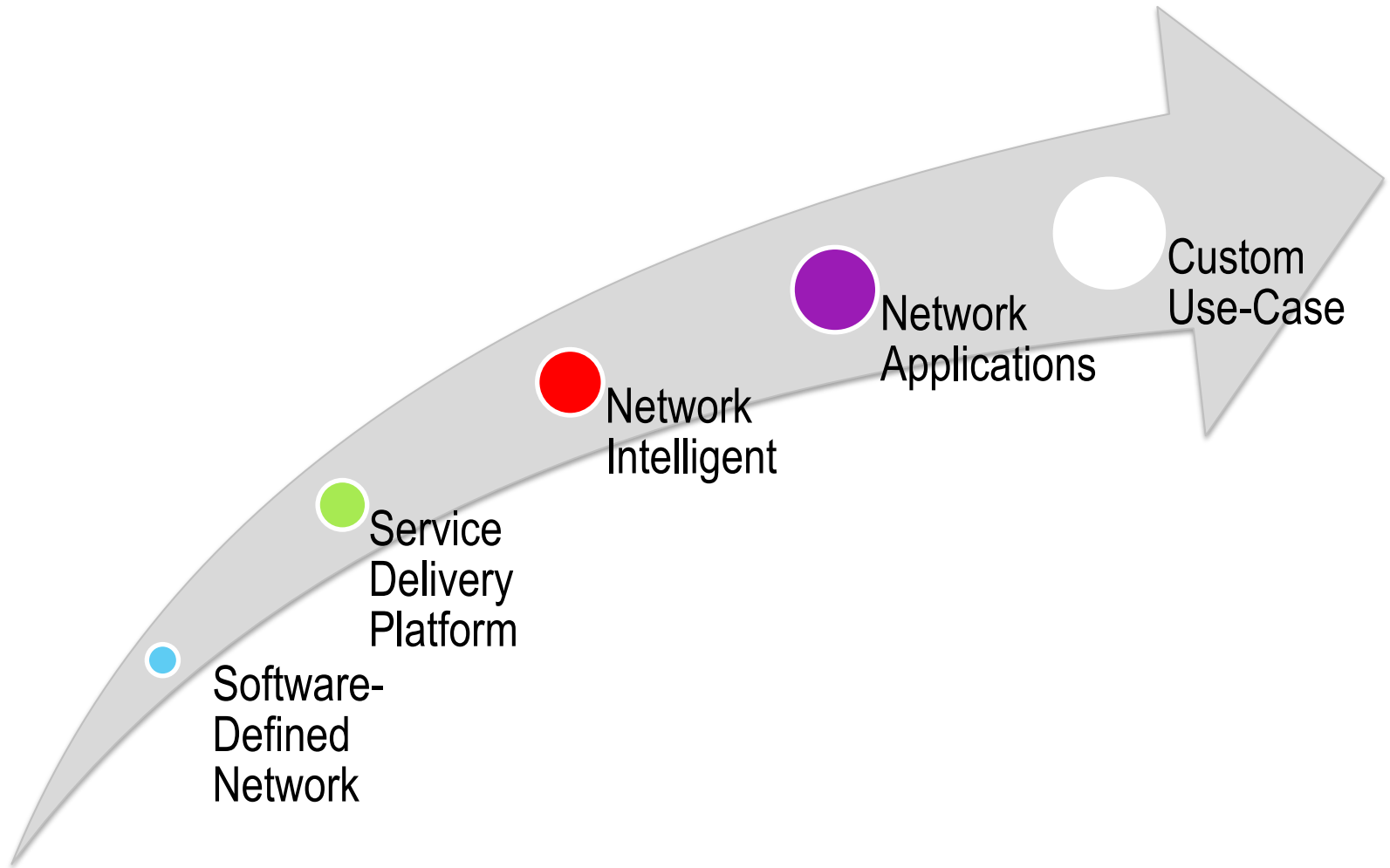

Mosaic5G.io Objectives



MWC 2016, 2017



ITU, FG-13, 2016, 2017



ETSI 2016, 2017



EUCNS 2015, 2016, 2017



OPNFV 2016



Mobicom 2014, 2016, 2017

Success Stories

- Mail : contact@mosaic-5g.io
- Website : mosaic-5g.io
- Twitter: @mosaic5g

Info

